





# THUNDER GROUP<sup>®</sup>

[www.thundergroup.com](http://www.thundergroup.com)

**NEW YORK BRANCH**  
33 Truman Drive South  
Edison, NJ 08817  
Tel: (732) 777-1977  
Fax: (732) 777-0117  
eFax: (626) 551-0388

**CORPORATE - CALIFORNIA**  
780 South Nogales Street  
City of Industry, CA 91748  
Tel: (626) 935-1605  
Fax: (626) 935-1609

**TEXAS BRANCH**  
10702 Cash Road  
Stafford, TX 77477  
Tel: (713) 690-0111  
Fax: (713) 690-0123  
eFax: (626) 465-4692

**ILLINOIS BRANCH**  
8402 #E West 183rd Street  
Tinley Park, IL 60487  
Tel: (855) 395-5560  
Fax: (708) 429-7125

**FLORIDA BRANCH**  
10599 NW 67th Street  
Tamarac, FL 33321  
Tel: (954) 724-5214  
Fax: (954) 337-0222



# Product Categories

Melamine  
Dinnerware

8



Asian  
Cookware

168



Asian  
Tableware

180



Bakeware  
& Supplies

188

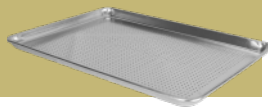

Bar  
Supplies

202



Catering &  
Buffetware

222



Food  
Preparation

232



Gas &  
Electric

260



Janitorial  
Services

266



Kitchen  
Utensils

276



Professional  
Cookware

308



Table Top  
Services

320



Signage  
Accessories

358



Shelving  
Units

362



Stainless Steel  
Worktables

366



Index By  
Item Number

371



Icon Legend on page 370

<b>A</b>	Airpot	332
	Aluminum	
	Sheet Pan Truck	191
	Layer Cake Pan	194
<b>B</b>	Bag, Pizza	200
	Bagger, French Fry	281
	Baller, Melon, Deluxe	234
	Bar Caddy	212
	Bar, Adaptor	235
	Basin	
	Aluminum	168
	Polar, Stainless Steel	301
	Sushi Basin, Plastic	181
	Basket	
	Breeding	305
	Donut Basket	254
	Fry, Wire	319
	Handwoven	338
	Plastic	301, 339
	Steamer, Aluminum	313
	Taco Bowl / Basket	281
	Tostada	281
	Bell, Table	326
	Bento Box, Makinouchi Bento Server	181
	Bins, Ingredient	249
	Board	
	Cutting, Rectangular	250
	Color Coded	251
	Fajita Board	343
	Heavy Duty	250
	Boards	250
	Ping Pong	250
	Round	250
	Booster Seat	357
	Bottle	
	Pourers	216 to 219
	Squeeze, Plastic	334
	Bowl	
	Cascading	12, 20, 46, 54
	Donburi With Handle	146
	Miso Soup, Melamine	146
	Miso Soup, Wood	180
	Mixing	299
	Nabemono Bowl, Cast Iron	182
	Rice, Wood	180
	Salsa	336
	Shabu Shabu Bowl, Cast Iron	182
	Soba	146
	Soba Noodle, Melamine	146
	Woven Wood	337
	Box	
	Cutlery	274
	Knock Box, Coffee	331
	Pizza Dough	248
	Brush	
	Decanter	331
	Cutting Board	252
	Pastry, Boar	259
	Pastry, Nylon	259
	Wire	307
	Wok	307
	Bucket, Wine Bucket, Stainless Steel	221
	Buffetware	229
	Burner	
	Duck Burner	178
	Jet Burner	178
	Bus Box	272
	Bus Cart	273
	Bus Cart Bin	273
	Bus Trays	274

<b>C</b>	Can, Trash	271
	Card Number, Plastic	322
	Catcher, Cap	209
	Chafer	
	Continental	223
	Deluxe	222
	Economy	226
	Gold Accented	224
	Marmite	222
	Parts & Accessories	227
	Roll Top	222, 225
	Stackable	225
	Check Cover	325
	Check Spindle	326
	China Cap	302
	Chopstick	
	Melamine	187
	Plastic	187
	Colander	
	Aluminum	300
	Asian Style	169
	Plastic	301
	Stainless Steel	300
	Compartment, Stainless Steel	210
	Condiment, Stainless Steel	210
	Condiment Jar & Accessories	322
	Cone, Safety	270
	Container	
	Food Storage	239 to 249
	Food Storage Lid	239 to 249
	Insulated Rice Container	185
	Rice Container	185
	Cookware	
	7 Piece Set, Stainless Steel	311
	Brazier, Aluminum	310
	Double Boiler, Aluminum	317
	Pastas, Aluminum	315
	Saute Pan/Lid	314
	Stainless Steel	308 to 311
	Stock Pot, Aluminum	312, 313
	Turkey Pot, Aluminum	317
	Cool Handle	318
	Cover	
	Divided, Stainless Steel	233
	Plate	231
	Sheet Pan	191
	Wok	174
	Cracker, Lobster	345
	Creamer, Bell	329
	Cruet, Oil & Vinegar	321
	Crumber, Table	334
	Cup	
	French Fry	327
	Malt	213
	Sauce	327
	Cutter	
	Cheese	253
	Croissant Cutter	201
	French Fry	280
<b>D</b>	Decanter	208
	Dipper	279
	Disher	276 to 277
	Dishes	
	Au Gratin	328
	Sherbet	328
	Swirl, Dessert	339
	Dispenser	
	Beverage	248
	Juice	228
	Napkin	321
	Stirrer / Straw	321



Melamine			
Arcadia	22 to 24		
Black Pearl	74 to 77		
Blue Bamboo	127 to 134		
Blue Dragon	92 to 97		
Blue Jade	156 to 158		
Classic Black	10 to 13		
Classic Red	14 to 17		
Classic White	18 to 21		
Color Green	28 to 31		
Color Ivory	32 to 35		
Color Orange	36 to 39		
Color Pure Red	40 to 43		
Color Purple	44 to 47		
Color White	48 to 51		
Color Yellow	52 to 55		
Gold Orchid	135 to 139		
Gold Pearl	78 to 80		
Gastronorm Pans	166 to 167		
Graham	64 to 68		
Imperial	98 to 102		
Jazz	69 to 73		
Longevity	103 to 108		
Lotus	109 to 114		
Nustone Tan	56 to 59		
Nustone White	60 to 63		
Passion Pearl	83 to 85		
Passion Red	86 to 88		
Passion White	89 to 91		
Peacock	115 to 120		
Rose	121 to 126		
San Marino	25 to 27		
Serving Utensil	64 to 65		
Tenmoku	140 to 144		
Urushi Spray	147 to 148		
Wei	149 to 155		
Menu Cover	324, 325		
Mixing Paddle			
Stainless Steel	253		
Wood	253		
Mop			
Handle & Buckets	270		
Holder	266		
Muddler	211		
<b>N</b> Noodle Machine	253		
Nozzle, Burner	178		
<b>O</b> Opener			
Bottle	209		
Can	209		
Punch Can	209		
Rotary Can	209		
Table Mount Wine Opener	209		
Table Mount Can Opener	306		
<b>P</b> Pads & Bristles, Scrubbing	275		
Pail	237		
Pan			
Bake Pan, Aluminum	189		
False Bottom, Stainless Steel	236		
Food Pan/Lid, Polycarbonate	242 to 245		
Food Pan Drain Shelf, Poly	243, 245		
Fry Pan, Aluminum	318		
Inset	237		
Layer Cake, Aluminum	194		
Muffin, Aluminum	189		
Muffin, Carbon Steel	189		
Sauce Pan/Pot, Lid Aluminum	316		
Sheet, Aluminum	190		
Sheet, Stainless Steel	190		
Snow Flat Pan	176		
Spillage, Stainless Steel	236		
Steam Pan	232, 233,		
Steam Pan Lid	233		
Steam Pan, Perforated	233		
Water Pans, Aluminum	236		
Peel, Pizza	200		
Peeler	282		
Pie Marker	193		
Pitcher			
Milk	329		
Syrup	327		
Water	204		
Plate			
Adaptor, Stainless Steel	235		
BBQ Plate - Cast Iron	176		
Sushi Plate	183		
Platter			
Fish, Melamine	186		
Oval, Stainless Steel	230		
Sizzling	344		
Underliner, Bakelite	344		
Plunger	270		
Portion Controller	278		
Pot			
Bain Marie	237		
Insulated Sushi Rice	179		
Tea	330		
<b>R</b> Rack			
Cutting Board	252		
Dunnage	274		
Hand Roll, Plastic	181		
Icing/Cooling Rack	255		
Knife	258		
Pizza	252		
Steam, Round	254		
Wok	174		
Rail, Stainless	210		
Ramekin			
ABS	327		
Melamine	159 to 163		
Plastic	162		
Rice Cloth	256		
Rice Cooker			
Electric	263		
Gas	262		
Ricer, Potato	295		
Rimmer, Salt And Sugar Glass	212		
Roller Docker	201		
Rolling Pin			
Aluminum	201		
Wood	201		
Wood Rolling Pin Asian Style	168		
<b>S</b> Scales			
Chinese Catts, Bowl Platform	256		
Scales, Flat Platform	256		
Scissors	105		
Scoop			
Aluminum	283		
Polycarbonate	283		
Scrap Block	275		
Scraper			
Plastic	298		
Silicon	298		
Stainless Steel	298		
Screen			
Donut, Square	254		
Fryer	255		
Pizza Screen, Aluminum	199		
Sealing Machine	261		

Server			Sushi Roller	187
Coffee	333		Sushi Server, Shiraki Wood	183
Pie	193		Sweeper	
Swirl Double Wall	333		Crumb	334
Vacuum	331		Dust Pan	269
Shaker			<b>T</b> Tea Ball	330
Cocktail, Stainless Steel	213		Tenderizer, Meat	295
Salt & Pepper, Glass	320		Thermometer	
Shot, Plastic	208		Dial with hook	257
Swirl Cheese, Glass	320		Dial Pocket	257
Shelving			Dial Deep Fry	257
Chrome Plated	362		Dial Meat	257
Epoxy Coated	363		Liquid Deep Candy	258
Parts / Accessories	362, 363		Liquid Oven	258
Sifter, Flour, Stainless	201		Liquid Scale Horizontal	258
Sign,			Timer 60 mins	256
Caution	270		Toilet Seat Paper	206
Chain	331		Tong	
Tent	330		Bar	211
Signage	358 to 361		Cake	293
Information with Symbols			Hamburger	293
Information with Symbols and Braille			Pastry	293
Skewer			Pom	293
Bamboo	169		Polycarbonate	291
Stainless Steel	297		Stainless Steel	292, 294
Skimmer			Toothpicks	183
Bamboo Handle, Galvanized	170		Tray	
Bamboo Handle, Stainless Steel	169		Compartment	336
Noodle Skimmer	170		Drip Tray	330
Small Skimmers, Shabu Shabu	170		Fast Food	335
Slicer, Egg	253		Fruit Tray, Polycarbonate	206
Snail			Obon Serving	181
Dish	345		Pastry	335
Fork	345		Pizza Tray, Coupe, Aluminum	199
Tong	345		Pizza Tray, Wide Rim, Aluminum	199
Spade, Ice Cream	279		Round, Stainless Steel	230
Spatula	297		Serving Fiberglass	221
Spoon			Serving Slip Resistant	220
Bamboo Spoon	180		Tip	326
Bar, Deluxe	211		Truck	
Basting	287		Sheet Pan, Aluminum	191
Buffet	290		Turner	296
Curved Basting	286			
Grapefruit	345		<b>W</b> Warmer	
Luxor, Stainless Steel	228		Butter	328
Multi-Purpose	285		Food	260
Perforated	289, 290		Rice, Electric	263
Rice, Plastic	185		Soup, Electric	260, 261
Serving	289, 290		Tortilla	337
Vegetable	285		Whip	
Wooden	168		Dome	302
Spreader	297		French	302
Squeezer, Hand Held			Piano	302
Lemon	209		Tear Drop	302
Lime	209		Wok	
Orange	209		Chafing, Set	184
Stand			Curved Rim	174
Cake	230		Japanese Jin-Ping	175
Pizza	327		Non-Stick Wood Handle	175
Tray	357		San Bai Wok	176
Wire	223		Stainless Wok And Cover	174
Steak Weight	295		Taiwan	175
Steamer, Aluminum	177		Wood	
Stove			Boat	182
Fast Stove	179		Bridge	182
Propane	265		Work Table	366, 367
Induction	261			
Strainer				
Bar	211			
Floor	273			
Julep	211			
Mesh	302, 303			
Sink	275			

## MELAMINE DINNERWARE

Melamine is a non-toxic material, which can be designed accordingly for a variety of Foodservice uses - Healthcare, Cruise Lines, Educational & Correctional Institutions, Buffets, Restaurants and Casinos.



This durable, break-resistant, non-toxic dinnerware can withstand temperatures from 32°F to 212°F (0°C to 100°C).

It is not recommended for microwave use, but is dishwasher safe. (Recommended for low temperature setting & top rack load only)

Our Melamine Dinnerware lines include a wide variety of shapes, sizes, colors, and designs - geared towards meeting the diverse needs and styles of our customers. All of our melamine products meet NSF (National Sanitary Foundation) standards and are safe to use by all commercial Food Service operations. In addition, since Thunder Group manufactures these products, we also have the capability for private label or proprietary products to fit your customer's needs.





## Collection Index

# Melamine

Classic Black	10
Classic Red	14
Classic White	18
Arcadia	22
San Marino	25
Color Green	28
Color Ivory	32
Color Orange	36
Color Pure Red	40
Color Purple	44
Color White	48
Color Yellow	52
Nustone Tan	56
Nustone White	60
Graham	64
Jazz	69
Black Pearl	74
Gold Pearl	78
Serving Boards	81
Passion Pearl	83
Passion Red	86
Passion White	89
Blue Dragon	92
Imperial	98
Longevity	103
Lotus	109
Peacock	115
Rose	121
Blue Bamboo	127
Gold Orchid	135
Tenmoku	140
Two Tone	145
Urushi Spray	147
Wei	149
Blue Jade	156
Ramekin	159
Serving Utencils	164
Gastronorm Pans	166



# Classic Black

MELAMINE



Square Plates • Cascade Bowl  
Square Salad Bowl • Square  
Bowl • Twin Sauce Dish





Item	Description	U/M	Weight Gross lbs	Inner Pack	Master Pack	Cu. Ft.
29004BK	4½" x 4½" x ½", Square Plate	Dozen	7.96	1	4	0.24
29006BK	6" x 6" x ½", Square Plate	Dozen	16.42	1	4	0.55
29007BK	7¼" x 7¼" x ½", Square Plate	Dozen	13.80	1	2	0.45
29009BK	9" x 9" x 1", Square Plate	Dozen	33.10	1	2	0.99
29010BK	10" x 10" x 1", Square Plate	Dozen	44.07	1	2	1.24
29012BK	12" x 12" x 1", Square Plate	Dozen	35.98	1	1	0.90

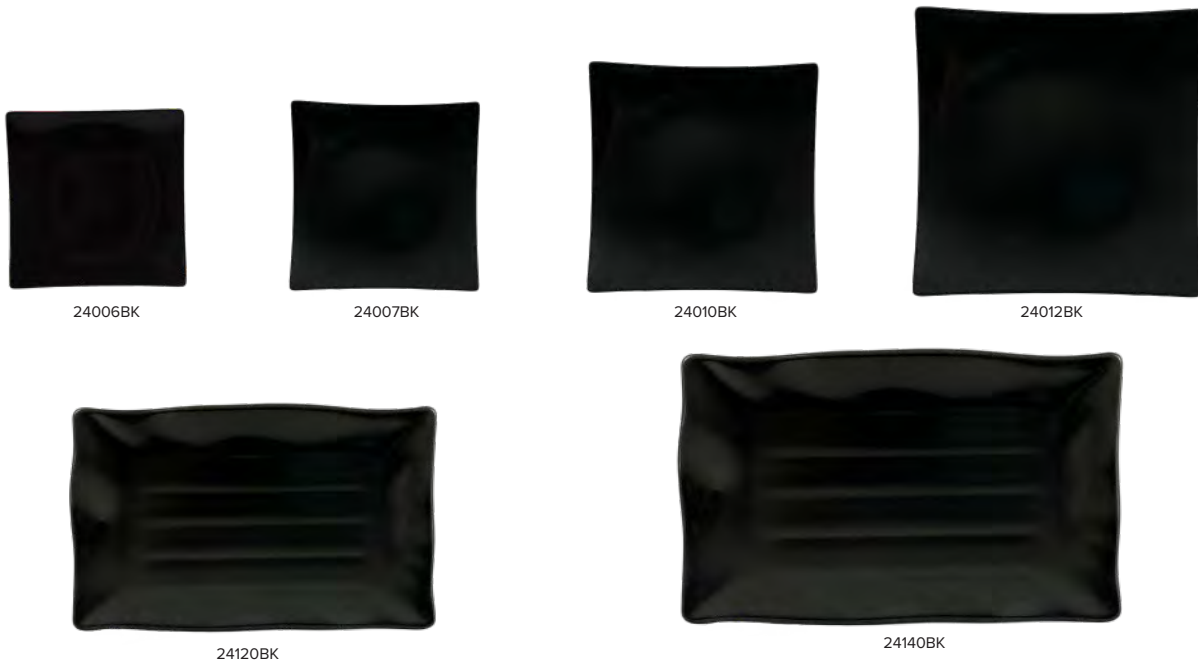

Item	Description	U/M	Weight Gross lbs	Inner Pack	Master Pack	Cu. Ft.
24006BK	6" x 6" x 1", Flare Plate	Dozen	16.42	1	4	0.67
24007BK	7¾" x 7¾" x 1¾", Flare Plate	Dozen	17.24	1	2	0.57
24010BK	10" x 10" x 1¾", Flare Plate	Dozen	38.87	1	2	1.23
24012BK	12¾" x 12¾" x 2", Flare Plate	Dozen	33.09	1	1	1.02
24120BK	11¼" x 7¼" x 1", Wavy Rectangular Plate	Dozen	25.77	1	3	1.41
24140BK	13½" x 9¾" x 1¾", Wavy Rectangular Plate	Dozen	39.20	1	3	2.20

# Classic Black

MELAMINE



39093BK



69003BK



69004BK



69005BK



69007BK



69008BK



69009BK

Item	Description	U/M	Weight Gross lbs	Inner Pack	Master Pack	Cu. Ft.
39093BK	45 oz, 9" Diameter x 3" Deep, Wavy Soup Bowl	Dozen	55.89	1	4	2.33
69003BK	2½ oz, 2½" x 2½" x 1¾", Square Bowl	Dozen	13.21	1	8	0.94
69004BK	8 oz, 3¾" x 3¾" x 1¾", Square Bowl	Dozen	24.22	1	8	0.64
69005BK	22 oz, 5½" x 5½" x 2¼", Square Bowl	Dozen	35.22	1	6	1.10
69007BK	40 oz, 7½" x 7½" x 2¾", Square Bowl	Dozen	53.85	1	4	1.56
69008BK	60 oz, 8" x 8" x 3¼", Square Bowl	Dozen	34.01	1	2	1.10
69009BK	90 oz, 9" x 9" x 3½", Square Bowl	Dozen	48.25	1	2	1.02



CR804BK



CR805BK



CR806BK



CR807BK



39045BK



39050BK



39055BK

Item	Description	U/M	Weight Gross lbs	Inner Pack	Master Pack	Cu. Ft.
CR804BK	12 oz, 6½" Diameter x 1⅞" Low Side Height (3¼" High Side Height), Cascade Bowl	Dozen	42.95	1	6	1.78
CR805BK	16 oz, 8⅞" Diameter x 2¼" Low Side Height (4⅞" High Side Height), Cascade Bowl	Dozen	23.81	1	2	1.02
CR806BK	24 oz, 9¼" Diameter x 2¾" Low Side Height (5" High Side Height), Cascade Bowl	Dozen	31.88	1	2	1.52
CR807BK	35 oz, 10¼" Diameter x 2⅞" Low Side Height (5½" High Side Height), Cascade Bowl	Dozen	37.31	1	2	1.92
39045BK	11 oz, 4½" Diameter x 2¼" Height, Bowl	Dozen	19.75	1	4	1.04
39050BK	16 oz, 5⅞" Diameter x 2⅝" Height, Bowl	Dozen	20.11	1	4	1.08
39055BK	19 oz, 5⅝" Diameter x 2½" Height, Bowl	Dozen	30.31	1	4	1.50



# Classic Black

2023



47128BK



49095BK



49136BK



49168BK



49208BK



19035BK



19045BK



19055BK

Item	Description	U/M	Weight Gross lbs	Inner Pack	Master Pack	Cu. Ft.
47128BK	12½" x 8" x 1⅛", Rectangle Tray	Dozen	41.15	1	2	0.93
49095BK	9½" x 5¼" x ¾", Rectangle Tray	Dozen	28.02	1	4	0.69
49136BK	13" x 6½" x 1", Rectangle Tray	Dozen	38.32	1	3	1.01
49168BK	16⅞" x 8" x 1⅛", Rectangle Tray	Dozen	44.00	1	2	1.19
49208BK	20" x 8" x 1⅜", Rectangle Tray	Dozen	35.49	1	1	0.65
19035BK	2 oz, 3½" Diameter x ¾" Deep, Round Saucer	Dozen	18.52	1	12	0.65
19045BK	4 oz, 4½" Diameter x 1" Deep, Round Saucer	Dozen	16.95	1	6	0.68
19055BK	8 oz, 5½" Diameter x 1¼" Deep, Round Saucer	Dozen	24.40	1	6	0.97



29110BK



29115BK



24110BK



19001BK



19002BK



7200BK



62008BK



63010BK

Item	Description	U/M	Weight Gross lbs	Inner Pack	Master Pack	Cu. Ft.
29110BK	10¼" x 4" x 1", Rectangular Appetizer Tray	Dozen	19.97	1	2	0.61
29115BK	15" x 5¼" x 1", Rectangular Appetizer Tray	Dozen	52.98	1	3	1.55
24110BK	11¼" x 5" x 1", Rectangular Plate	Dozen	33.84	1	3	1.01
19001BK	2 oz, 3¾" x 2½", Sauce Dish	Dozen	17.97	1	12	0.64
19002BK	4 oz, 6" x 3", Twin Sauce Dish	Dozen	29.61	1	12	1.27
7200BK	0.6 oz, 6⅜" x 1¾", Soup Spoon	Dozen	37.93	5	60	1.74
62008BK	28 oz, 8½" x 8½" x 1⅝", Square Salad Bowl	Dozen	30.20	1	2	0.82
63010BK	22 oz, 10½" x 10½" x 1⅜", Pasta Bowl	Dozen	37.08	1	2	1.18

**\*\*Soup Spoon is not NSF Certified.\*\***

MELAMINE

# Classic Red

MELAMINE



Square Plates • Soup Spoon •  
Bowl • Pasta Bowl • Soup Bowl





Item	Description	U/M	Weight Gross lbs	Inner Pack	Master Pack	Cu. Ft.
29004PR	4½" x 4½" x ½", Square Plate	Dozen	7.96	1	4	0.24
29006PR	6" x 6" x ½", Square Plate	Dozen	16.42	1	4	0.55
29007PR	7¼" x 7¼" x ½", Square Plate	Dozen	13.80	1	2	0.45
29009PR	9" x 9" x 1", Square Plate	Dozen	33.10	1	2	0.99
29010PR	10" x 10" x 1", Square Plate	Dozen	44.07	1	2	1.24
29012PR	12" x 12" x 1", Square Plate	Dozen	35.98	1	1	0.90

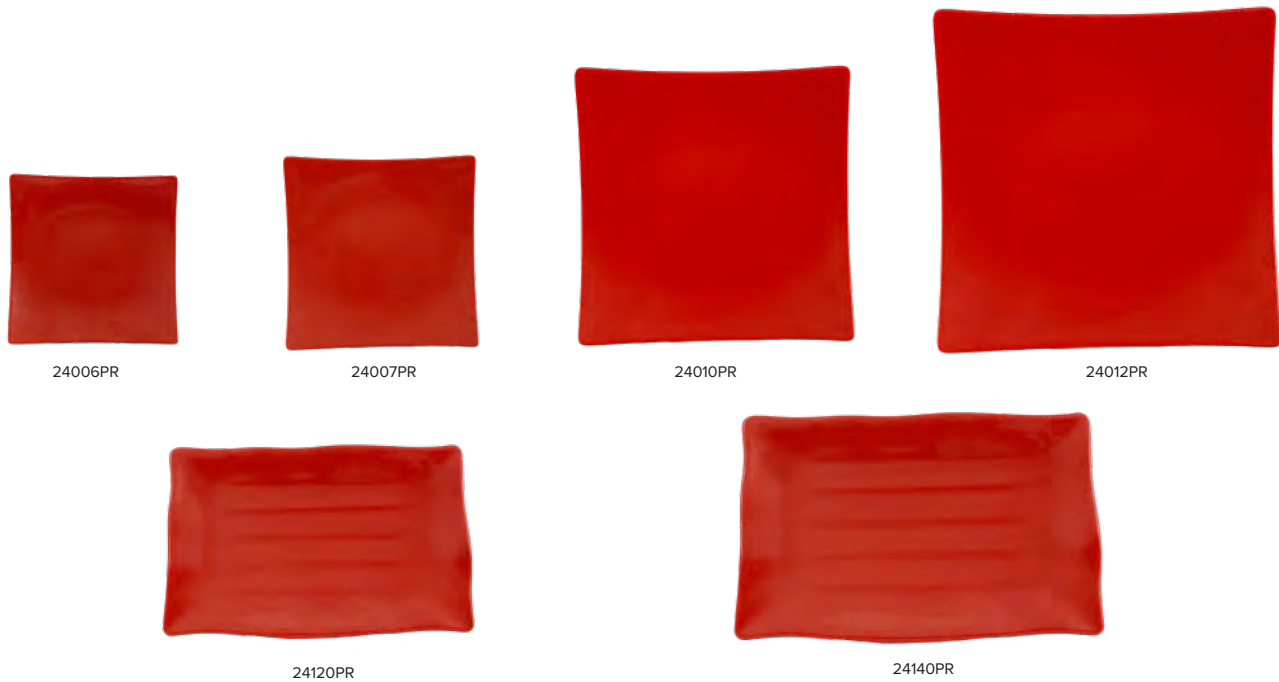

Item	Description	U/M	Weight Gross lbs	Inner Pack	Master Pack	Cu. Ft.
24006PR	6" x 6" x 1", Flare Plate	Dozen	16.42	1	4	0.67
24007PR	7¾" x 7¾" x 1⅜", Flare Plate	Dozen	17.24	1	2	0.57
24010PR	10" x 10" x 1¾", Flare Plate	Dozen	38.87	1	2	1.23
24012PR	12¾" x 12¾" x 2", Flare Plate	Dozen	33.09	1	1	1.02
24120PR	11¼" x 7¼" x 1", Wavy Rectangular Plate	Dozen	25.77	1	3	1.41
24140PR	13½" x 9⅝" x 1⅜", Wavy Rectangular Plate	Dozen	39.20	1	3	2.20

# Classic Red

MELAMINE



47128PR



49095PR



49136PR



49168PR



49208PR

Item	Description	U/M	Weight Gross lbs	Inner Pack	Master Pack	Cu. Ft.
47128PR	12½" x 8" x 1⅛", Rectangle Tray	Dozen	41.15	1	2	0.93
49095PR	9½" x 5 ¼" x ¾", Rectangle Tray	Dozen	28.02	1	4	0.69
49136PR	13" x 6½" x 1", Rectangle Tray	Dozen	38.32	1	3	1.01
49168PR	16⅞" x 8" x 1⅛", Rectangle Tray	Dozen	44.00	1	2	1.19
49208PR	20" x 8" x 1⅜", Rectangle Tray	Dozen	35.49	1	1	0.65



29110PR



29115PR



24110PR

Item	Description	U/M	Weight Gross lbs	Inner Pack	Master Pack	Cu. Ft.
29110PR	10¼" x 4" x 1", Rectangular Appetizer Tray	Dozen	19.97	1	2	0.61
29115PR	15" x 5¼" x 1", Rectangular Appetizer Tray	Dozen	52.98	1	3	1.55
24110PR	11¼" x 5" x 1", Rectangular Plate	Dozen	33.84	1	3	1.01





69003PR



69004PR



69005PR



69007PR



69008PR



69009PR

Item	Description	U/M	Weight Gross lbs	Inner Pack	Master Pack	Cu. Ft.
69003PR	2½ oz, 2⅝" x 2⅝" x 1 ⅞", Square Bowl	Dozen	13.21	1	8	0.94
69004PR	8 oz, 3⅞" x 3⅞" x 1¾", Square Bowl	Dozen	24.22	1	8	0.64
69005PR	22 oz, 5½" x 5½" x 2¼", Square Bowl	Dozen	35.22	1	6	1.10
69007PR	40 oz, 7⅞" x 7⅞" x 2 ¾", Square Bowl	Dozen	53.85	1	4	1.56
69008PR	60 oz, 8" x 8" x 3¼", Square Bowl	Dozen	34.01	1	2	1.10
69009PR	90 oz, 9" x 9" x 3⅝", Square Bowl	Dozen	48.25	1	2	1.02



62008PR



63010PR



39093PR



39045PR



39050PR



39055PR



7200PR

Item	Description	U/M	Weight Gross lbs	Inner Pack	Master Pack	Cu. Ft.
62008PR	28 oz, 8½" x 8½" x 1⅝", Square Salad Bowl	Dozen	30.20	1	2	0.82
63010PR	22 oz, 10½" x 10½" x 1⅜", Pasta Bowl	Dozen	37.08	1	2	1.18
39093PR	45 oz, 9" Diameter x 3" Deep, Wavy Soup Bowl	Dozen	55.89	1	4	2.33
39045PR	11 oz, 4½" Diameter x 2¼" Height, Bowl	Dozen	19.75	1	4	1.04
39050PR	16 oz, 5⅞" Diameter x 2⅝" Height, Bowl	Dozen	20.11	1	4	1.08
39055PR	19 oz, 5⅝" Diameter x 2½" Height, Bowl	Dozen	30.31	1	4	1.50
7200PR	0.6 oz, 6⅜" x 1¾", Soup Spoon	Dozen	37.93	5	60	1.74

**\*\*Soup Spoon is not NSF Certified.\*\***

# Classic White

MELAMINE



Pasta Bowl • Soup Spoon •  
Cascading Bowl • Square Bowls  
• Square Plates





Item	Description	U/M	Weight Gross lbs	Inner Pack	Master Pack	Cu. Ft.
29004WT	4½" x 4½" x ½", Square Plate	Dozen	7.96	1	4	0.24
29006WT	6" x 6" x ½", Square Plate	Dozen	16.42	1	4	0.55
29007WT	7¼" x 7¼" x ½", Square Plate	Dozen	13.80	1	2	0.45
29009WT	9" x 9" x 1", Square Plate	Dozen	33.10	1	2	0.99
29010WT	10" x 10" x 1", Square Plate	Dozen	44.07	1	2	1.24
29012WT	12" x 12" x 1", Square Plate	Dozen	35.98	1	1	0.90

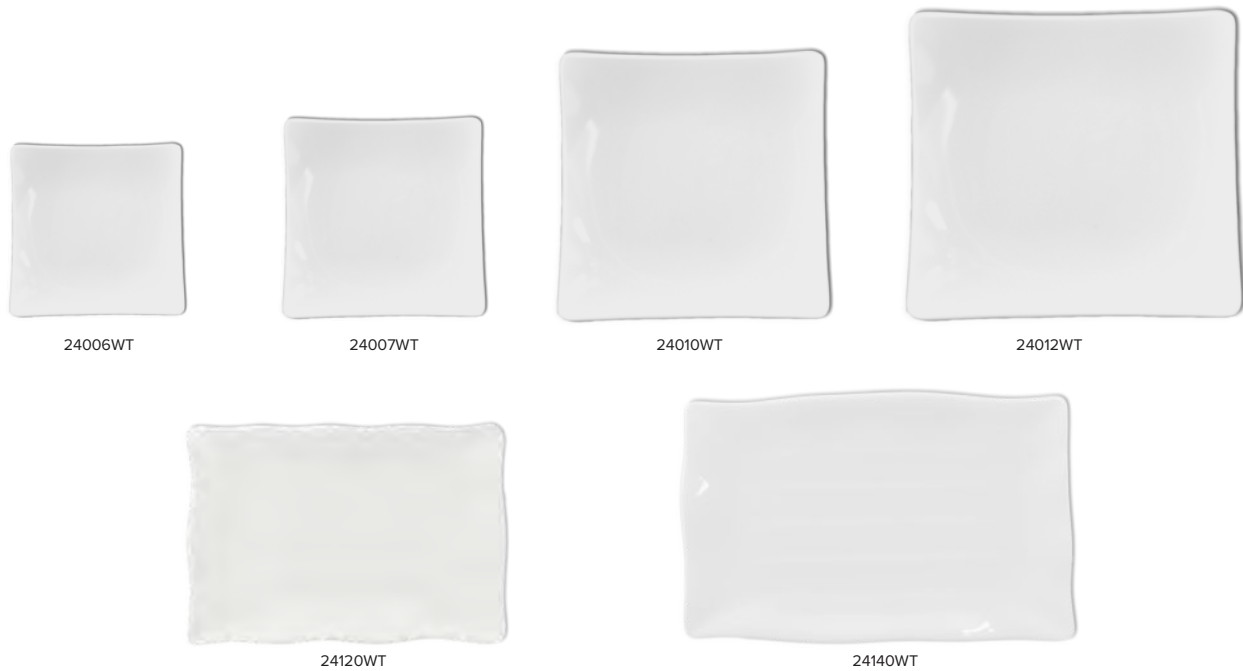

Item	Description	U/M	Weight Gross lbs	Inner Pack	Master Pack	Cu. Ft.
24006WT	6" x 6" x 1", Flare Plate	Dozen	16.42	1	4	0.67
24007WT	7¾" x 7¾" x 1⅜", Flare Plate	Dozen	17.24	1	2	0.57
24010WT	10" x 10" x 1⅜", Flare Plate	Dozen	38.87	1	2	1.23
24012WT	12¾" x 12¾" x 2", Flare Plate	Dozen	33.09	1	1	1.02
24120WT	11¼" x 7¼" x 1", Wavy Rectangular Plate	Dozen	25.77	1	3	1.41
24140WT	13½" x 9⅝" x 1⅜", Wavy Rectangular Plate	Dozen	39.20	1	3	2.20

# Classic White

MELAMINE



39093WT



69003WT



69004WT



69005WT



69007WT



69008WT



69009WT

Item	Description	U/M	Weight Gross lbs	Inner Pack	Master Pack	Cu. Ft.
39093WT	45 oz, 9" Diameter x 3" Deep, Wavy Soup Bowl	Dozen	55.89	1	4	2.33
69003WT	2½ oz, 2⅝" x 2⅝" x 1⅜", Square Bowl	Dozen	13.21	1	8	0.94
69004WT	8 oz, 3⅞" x 3⅞" x 1¾", Square Bowl	Dozen	24.22	1	8	0.64
69005WT	22 oz, 5½" x 5½" x 2¼", Square Bowl	Dozen	35.22	1	6	1.10
69007WT	40 oz, 7⅞" x 7⅞" x 2¾", Square Bowl	Dozen	53.85	1	4	1.56
69008WT	60 oz, 8" x 8" x 3¼", Square Bowl	Dozen	33.92	1	2	1.03
69009WT	90 oz, 9" x 9" x 3⅝", Square Bowl	Dozen	48.25	1	2	1.02



CR804W



CR805W



CR806W



CR807W



39045WT



39050WT



39055WT

Item	Description	U/M	Weight Gross lbs	Inner Pack	Master Pack	Cu. Ft.
CR804W	12 oz, 6½" Diameter x 1⅞" Low Side Height (3¼" High Side Height), Cascade Bowl	Dozen	42.95	1	6	1.78
CR805W	16 oz, 8⅞" Diameter x 2¼" Low Side Height (4⅞" High Side Height), Cascade Bowl	Dozen	23.81	1	2	1.02
CR806W	24 oz, 9¼" Diameter x 2¾" Low Side Height (5" High Side Height), Cascade Bowl	Dozen	31.88	1	2	1.52
CR807W	35 oz, 10¼" Diameter x 2⅞" Low Side Height (5½" High Side Height), Cascade Bowl	Dozen	37.31	1	2	1.92
39045WT	11 oz, 4½" Diameter x 2¼" Height, Bowl	Dozen	19.75	1	4	1.04
39050WT	16 oz, 5 ⅛" Diameter x 2⅝" Height, Bowl	Dozen	20.11	1	4	1.08
39055WT	19 oz, 5⅝" Diameter x 2½" Height, Bowl	Dozen	30.31	1	4	1.50





47128WT



49095WT



49136WT



49168WT



49208WT



19035WT



19045WT



19055WT

Item	Description	U/M	Weight Gross lbs	Inner Pack	Master Pack	Cu. Ft.
47128WT	12½" x 8" x 1½", Rectangle Tray	Dozen	41.15	1	2	0.93
49095WT	9½" x 5¼" x ¾", Rectangle Tray	Dozen	28.02	1	4	0.69
49136WT	13" x 6½" x 1", Rectangle Tray	Dozen	38.32	1	3	1.01
49168WT	16½" x 8" x 1½", Rectangle Tray	Dozen	44.00	1	2	1.19
49208WT	20" x 8" x 1¾", Rectangle Tray	Dozen	35.49	1	1	0.65
19035WT	2 oz, 3½" Diameter x ¾" Deep, Round Saucer	Dozen	18.52	1	12	0.65
19045WT	4 oz, 4½" Diameter x 1" Deep, Round Saucer	Dozen	16.95	1	6	0.68
19055WT	8 oz, 5½" Diameter x 1¼" Deep, Round Saucer	Dozen	24.40	1	6	0.97



29110WT



29115WT



24110WT



19001WT



19002WT



7200WT



62008WT



63010WT

Item	Description	U/M	Weight Gross lbs	Inner Pack	Master Pack	Cu. Ft.
29110WT	10¼" x 4" x 1", Rectangular Appetizer Tray	Dozen	19.97	1	2	0.61
29115WT	15" x 5¼" x 1", Rectangular Appetizer Tray	Dozen	52.98	1	3	1.55
24110WT	11 ¼" x 5" x 1", Rectangular Plate	Dozen	33.84	1	3	1.01
19001WT	2 oz, 3¾" x 2½", Sauce Dish	Dozen	17.97	1	12	0.64
19002WT	4 oz, 6" x 3", Twin Sauce Dish	Dozen	29.61	1	12	1.27
7200WT	0.6 oz, 6¾" x 1¾", Soup Spoon	Dozen	37.93	5	60	1.74
62008WT	28 oz, 8½" x 8½" x 1½", Square Salad Bowl	Dozen	30.20	1	2	0.82
63010WT	22 oz, 10½" x 10½" x 1¾", Pasta Bowl	Dozen	37.08	1	2	1.18

**\*\*Soup Spoon is not NSF Certified.\*\***

# Arcadia

MELAMINE



Platter • Dinner Plate • Bouillon  
Cup • Soup Bowl • Fruit Bowl





AD209AA



AD211AA



AD212AA



AD214AA

Item	Description	U/M	Weight Gross lbs	Inner Pack	Master Pack	Cu. Ft.
AD209AA	9½" x 7¼" x ¾", Platter	Dozen	40.92	1	6	1.26
AD211AA	11½" x 8" x ¾", Platter	Dozen	36.71	1	4	1.14
AD212AA	12" x 9" x 1", Platter	Dozen	32.52	1	3	1.15
AD214AA	14" x 10" x ¾", Platter	Dozen	24.25	0.50	2	1.04



AD216AA



AD221AA



AD222AA

Item	Description	U/M	Weight Gross lbs	Inner Pack	Master Pack	Cu. Ft.
AD216AA	16 ¼" x 12" x 1 ⅜", Platter	Dozen	33.44	0.50	2	1.71
AD221AA	14 oz, 11 ½" x 8" x 1", Platter	Dozen	35.54	1	4	1.14
AD222AA	24 oz, 12" x 9" x 1 ⅜", Platter	Dozen	36.55	1	3	1.27

# Arcadia



AD106AA



AD107AA



AD109AA



AD110AA

Item	Description	U/M	Weight Gross lbs	Inner Pack	Master Pack	Cu. Ft.
AD106AA	6¼" Diameter x ¾" Height, Bread Plate	Dozen	22.53	1	6	0.78
AD107AA	7½" Diameter x ¾" Height, Dinner Plate	Dozen	33.73	1	8	1.17
AD109AA	9" Diameter x ¾" Height, Dinner Plate	Dozen	37.81	1	6	1.35
AD110AA	10" Diameter x ⅞" Height, Dinner Plate	Dozen	37.43	1	4	1.25



AD305AA



AD306AA



AD307AA



AD507AA

Item	Description	U/M	Weight Gross lbs	Inner Pack	Master Pack	Cu. Ft.
AD305AA	4 oz, 5 ¼" Diameter x 1" Height, Fruit Bowl	Dozen	42.55	1	16	1.31
AD306AA	10 oz, 6¼" Diameter x 1½" Height, Salad Bowl	Dozen	33.14	1	8	1.11
AD307AA	17 oz, 7¼" Diameter x 1⅝" Height, Salad Bowl	Dozen	40.81	1	8	1.63
AD507AA	32 oz, 7½" Diameter x 2½" Height, Rim Soup Bowl	Dozen	45.11	1	8	2.35



AD918AA



AD302AA



AD908AA

Item	Description	U/M	Weight Gross lbs	Inner Pack	Master Pack	Cu. Ft.
AD918AA	9 oz, 3¼" Diameter x 3¾" Height, Round Base Cup, Two Tone	Dozen	23.04	1	5	1.55
AD302AA	7 oz, 4" Diameter x 2⅞" Height, Bouillon Cup	Dozen	26.08	1	10	1.00
AD908AA	9 oz, 3" Diameter x 3¾" Height, Cup, Two Tone	Dozen	23.56	1	5	1.63



# San Marino



Platter • Dinner Plate • Bowl •  
Fruit Bowl • Bread Plate • Cup



# San Marino



AD209WS



AD211WS



AD212WS



AD214WS



AD216WS

Item	Description	U/M	Weight Gross lbs	Inner Pack	Master Pack	Cu. Ft.
AD209WS	9½" x 7¼" x ¾", Platter	Dozen	40.92	1	6	1.26
AD211WS	11½" x 8" x ¾", Platter	Dozen	36.71	1	4	1.14
AD212WS	12" x 9" x 1", Platter	Dozen	32.52	1	3	1.15
AD214WS	14" x 10" x ⅞", Platter	Dozen	24.25	0.50	2	1.04
AD216WS	16¼" x 12" x 1⅜", Platter	Dozen	33.44	0.50	2	1.71



AD221WS



AD222WS

Item	Description	U/M	Weight Gross lbs	Inner Pack	Master Pack	Cu. Ft.
AD221WS	14 oz, 11½" x 8" x 1", Platter	Dozen	35.54	1	4	1.14
AD222WS	24 oz, 12" x 9" x 1⅜", Platter	Dozen	36.55	1	3	1.27



AD106WS



AD107WS



AD109WS



AD110WS

Item	Description	U/M	Weight Gross lbs	Inner Pack	Master Pack	Cu. Ft.
AD106WS	6¼" Diameter x ¾" Height, Dinner Plate	Dozen	22.53	1	6	0.78
AD107WS	7½" Diameter x ¾" Height, Dinner Plate	Dozen	33.73	1	8	1.17
AD109WS	9" Diameter x ¾" Height, Dinner Plate	Dozen	37.81	1	6	1.35
AD110WS	10" Diameter x ⅞" Height, Dinner Plate	Dozen	37.43	1	4	1.25





AD507WS



AD314WS



AD304WS



AD305WS



AD306WS



AD307WS

Item	Description	U/M	Weight Gross lbs	Inner Pack	Master Pack	Cu. Ft.
AD507WS	32 oz, 7½" Diameter x 2½" Deep, Rim Soup Bowl	Dozen	45.11	1	8	2.35
AD314WS	11 oz, 4⅞" Diameter x 1¾" Height, Nappie	Dozen	24.20	1	8	1.13
AD304WS	8 oz, 4 ¼" Diameter x 2¼" Height, Bouillon Cup	Dozen	27.65	1	8	1.10
AD305WS	4 oz, 5 ¼" Diameter x 1" Height, Fruit Bowl	Dozen	42.55	1	16	1.31
AD306WS	10 oz, 6¼" Diameter x 1½" Height, Salad Bowl	Dozen	33.14	1	8	1.11
AD307WS	17 oz, 7¼" Diameter x 1⅝" Height, Salad Bowl	Dozen	40.81	1	8	1.63



AD9016WS



AD302WS



AD313WS



AD908WS



AD918WS

Item	Description	U/M	Weight Gross lbs	Inner Pack	Master Pack	Cu. Ft.
AD9016WS	10 oz, 4" Diameter x 3½" Height, Soup Mug	Dozen	29.50	1	5	1.74
AD302WS	7 oz, 4" Diameter x 2⅞" Height, Bouillon Cup	Dozen	26.08	1	10	1.00
AD313WS	5 oz, 3¾" Diameter x 2¼" Height, Dessert Dish	Dozen	11.90	1	8	0.73
AD908WS	9 oz, 3" Diameter x 3¾" Height, Cup	Dozen	23.56	1	5	1.63
AD918WS	9 oz, 3 ¼" Diameter x 3¾" Height, Round Base Cup	Dozen	23.04	1	5	1.55

# Color Green

MELAMINE



Pasta Bowl • Narrow Rim Plate  
• Soup Spoon • Cup • Saucer •  
Soup Bowl





CR005GR



CR006GR



CR007GR



CR009GR



CR010GR



CR012GR



CR710GR

Item	Description	U/M	Weight Gross lbs	Inner Pack	Master Pack	Cu. Ft.
CR005GR	5½" Diameter x ¾" Height, Wide Rim Plate	Dozen	28.13	1	8	0.96
CR006GR	6½" Diameter x ¾" Height, Wide Rim Plate	Dozen	37.83	1	8	1.24
CR007GR	7½" Diameter x ¾" Height, Wide Rim Plate	Dozen	37.41	1	6	1.31
CR009GR	9 ¼" Diameter x 7⁄8" Height, Wide Rim Plate	Dozen	36.55	1	4	1.17
CR010GR	10 ½" Diameter x 7⁄8" Height, Wide Rim Plate	Dozen	46.72	1	4	1.56
CR012GR	11¾" Diameter x 1" Height, Wide Rim Plate	Dozen	48.90	1	4	1.90
CR710GR	10¼" Diameter x 1" Height, 3-Section Compartment Plate	Dozen	21.34	1	2	0.71



CR209GR



CR212GR



CR213GR

Item	Description	U/M	Weight Gross lbs	Inner Pack	Master Pack	Cu. Ft.
CR209GR	9½" x 7¼" x ¾", Platter	Dozen	27.56	1	4	0.87
CR212GR	12" x 9" x ¾", Platter	Dozen	44.48	1	4	1.53
CR213GR	13½" x 10½" x 1", Platter	Dozen	42.35	0.50	3	1.57

# Color Green

MELAMINE



CR106GR



CR107GR



CR109GR



CR110GR

Item	Description	U/M	Weight Gross lbs	Inner Pack	Master Pack	Cu. Ft.
CR106GR	6½" Diameter x ¾" Height, Narrow Rim Plate	Dozen	36.42	1	8	1.31
CR107GR	7¼" Diameter x ⅝" Height, Narrow Rim Plate	Dozen	32.54	1	6	1.07
CR109GR	9" Diameter x ⅞" Height, Narrow Rim Plate	Dozen	35.47	1	4	1.33
CR110GR	10½" Diameter x ¾" Height, Narrow Rim Plate	Dozen	41.78	1	4	1.45



CR5077GR



CR5716GR



CR5809GR



CR5810GR



CR5811GR



CR5608GR

Item	Description	U/M	Weight Gross lbs	Inner Pack	Master Pack	Cu. Ft.
CR5077GR	8 oz, 7¾" Diameter x 1½" Height, Wide Rim Salad Bowl	Dozen	48.57	1	8	1.93
CR5716GR	18 oz, 7½" Diameter x 1¾" Height, Soup Bowl	Dozen	40.45	1	6	1.56
CR5809GR	13 oz, 9¼" Diameter x 1⅜" Height, Salad Bowl	Dozen	39.64	1	4	1.42
CR5810GR	12 oz, 10¼" Diameter x 1½" Height, Pasta Bowl	Dozen	39.95	1	3	1.34
CR5811GR	16 oz, 11¼" Diameter x 1⅝" Height, Pasta Bowl	Dozen	42.13	0.50	3	2.12
CR5608GR	8 oz, 6" Diameter x 1½" Height, Salad Bowl	Dozen	41.01	1	8	1.26



CR5807GR



CR5804GR



CR5712GR



CR9016GR



CR5510GR



CR305GR



7000G

Item	Description	U/M	Weight Gross lbs	Inner Pack	Master Pack	Cu. Ft.
CR5807GR	32 oz, 7½" Diameter x 2⅝" Height, Salad Bowl	Dozen	31.75	1	4	1.35
CR5804GR	10 oz, 4⅝" Diameter x 2¼" Height, Soup Bowl	Dozen	31.75	1	6	1.43
CR5712GR	15 oz, 7¼" Diameter x 1⅞" Height, Soup Bowl	Dozen	45.55	1	6	1.57
CR9016GR	10 oz, 4" Diameter x 2⅜" Height, Soup Mug	Dozen	29.50	1	5	1.76
CR5510GR	10 oz, 5 ½" Diameter x 2½" Height, Soup Bowl	Dozen	40.76	1	8	1.67
CR305GR	10 oz, 4⅝" Diameter x 2" Height, Soup Bowl with 2½" Handle	Dozen	18.02	1	4	1.44
7000G	1 oz, 6⅜" x 1⅞", Spoon	Dozen	31.86	5	40	2.00



CR9035GR



CR9010GR



CR9018GR



CR313GR



CR5044GR



CR303GR



CR9303GR



CR9108GR



ML536GR1



ML538GR1

Item	Description	U/M	Weight Gross lbs	Inner Pack	Master Pack	Cu. Ft.
CR9035GR	10 oz, 3⅜" Diameter x 3⅞" Height, Mug	Dozen	32.23	1	5	1.74
CR9010GR	8 oz, 2⅞" Diameter x 3⅞" Height, Mug	Dozen	28.46	1	4	1.36
CR9018GR	7 oz, 3⅞" Diameter x 3⅞" Height, Mug/Cup	Dozen	48.90	1	8	2.39
CR313GR	8 oz, 4 ¼" Diameter x 2⅞" Height, Bouillon Cup	Dozen	27.71	1	8	1.10
CR5044GR	4 oz, 4 ¾" Diameter x 1⅜" Height, Salad Bowl	Dozen	23.10	1	8	0.79
CR303GR	7 oz, 4" Diameter x 2⅞" Height, Bouillon Cup	Dozen	26.68	1	8	1.19
CR9303GR	5½" Diameter x ⅝" Height, Saucer For CR303/CR9018	Dozen	37.46	1	10	1.43
CR9108GR	5½" Diameter x ¾" Height, Saucer For CR313/CR5044	Dozen	37.70	1	10	1.34
ML536GR1	2½ oz, 2⅞" Diameter x 1¾" Height, Smooth Ramekin	Dozen	48.05	1	48	2.05
ML538GR1	4 oz, 3⅜" Diameter x 1¾" Height, Smooth Ramekin	Dozen	50.71	1	24	2.49

**\*\*Soup Spoon is not NSF Certified.\*\***

# Color Ivory

MELAMINE



Compartment Plate • Wide Rim  
Plate • Soup Bowl • Bouillon Cup  
• Mug • Soup Spoon







CR005V



CR006V



CR007V



CR009V



CR010V



CR012V



CR710V

Item	Description	U/M	Weight Gross lbs	Inner Pack	Master Pack	Cu. Ft.
CR005V	5½" Diameter x ¾" Height, Wide Rim Plate	Dozen	28.13	1	8	0.96
CR006V	6½" Diameter x ¾" Height, Wide Rim Plate	Dozen	37.83	1	8	1.24
CR007V	7⅝" Diameter x ¾" Height, Wide Rim Plate	Dozen	37.41	1	6	1.31
CR009V	9¼" Diameter x ⅞" Height, Wide Rim Plate	Dozen	36.55	1	4	1.17
CR010V	10½" Diameter x ⅞" Height, Wide Rim Plate	Dozen	46.72	1	4	1.56
CR012V	11¾" Diameter x 1" Height, Wide Rim Plate	Dozen	48.90	1	4	1.90
CR710V	10¼" Diameter x 1" Height, 3-Section Compartment Plate	Dozen	21.34	1	2	0.71



CR209V



CR212V



CR213V

Item	Description	U/M	Weight Gross lbs	Inner Pack	Master Pack	Cu. Ft.
CR209V	9½" x 7¼" x ¾", Platter	Dozen	27.56	1	4	0.87
CR212V	12" x 9" x ¾", Platter	Dozen	44.48	1	4	1.53
CR213V	13½" x 10½" x 1", Platter	Dozen	42.35	0.50	3	1.57

# Color Ivory



CR106V



CR107V



CR109V



CR110V

Item	Description	U/M	Weight Gross lbs	Inner Pack	Master Pack	Cu. Ft.
CR106V	6½" Diameter x ¾" Height, Narrow Rim Plate	Dozen	36.42	1	8	1.31
CR107V	7¼" Diameter x ⅝" Height, Narrow Rim Plate	Dozen	32.54	1	6	1.07
CR109V	9" Diameter x ⅞" Height, Narrow Rim Plate	Dozen	35.47	1	4	1.33
CR110V	10½" Diameter x ¾" Height, Narrow Rim Plate	Dozen	41.78	1	4	1.45



CR5077V



CR5716V



CR5809V



CR5810V



CR5811V



CR5608V

Item	Description	U/M	Weight Gross lbs	Inner Pack	Master Pack	Cu. Ft.
CR5077V	8 oz, 7¾" Diameter x 1½" Height, Wide Rim Salad Bowl	Dozen	48.57	1	8	1.93
CR5716V	18 oz, 7½" Diameter x 1¾" Height, Soup Bowl	Dozen	40.45	1	6	1.56
CR5809V	13 oz, 9¼" Diameter x 1⅜" Height, Salad Bowl	Dozen	39.64	1	4	1.42
CR5810V	12 oz, 10¼" Diameter x 1½" Height, Pasta Bowl	Dozen	39.95	1	3	1.34
CR5811V	16 oz, 11¼" Diameter x 1⅝" Height, Pasta Bowl	Dozen	42.13	0.50	3	2.12
CR5608V	8 oz, 6" Diameter x 1½" Height, Salad Bowl	Dozen	41.01	1	8	1.26



CR5807V



CR5804V



CR5712V



CR9016V



CR5510V



CR305V



7000V

Item	Description	U/M	Weight Gross lbs	Inner Pack	Master Pack	Cu. Ft.
CR5807V	32 oz, 7½" Diameter x 2⅝" Height, Salad Bowl	Dozen	31.75	1	4	1.35
CR5804V	10 oz, 4⅝" Diameter x 2¼" Height, Soup Bowl	Dozen	31.75	1	6	1.43
CR5712V	15 oz, 7¼" Diameter x 1⅞" Height, Soup Bowl	Dozen	45.55	1	6	1.57
CR9016V	10 oz, 4" Diameter x 2⅜" Height, Soup Mug	Dozen	29.50	1	5	1.76
CR5510V	10 oz, 5 ½" Diameter x 2½" Height, Soup Bowl	Dozen	40.76	1	8	1.67
CR305V	10 oz, 4⅝" Diameter x 2" Height, Soup Bowl with 2⅞" Handle	Dozen	18.02	1	4	1.44
7000V	1 oz, 6 ⅜" x 1⅞", Spoon	Dozen	31.86	5	40	2.00



CR9035V



CR9010V



ML9011I



ML901I



CR9018V



CR313V



CR5044V



CR303V



CR9303V



CR9108V

Item	Description	U/M	Weight Gross lbs	Inner Pack	Master Pack	Cu. Ft.
CR9035V	10 oz, 3⅝" Diameter x 3⅞" Height, Mug	Dozen	32.23	1	5	1.74
CR9010V	8 oz, 2⅞" Diameter x 3⅞" Height, Mug	Dozen	28.46	1	4	1.36
ML9011I	7 oz, 3¼" Diameter x 2¾" Height, Stacking Cup	Dozen	16.25	1	5	1.42
ML901I	8 oz, 3" Diameter x 3¾" Height, Bulbous Mug	Dozen	29.59	0.50	5	1.77
CR9018V	7 oz, 3⅝" Diameter x 3⅞" Height, Mug/Cup	Dozen	48.90	1	8	2.39
CR313V	8 oz, 4 ¼" Diameter x 2⅞" Height, Bouillon Cup	Dozen	27.71	1	8	1.10
CR5044V	4 oz, 4 ¾" Diameter x 1⅞" Height, Salad Bowl	Dozen	23.10	1	8	0.79
CR303V	7 oz, 4" Diameter x 2⅞" x Height, Bouillon Cup	Dozen	26.68	1	8	1.19
CR9303V	5½" Diameter x ⅝" Height, Saucer For CR303/CR9018	Dozen	37.46	1	10	1.43
CR9108V	5½" Diameter x ¾" Height, Saucer For CR313/CR5044/ML901/ML9011	Dozen	37.70	1	10	1.34

**\*\*Soup Spoon is not NSF Certified.\*\***

# Color Orange

MELAMINE



Platter • Compartment Plate  
• Soup Bowl • Soup Spoon •  
Bouillon Cups • Mug • Saucer



# Color Orange

2023



CR005RD



CR006RD



CR007RD



CR009RD



CR010RD



CR012RD



CR710RD

Item	Description	U/M	Weight Gross lbs	Inner Pack	Master Pack	Cu. Ft.
CR005RD	5½" Diameter x ¾" Height, Wide Rim Plate	Dozen	28.13	1	8	0.96
CR006RD	6½" Diameter x ¾" Height, Wide Rim Plate	Dozen	37.83	1	8	1.24
CR007RD	7⅝" Diameter x ¾" Height, Wide Rim Plate	Dozen	37.41	1	6	1.31
CR009RD	9¼" Diameter x ⅞" Height, Wide Rim Plate	Dozen	36.55	1	4	1.17
CR010RD	10½" Diameter x ⅞" Height, Wide Rim Plate	Dozen	46.72	1	4	1.56
CR012RD	11¾" Diameter x 1" Height, Wide Rim Plate	Dozen	48.90	1	4	1.90
CR710RD	10¼" Diameter x 1" Height, 3-Section Compartment Plate	Dozen	21.34	1	2	0.71



CR209RD



CR212RD



CR213RD

Item	Description	U/M	Weight Gross lbs	Inner Pack	Master Pack	Cu. Ft.
CR209RD	9½" x 7¼" x ¾", Platter	Dozen	27.56	1	4	0.87
CR212RD	12" x 9" x ¾", Platter	Dozen	44.48	1	4	1.53
CR213RD	13½" x 10½" x 1", Platter	Dozen	42.35	0.50	3	1.57

MELAMINE

# Color Orange



CR106RD



CR107RD



CR109RD



CR110RD

Item	Description	U/M	Weight Gross lbs	Inner Pack	Master Pack	Cu. Ft.
CR106RD	6½" Diameter x ¾" Height, Narrow Rim Plate	Dozen	36.42	1	8	1.31
CR107RD	7¼" Diameter x ⅝" Height, Narrow Rim Plate	Dozen	32.54	1	6	1.07
CR109RD	9" Diameter x ⅞" Height, Narrow Rim Plate	Dozen	35.47	1	4	1.33
CR110RD	10½" Diameter x ¾" Height, Narrow Rim Plate	Dozen	41.78	1	4	1.45



CR5077RD



CR5716RD



CR5809RD



CR5810R



CR5811RD



CR5608RD

Item	Description	U/M	Weight Gross lbs	Inner Pack	Master Pack	Cu. Ft.
CR5077RD	8 oz, 7¾" Diameter x 1½" Height, Wide Rim Salad Bowl	Dozen	48.57	1	8	1.93
CR5716RD	18 oz, 7½" Diameter x 1¾" Height, Soup Bowl	Dozen	40.45	1	6	1.56
CR5809RD	13 oz, 9¼" Diameter x 1⅜" Height, Salad Bowl	Dozen	39.64	1	4	1.42
CR5810R	12 oz, 10¼" Diameter x 1½" Height, Pasta Bowl	Dozen	39.95	1	3	1.34
CR5811RD	16 oz, 11 ¼" Diameter x 1⅝" Height, Pasta Bowl	Dozen	42.13	0.50	3	2.12
CR5608RD	8 oz, 6" Diameter x 1½" Height, Salad Bowl	Dozen	41.01	1	8	1.26



# Color Orange

2023



CR5807RD



CR5804RD



CR5712RD



CR9016RD



CR5510RD



CR305RD



7000R

Item	Description	U/M	Weight Gross lbs	Inner Pack	Master Pack	Cu. Ft.
CR5807RD	32 oz, 7½" Diameter x 2⅝" Height, Salad Bowl	Dozen	31.75	1	4	1.35
CR5804RD	10 oz, 4⅝" Diameter x 2¼" Height, Soup Bowl	Dozen	31.75	1	6	1.43
CR5712RD	15 oz, 7¼" Diameter x 1⅞" Height, Soup Bowl	Dozen	45.55	1	6	1.57
CR9016RD	10 oz, 4" Diameter x 2⅜" Height, Soup Mug	Dozen	29.50	1	5	1.76
CR5510RD	10 oz, 5½" Diameter x 2⅝" Height, Soup Bowl	Dozen	40.76	1	8	1.67
CR305RD	10 oz, 4⅝" Diameter x 2" Height, Soup Bowl with 2½" Handle	Dozen	18.02	1	4	1.44
7000R	1 oz, 6⅜" x 1⅞", Spoon	Dozen	31.86	5	40	2.00

**\*\*Soup Spoon is not NSF Certified.\*\***



CR9035RD



CR9010RD



CR9018RD



CR313RD



CR5044RD



CR303RD



CR9303RD



CR9108RD



ML536RD1



ML538RD1

Item	Description	U/M	Weight Gross lbs	Inner Pack	Master Pack	Cu. Ft.
CR9035RD	10 oz, 3⅝" Diameter x 3⅝" Height, Mug	Dozen	32.23	1	5	1.74
CR9010RD	8 oz, 2⅞" Diameter x 3⅞" Height, Mug	Dozen	28.46	1	4	1.36
CR9018RD	7 oz, 3⅝" Diameter x 3⅞" Height, Mug/Cup	Dozen	48.90	1	8	2.39
CR313RD	8 oz, 4 ¼" Diameter x 2½" Height, Bouillon Cup	Dozen	27.71	1	8	1.10
CR5044RD	4 oz, 4 ¾" Diameter x 1⅝" Height, Salad Bowl	Dozen	23.10	1	8	0.79
CR303RD	7 oz, 4" Diameter x 2½" Height, Bouillon Cup	Dozen	26.68	1	8	1.19
CR9303RD	5½" Diameter x ⅝" Height, Saucer For CR303/CR9018	Dozen	37.46	1	10	1.43
CR9108RD	5½" Diameter x ¾" Height, Saucer For CR313/CR5044	Dozen	37.70	1	10	1.34
ML536RD1	2½ oz, 2⅞" Diameter x 1⅝" Height, Smooth Ramekin	Dozen	48.05	1	48	2.05
ML538RD1	4 oz, 3⅝" Diameter x 1¾" Height, Smooth Ramekin	Dozen	50.71	1	24	2.49

MELAMINE

# *Color Pure Red*

MELAMINE



Wide Rim Plate • Compartment  
Plate • Cascade Bowl • Bouillon  
Cup • Platter • Ramekin





# Color Pure Red

2023



CR005PR



CR006PR



CR007PR



CR009PR



CR010PR



CR012PR



CR710PR

Item	Description	U/M	Weight Gross lbs	Inner Pack	Master Pack	Cu. Ft.
CR005PR	5½" Diameter x ¾" Height, Wide Rim Plate	Dozen	28.13	1	8	0.96
CR006PR	6½" Diameter x ¾" Height, Wide Rim Plate	Dozen	37.83	1	8	1.24
CR007PR	7½" Diameter x ¾" Height, Wide Rim Plate	Dozen	37.41	1	6	1.31
CR009PR	¼" Diameter x ⅞" Height, Wide Rim Plate	Dozen	36.55	1	4	1.17
CR010PR	10 ½" Diameter x ⅞" Height, Wide Rim Plate	Dozen	46.72	1	4	1.56
CR012PR	11¾" Diameter x 1" Height, Wide Rim Plate	Dozen	48.90	1	4	1.90
CR710PR	10¼" Diameter x 1" Height, 3-Section Compartment Plate	Dozen	21.34	1	2	0.71



CR209PR



CR212PR



CR213PR

Item	Description	U/M	Weight Gross lbs	Inner Pack	Master Pack	Cu. Ft.
CR209PR	9 ½" x 7 ¼" x ¾", Platter	Dozen	27.56	1	4	0.87
CR212PR	12" x 9" x ¾", Platter	Dozen	44.48	1	4	1.53
CR213PR	13½" x 10½" x 1", Platter	Dozen	42.35	0.50	3	1.57

MELAMINE

# Color Pure Red



CR106PR



CR107PR



CR109PR



CR110PR

Item	Description	U/M	Weight Gross lbs	Inner Pack	Master Pack	Cu. Ft.
CR106PR	6 1/2" Diameter x 3/4" Height, Narrow Rim Plate	Dozen	36.42	1	8	1.31
CR107PR	7 1/4" Diameter x 5/8" Height, Narrow Rim Plate	Dozen	32.54	1	6	1.07
CR109PR	9" Diameter x 7/8" Height, Narrow Rim Plate	Dozen	35.47	1	4	1.33
CR110PR	10 1/2" Diameter x 3/4" Height, Narrow Rim Plate	Dozen	41.78	1	4	1.45



CR5077PR



CR5716PR



CR5809PR



CR5810PR



CR5811PR



CR5608PR



CR804PR



CR805PR



CR806PR



CR807PR

Item	Description	U/M	Weight Gross lbs	Inner Pack	Master Pack	Cu. Ft.
CR5077PR	8 oz, 7 3/4" Diameter x 1 1/2" Height, Wide Rim Salad Bowl	Dozen	48.57	1	8	1.93
CR5716PR	18 oz, 7 1/2" Diameter x 1 3/4" Height, Soup Bowl	Dozen	40.45	1	6	1.56
CR5809PR	13 oz, 9 1/4" Diameter x 1 3/8" Height, Salad Bowl	Dozen	39.64	1	4	1.42
CR5810PR	12 oz, 10 1/4" Diameter x 1 1/2" Height, Pasta Bowl	Dozen	39.95	1	3	1.34
CR5811PR	16 oz, 11 1/4" Diameter x 1 5/8" Height, Pasta Bowl	Dozen	42.13	0.50	3	2.12
CR5608PR	8 oz, 6" Diameter x 1 1/2" Height, Salad Bowl	Dozen	41.01	1	8	1.26
CR804PR	12 oz, 6 1/2" Diameter x 1 7/8" Low Side Height (3 1/4" High Side Height), Cascade Bowl	Dozen	42.95	1	6	1.78
CR805PR	16 oz, 8 1/8" Diameter x 2 1/4" Low Side Height (4 1/8" High Side Height), Cascade Bowl	Dozen	23.81	1	2	1.02
CR806PR	24 oz, 9 1/4" Diameter x 2 3/4" Low Side Height (5" High Side Height), Cascade Bowl	Dozen	31.88	1	2	1.52
CR807PR	35 oz, 10 1/4" Diameter x 2 7/8" Low Side Height (5 1/2" High Side Height), Cascade Bowl	Dozen	37.31	1	2	1.92



# Color Pure Red

2023



CR5807PR



CR5804PR



CR5712PR



CR9016PR



CR5510PR



CR305PR

Item	Description	U/M	Weight Gross lbs	Inner Pack	Master Pack	Cu. Ft.
CR5807PR	32 oz, 7½" Diameter x 2⅝" Height, Salad Bowl	Dozen	31.75	1	4	1.35
CR5804PR	10 oz, 4⅝" Diameter x 2¼" Height, Soup Bowl	Dozen	31.75	1	6	1.43
CR5712PR	15 oz, 7¼" Diameter x 1⅞" Height, Soup Bowl	Dozen	45.55	1	6	1.57
CR9016PR	10 oz, 4" Diameter x 2⅜" Height, Soup Mug	Dozen	29.50	1	5	1.76
CR5510PR	10 oz, 5½" Diameter x 2½" Height, Soup Bowl	Dozen	40.76	1	8	1.67
CR305PR	10 oz, 4⅝" Diameter x 2" Height, Soup Bowl with 2½" Handle	Dozen	18.02	1	4	1.44



CR9303PR



CR9108PR



CR303PR



CR313PR



CR5044PR



CR9018PR



CR9010PR



CR9035PR



ML9011PR



N-901PR



ML536PR1



ML538PR1

Item	Description	U/M	Weight Gross lbs	Inner Pack	Master Pack	Cu. Ft.
CR9303PR	5½" Diameter x ⅝" Height, Saucer For CR303/CR9018	Dozen	37.46	1	10	1.43
CR9108PR	5½" Diameter x ¾" Height, Saucer For CR313/CR5044/N-901/ML9011	Dozen	37.70	1	10	1.34
CR303PR	7 oz, 4" Diameter x 2⅞" Height, Bouillon Cup	Dozen	26.68	1	8	1.19
CR313PR	8 oz, 4 ¼" Diameter x 2⅞" Height, Bouillon Cup	Dozen	27.71	1	8	1.10
CR5044PR	4 oz, 4 ¾" Diameter x 1⅜" Height, Salad Bowl	Dozen	23.10	1	8	0.79
CR9018PR	7 oz, 3⅝" Diameter x 3⅝" Height, Mug/Cup	Dozen	48.90	1	8	2.39
CR9010PR	8 oz, 2⅞" Diameter x 3⅞" Height, Mug	Dozen	28.46	1	4	1.36
CR9035PR	10 oz, 3⅝" Diameter x 3⅝" Height, Mug	Dozen	32.23	1	5	1.74
ML9011PR	7oz, 3¼" Diameter x 2¾" Height, Stacking Cup	Dozen	16.25	1	5	1.42
N-901PR	8 oz, 3" Diameter x 3¾" Height, Bulbous Mug	Dozen	29.59	0.50	5	1.77
ML536PR1	2½ oz, 2⅞" Diameter x 1⅜" Height, Smooth Ramekin	Dozen	48.05	1	48	2.05
ML538PR1	4 oz, 3⅞" Diameter x 1¾" Height, Smooth Ramekin	Dozen	50.71	1	24	2.49

MELAMINE

# Color Purple

MELAMINE



Platter • Compartment Plate •  
Soup Bowl • Soup Spoon • Wide  
Rim Plate • Mug • Saucer





CR005BU



CR006BU



CR007BU



CR009BU



CR010BU



CR012BU



CR710BU

Item	Description	U/M	Weight Gross lbs	Inner Pack	Master Pack	Cu. Ft.
CR005BU	5½" Diameter x ¾" Height, Wide Rim Plate	Dozen	28.13	1	8	0.96
CR006BU	6½" Diameter x ¾" Height, Wide Rim Plate	Dozen	37.83	1	8	1.24
CR007BU	7½" Diameter x ¾" Height, Wide Rim Plate	Dozen	37.41	1	6	1.31
CR009BU	9¼" Diameter x 7⁄8" Height, Wide Rim Plate	Dozen	36.55	1	4	1.17
CR010BU	10½" Diameter x 7⁄8" Height, Wide Rim Plate	Dozen	46.72	1	4	1.56
CR012BU	11¾" Diameter x 1" Height, Wide Rim Plate	Dozen	48.90	1	4	1.90
CR710BU	10¼" Diameter x 1" Height, 3-Section Compartment Plate	Dozen	21.34	1	2	0.71



CR209BU



CR213BU



CR212BU

Item	Description	U/M	Weight Gross lbs	Inner Pack	Master Pack	Cu. Ft.
CR209BU	9½" x 7¼" x ¾", Platter	Dozen	27.56	1	4	0.87
CR212BU	12" x 9" x ¾", Platter	Dozen	44.48	1	4	1.53
CR213BU	13½" x 10½" x 1", Platter	Dozen	42.35	0.50	3	1.57

# Color Purple

MELAMINE



CR106BU



CR107BU



CR109BU



CR110BU

Item	Description	U/M	Weight Gross lbs	Inner Pack	Master Pack	Cu. Ft.
CR106BU	6 1/2" Diameter x 3/4" Height, Narrow Rim Plate	Dozen	36.42	1	8	1.31
CR107BU	7 1/4" Diameter x 5/8" Height, Narrow Rim Plate	Dozen	32.54	1	6	1.07
CR109BU	9" Diameter x 7/8" Height, Narrow Rim Plate	Dozen	35.47	1	4	1.33
CR110BU	10 1/2" Diameter x 3/4" Height, Narrow Rim Plate	Dozen	41.78	1	4	1.45



CR5077BU



CR5716BU



CR5809BU



CR5810BU



CR5811BU



CR5608BU

Item	Description	U/M	Weight Gross lbs	Inner Pack	Master Pack	Cu. Ft.
CR5077BU	8 oz, 3/4" Diameter x 1 1/2" Height, Wide Rim Salad Bowl	Dozen	48.57	1	8	1.93
CR5716BU	18 oz, 7 1/2" Diameter x 1 3/4" Height, Soup Bowl	Dozen	40.45	1	6	1.56
CR5809BU	13 oz, 9 1/4" Diameter x 1 3/8" Height, Salad Bowl	Dozen	39.64	1	4	1.42
CR5810BU	12 oz, 10 1/4" Diameter x 1 1/2" Height, Pasta Bowl	Dozen	39.95	1	3	1.34
CR5811BU	16 oz, 11 1/4" Diameter x 1 5/8" Height, Pasta Bowl	Dozen	42.13	0.50	3	2.12
CR5608BU	8 oz, 6" Diameter x 1 1/2" Height, Salad Bowl	Dozen	41.01	1	8	1.26



CR5807BU



CR5804BU



CR5712BU



CR9016BU



CR5510BU



CR305BU



7000B

Item	Description	U/M	Weight Gross lbs	Inner Pack	Master Pack	Cu. Ft.
CR5807BU	32 oz, 7½" Diameter x 2⅝" Height, Salad Bowl	Dozen	31.75	1	4	1.35
CR5804BU	10 oz, 4⅝" Diameter x 2¼" Height, Soup Bowl	Dozen	31.75	1	6	1.43
CR5712BU	15 oz, 7¼" Diameter x 1⅞" Height, Soup Bowl	Dozen	45.55	1	6	1.57
CR9016BU	10 oz, 4" Diameter x 2⅝" Height, Soup Mug	Dozen	29.50	1	5	1.76
CR5510BU	10 oz, 5 ½" Diameter x 2⅞" Height, Soup Bowl	Dozen	40.76	1	8	1.67
CR305BU	10 oz, 4⅝" Diameter x 2" Height, Soup Bowl with 2⅞" Handle	Dozen	18.02	1	4	1.44
7000B	1 oz, 6⅜" x 1⅞", Spoon	Dozen	31.86	5	40	2.00

**\*\*Soup Spoon is not NSF Certified.\*\***



CR9035BU



CR9010BU



CR9018BU



CR313BU



CR5044BU



CR303BU



CR9303BU



CR9108BU



ML536BU1



ML538BU1

Item	Description	U/M	Weight Gross lbs	Inner Pack	Master Pack	Cu. Ft.
CR9035BU	10 oz, 3⅝" Diameter x 3⅞" Height, Mug	Dozen	32.23	1	5	1.74
CR9010BU	8 oz, 2⅞" Diameter x 3⅞" Height, Mug	Dozen	28.46	1	4	1.36
CR9018BU	7 oz, 3⅞" Diameter x 3⅞" Height, Mug/Cup	Dozen	48.90	1	8	2.39
CR313BU	8 oz, 4¼" Diameter x 2⅞" Height, Bouillon Cup	Dozen	27.71	1	8	1.10
CR5044BU	4 oz, 4¾" Diameter x 1⅜" Height, Salad Bowl	Dozen	23.10	1	8	0.79
CR303BU	7 oz, 4" Diameter x 2⅞" Height, Bouillon Cup	Dozen	26.68	1	8	1.19
CR9303BU	5½" Diameter x ⅝" Height, Saucer For CR303/CR9018	Dozen	37.46	1	10	1.43
CR9108BU	5½" Diameter x ¾" Height, Saucer For CR313/CR5044	Dozen	37.70	1	10	1.34
ML536BU1	2½ oz, 2⅞" Diameter x 1¾" Height, Smooth Ramekin	Dozen	48.05	1	48	2.05
ML538BU1	4 oz, 3⅞" Diameter x 1¾" Height, Smooth Ramekin	Dozen	50.71	1	24	2.49

# Color White

MELAMINE



Mug • Saucer • Narrow Rim Plate  
Platter • Compartment Plate •  
Soup Bowl • Soup Spoon







CR005W



CR006W



CR007W



CR009W



CR010W



CR012W



CR710W

Item	Description	U/M	Weight Gross lbs	Inner Pack	Master Pack	Cu. Ft.
CR005W	5½" Diameter x ¾" Height, Wide Rim Plate	Dozen	28.13	1	8	0.96
CR006W	6½" Diameter x ¾" Height, Wide Rim Plate	Dozen	37.83	1	8	1.24
CR007W	7⅝" Diameter x ¾" Height, Wide Rim Plate	Dozen	37.41	1	6	1.31
CR009W	9¼" Diameter x ⅞" Height, Wide Rim Plate	Dozen	36.55	1	4	1.17
CR010W	10 ½" Diameter x ⅞" Height, Wide Rim Plate	Dozen	46.72	1	4	1.56
CR012W	11 ¾" Diameter x 1" Height, Wide Rim Plate	Dozen	48.90	1	4	1.90
CR710W	10¼" Diameter x 1" Height, 3-Section Compartment Plate	Dozen	21.34	1	2	0.71



CR209W



CR212W



CR213W

Item	Description	U/M	Weight Gross lbs	Inner Pack	Master Pack	Cu. Ft.
CR209W	9½" x 7¼" x ¾", Platter	Dozen	27.56	1	4	0.87
CR212W	12" x 9" x ¾", Platter	Dozen	44.48	1	4	1.53
CR213W	13½" x 10½" x 1", Platter	Dozen	42.35	0.50	3	1.57

# Color White



CR106W



CR107W



CR109W



CR110W

Item	Description	U/M	Weight Gross lbs	Inner Pack	Master Pack	Cu. Ft.
CR106W	6½" Diameter x ¾" Height, Narrow Rim Plate	Dozen	36.42	1	8	1.31
CR107W	7¼" Diameter x ⅝" Height, Narrow Rim Plate	Dozen	32.54	1	6	1.07
CR109W	9" Diameter x ⅞" Height, Narrow Rim Plate	Dozen	35.47	1	4	1.33
CR110W	10½" Diameter x ¾" Height, Narrow Rim Plate	Dozen	41.78	1	4	1.45



CR5077W



CR5716W



CR5809W



CR5810W



CR5811W



CR5608W

Item	Description	U/M	Weight Gross lbs	Inner Pack	Master Pack	Cu. Ft.
CR5077W	8 oz, 7¾" Diameter x 1½" Height, Wide Rim Salad Bowl	Dozen	48.57	1	8	1.93
CR5716W	18 oz, 7½" Diameter x 1¾" Height, Soup Bowl	Dozen	40.45	1	6	1.56
CR5809W	13 oz, 9¼" Diameter x 1⅜" Height, Salad Bowl	Dozen	39.64	1	4	1.42
CR5810W	12 oz, 10¼" Diameter x 1½" Height, Pasta Bowl	Dozen	39.95	1	3	1.34
CR5811W	16 oz, 11¼" Diameter x 1⅝" Height, Pasta Bowl	Dozen	42.13	0.50	3	2.12
CR5608W	8 oz, 6" Diameter x 1½" Height, Salad Bowl	Dozen	41.01	1	8	1.26





CR5807W



CR5804W



CR5712W



CR9016W



CR5510W



CR305W



7000W

Item	Description	U/M	Weight Gross lbs	Inner Pack	Master Pack	Cu. Ft.
CR5807W	32 oz, 7½" Diameter x 2⅝" Height, Salad Bowl	Dozen	31.75	1	4	1.35
CR5804W	10 oz, 4⅝" Diameter x 2¼" Height, Soup Bowl	Dozen	31.75	1	6	1.43
CR5712W	15 oz, 7¼" Diameter x 1⅞" Height, Soup Bowl	Dozen	45.55	1	6	1.57
CR9016W	10 oz, 4" Diameter x 2⅜" Height, Soup Mug	Dozen	29.50	1	5	1.76
CR5510W	10 oz, 5 ½" Diameter x 2⅝" Height, Soup Bowl	Dozen	40.76	1	8	1.67
CR305W	10 oz, 4⅝" Diameter x 2" Height, Soup Bowl with 2⅞" Handle	Dozen	18.02	1	4	1.44
7000W	1 oz, 6⅜" x 1⅞", Spoon	Dozen	31.86	5	40	2.00

**\*\*Soup Spoon is not NSF Certified.\*\***



CR9035W



CR9010W



ML9011W



CR901W



CR9018W



CR313W



CR5044W



CR303W



CR9303W



CR9108W

Item	Description	U/M	Weight Gross lbs	Inner Pack	Master Pack	Cu. Ft.
CR9035W	10 oz, 3⅜" Diameter x 3⅞" Height, Mug	Dozen	32.23	1	5	1.74
CR9010W	8 oz, 2⅞" Diameter x 3⅞" Height, Mug	Dozen	28.46	1	4	1.36
ML9011W	7 oz, 3¼" Diameter x 2¾" Height, Stacking Cup	Dozen	16.25	1	5	1.42
ML901W	8 oz, 3" Diameter x 3¾" Height, Bulbous Mug	Dozen	29.59	0.50	5	1.77
CR9018W	7 oz, 3⅞" Diameter x 3⅞" Height, Mug/Cup	Dozen	48.90	1	8	2.39
CR313W	8 oz, 4¼" Diameter x 2¼" Height, Bouillon Cup	Dozen	27.71	1	8	1.10
CR5044W	4 oz, 4¾" Diameter x 1⅜" Height, Salad Bowl	Dozen	23.10	1	8	0.79
CR303W	7 oz, 4" Diameter x 2⅝" Height, Bouillon Cup	Dozen	26.68	1	8	1.19
CR9303W	5½" Diameter x ⅝" Height, Saucer For CR303/CR9018	Dozen	37.46	1	10	1.43
CR9108W	5½" Diameter x ¾" Height, Saucer For CR313/CR5044/ML901/ML9011	Dozen	37.70	1	10	1.34

# Color Yellow

MELAMINE



Salad Bowl • Platter • Wide Rim  
Plates • Cascade Bowl • Mug





Item	Description	U/M	Weight Gross lbs	Inner Pack	Master Pack	Cu. Ft.
CR005YW	5½" Diameter x ¾" Height, Wide Rim Plate	Dozen	28.13	1	8	0.96
CR006YW	6 ½" Diameter x ¾" Height, Wide Rim Plate	Dozen	37.83	1	8	1.24
CR007YW	7¾" Diameter x ¾" Height, Wide Rim Plate	Dozen	37.41	1	6	1.31
CR009YW	9¼" Diameter x ¾" Height, Wide Rim Plate	Dozen	36.55	1	4	1.17
CR010YW	10½" Diameter x ¾" Height, Wide Rim Plate	Dozen	46.72	1	4	1.56
CR012YW	11¾" Diameter x 1" Height, Wide Rim Plate	Dozen	48.90	1	4	1.90
CR710YW	10¼" Diameter x 1" Height, 3-Section Compartment Plate	Dozen	21.34	1	2	0.71



Item	Description	U/M	Weight Gross lbs	Inner Pack	Master Pack	Cu. Ft.
CR209YW	9 ½" x 7 ¼" x ¾", Platter	Dozen	27.56	1	4	0.87
CR212YW	12" x 9" x ¾", Platter	Dozen	44.48	1	4	1.53
CR213YW	13½" x 10½" x 1", Platter	Dozen	42.35	0.50	3	1.57

# Color Yellow



CR106YW



CR110YW



CR109YW



CR9010YW

Item	Description	U/M	Weight Gross lbs	Inner Pack	Master Pack	Cu. Ft.
CR106YW	6½" Diameter x ¾" Height, Narrow Rim Plate	Dozen	36.42	1	8	1.31
CR107YW	7¼" Diameter x ⅝" Height, Narrow Rim Plate	Dozen	32.54	1	6	1.07
CR109YW	9" Diameter x ⅞" Height, Narrow Rim Plate	Dozen	35.47	1	4	1.33
CR110YW	1 ½" Diameter x ¾" Height, Narrow Rim Plate	Dozen	41.78	1	4	1.45



CR5077YW



CR5716YW



CR5809YW



CR5810YW



CR5811YW



CR5608YW



CR804YW



CR805YW



CR806YW



CR807YW

Item	Description	U/M	Weight Gross lbs	Inner Pack	Master Pack	Cu. Ft.
CR5077YW	8 oz, 7¾" Diameter x 1½" Height, Wide Rim Salad Bowl	Dozen	48.57	1	8	1.93
CR5716YW	18 oz, 7½" Diameter x 1¾" Height, Soup Bowl	Dozen	40.45	1	6	1.56
CR5809YW	13 oz, 9¼" Diameter x 1¾" Height, Salad Bowl	Dozen	39.64	1	4	1.42
CR5810YW	12 oz, 10¼" Diameter x 1½" Height, Pasta Bowl	Dozen	39.95	1	3	1.34
CR5811YW	16 oz, 11¼" Diameter x 1⅝" Height, Pasta Bowl	Dozen	42.13	0.50	3	2.12
CR5608YW	8 oz, 6" Diameter x 1½" Height, Salad Bowl	Dozen	41.01	1	8	1.26
CR804YW	12 oz, 6½" Diameter x 1⅞" Low Side Height (3¼" High Side Height), Cascade Bowl	Dozen	42.95	1	6	1.78
CR805YW	16 oz, 8⅞" Diameter x 2¼" Low Side Height (4⅞" High Side Height), Cascade Bowl	Dozen	23.81	1	2	1.02
CR806YW	24 oz, 9¼" Diameter x 2¾" Low Side Height (5" High Side Height), Cascade Bowl	Dozen	31.88	1	2	1.52
CR807YW	35 oz, 10¼" Diameter x 2⅞" Low Side Height (5½" High Side Height), Cascade Bowl	Dozen	37.31	1	2	1.92



# Color Yellow

2023



CR5807YW



CR5804YW



CR5712YW



CR5510YW



CR305YW



7000W



CR9016YW

Item	Description	U/M	Weight Gross lbs	Inner Pack	Master Pack	Cu. Ft.
CR5807YW	32 oz, 7½" Diameter x 2⅝" Height, Salad Bowl	Dozen	31.75	1	4	1.35
CR5804YW	10 oz, 4⅝" Diameter x 2¼" Height, Soup Bowl	Dozen	31.75	1	6	1.43
CR5712YW	15 oz, 7¼" Diameter x 1⅞" Height, Soup Bowl	Dozen	45.55	1	6	1.57
CR5510YW	10 oz, 5 ½" Diameter x 2⅞" Height, Soup Bowl	Dozen	40.76	1	8	1.67
CR305YW	10 oz, 4⅝" Diameter x 2" Height, Soup Bowl with 2⅞" Handle	Dozen	18.02	1	4	1.44
7000Y	1 oz, 6⅜" x 1⅞", Spoon	Dozen	31.86	5	40	2.00
CR9016YW	10 oz, 4" Diameter x 2⅜" Height, Soup Mug	Dozen	29.50	1	5	1.76

**\*\*Soup Spoon is not NSF Certified.\*\***



CR9035YW



CR9010YW



CR9018YW



CR313YW



CR5044YW



CR303YW



CR9303YW



CR9108YW



ML536YW1



ML538YW1

Item	Description	U/M	Weight Gross lbs	Inner Pack	Master Pack	Cu. Ft.
CR9035YW	10 oz, 3⅝" Diameter x 3⅞" Height, Mug	Dozen	32.23	1	5	1.74
CR9010YW	8 oz, 2⅞" Diameter x 3⅞" Height, Mug	Dozen	28.46	1	4	1.36
CR9018YW	7 oz, 3⅝" Diameter x 3⅞" Height, Mug/Cup	Dozen	48.90	1	8	2.39
CR313YW	8 oz, 4 ¼" Diameter x 2⅞" Height, Bouillon Cup	Dozen	27.71	1	8	1.10
CR5044YW	4 oz, 4 ¾" Diameter x 1⅞" Height, Salad Bowl	Dozen	23.10	1	8	0.79
CR303YW	7 oz, 4" Diameter x 2⅞" Height, Bouillon Cup	Dozen	26.68	1	8	1.19
CR9303YW	5½" Diameter x ⅝" Height, Saucer For CR303/CR9018	Dozen	37.46	1	10	1.43
CR9108YW	5½" Diameter x ¾" Height, Saucer For CR313/CR5044	Dozen	37.70	1	10	1.34
ML536YW1	2½ oz, 2 ⅞" Diameter x 1⅞" Height, Smooth Ramekin	Dozen	48.05	1	48	2.05
ML538YW1	4 oz, 3⅝" Diameter x 1¾" Height, Smooth Ramekin	Dozen	50.71	1	24	2.49

MELAMINE

# Nustone Tan

MELAMINE



Stacking Cup • Saucer  
Platter • Compartment Plate •  
Soup Bowl • Cereal Bowl







NS105T



NS106T



NS107T



NS108T



NS109T



NS110T

Item	Description	U/M	Weight Gross lbs	Inner Pack	Master Pack	Cu. Ft.
NS105T	5½" Diameter x ⅝" Height, Round Plate	Dozen	36.24	1	20	2.05
NS106T	6½" Diameter x ⅝" Height, Round Plate	Dozen	52.78	1	20	2.38
NS107T	7¼" Diameter x ¾" Height, Dessert Plate	Dozen	38.94	1	10	1.71
NS108T	8" Diameter x ¾" Height, Dinner Plate	Dozen	34.26	1	8	1.49
NS109T	9" Diameter x ¾" Height, Dinner Plate	Dozen	43.89	1	8	1.98
NS110T	10¼" Diameter x 1" Height, Dinner Plate	Dozen	47.74	1	6	2.25



Item	Description	U/M	Weight Gross lbs	Inner Pack	Master Pack	Cu. Ft.
NS701T	8¾" Diameter x 1¼" Height, 3-Section Deep Compartment Plate	Dozen	46.30	0.50	6	3.76
NS702T	10" Diameter x ¾" Height, 3-Section Compartment Plate	Dozen	35.27	1	6	1.68
NS703T	10¼" Diameter x ¾" Height, 3-Section Compartment Plate	Dozen	22.93	0.50	3	1.53
NS608T	8¼" Diameter x 1¼" Height, Tortilla Server with Lid	Dozen	70.50	2	6	4.49
NS608-1T	8¼" Diameter x 1¼" Height, 3-Section Deep Divided Server, Tan (Lid Sold Separately)	Dozen	47.30	0.50	6	1.59
NS608CT	8¼" Diameter, Lid Only, Fits NS608-1T, Tan	Dozen	32.12	0.50	6	1.97
NS608-1R	8¼" Diameter x 1¼" Height, 3-Section Deep Divided Server, Red (Lid Sold Separately)	Dozen	47.30	0.50	6	1.59
NS608CR	8¼" Diameter, Lid Only, Fits NS608-1R, Red	Dozen	32.12	0.50	6	1.97
NS608R	8 ¼" Diameter x 1¼" Height, Tortilla Server with Lid, Red	Dozen	70.50	0.50	6	4.49

# Nustone Tan

MELAMINE



NS510T



NS512T



NS513T



NS515T



NS516T

Item	Description	U/M	Weight Gross lbs	Inner Pack	Master Pack	Cu. Ft.
NS510T	9½" x 6¾" x 7⁄8", Narrow Rim Platter	Dozen	19.05	1	4	0.87
NS512T	11½" x 8" x 1", Narrow Rim Platter	Dozen	22.77	0.50	3	1.13
NS513T	13" x 8½" x 1", Narrow Rim Platter	Dozen	27.56	0.50	3	1.41
NS515T	13¼" x 9⁵⁄₈" x 1½", Narrow Rim Platter	Dozen	22.31	0.50	2	1.27
NS516T	15½" x 10⁷⁄₈" x 1½", Narrow Rim Platter	Dozen	31.53	0.50	2	1.59



NS209T



NS211T



NS212T



NS215T

Item	Description	U/M	Weight Gross lbs	Inner Pack	Master Pack	Cu. Ft.
NS209T	9½" x 6¾" x 5⁄₈", Rectangular Platter	Dozen	48.50	1	10	1.74
NS211T	11½" x 1½" x ¾", Rectangular Platter	Dozen	45.19	1	6	1.74
NS212T	12½" x 9" x 7⁄₈", Rectangular Platter	Dozen	53.57	1	6	2.21
NS215T	15" x 10 5⁄₈" x 7⁄₈", Rectangular Platter	Dozen	47.62	0.50	3	2.04





Item	Description	U/M	Weight Gross lbs	Inner Pack	Master Pack	Cu. Ft.
NS5060T	22 oz, 6 <sup>7</sup> / <sub>8</sub> " Diameter x 2 <sup>1</sup> / <sub>4</sub> " Height, Rimless Bowl	Dozen	37.92	1	8	2.07
NS5065T	32 oz, 7 <sup>1</sup> / <sub>2</sub> " Diameter x 2 <sup>1</sup> / <sub>2</sub> " Height, Rimless Bowl	Dozen	43.98	1	8	2.59
NS5070T	41 oz, 8" Diameter x 2 <sup>5</sup> / <sub>8</sub> " Height, Rimless Bowl	Dozen	41.45	1	6	2.10
NS5075T	52 oz, 8 <sup>3</sup> / <sub>4</sub> " Diameter x 2 <sup>7</sup> / <sub>8</sub> " Height, Rimless Bowl	Dozen	47.18	1	6	2.43
NS5085T	70 oz, 9 <sup>3</sup> / <sub>4</sub> " Diameter x 3 <sup>1</sup> / <sub>4</sub> " Height, Rimless Bowl	Dozen	48.06	0.50	4	3.24
NS5095T	96 oz, 11" Diameter x 3 <sup>1</sup> / <sub>4</sub> " Height, Rimless Bowl	Dozen	51.15	0.50	3	3.66



Item	Description	U/M	Weight Gross lbs	Inner Pack	Master Pack	Cu. Ft.
NS502T	2 <sup>1</sup> / <sub>2</sub> oz, 2 <sup>7</sup> / <sub>8</sub> " Diameter x 1 <sup>1</sup> / <sub>2</sub> " Height, Sauce Cup/Ramkin	Dozen	25.26	1	20	1.11
NS503T	4 oz, 3 <sup>1</sup> / <sub>4</sub> " Diameter x 1 <sup>1</sup> / <sub>2</sub> " Height, Sauce Cup/Ramekin	Dozen	34.06	1	20	1.58
ML9011T	7 oz, 3 <sup>1</sup> / <sub>4</sub> " Diameter x 2 <sup>3</sup> / <sub>4</sub> " Height, Stacking Cup	Dozen	16.25	1	5	1.42
ML901I	8 oz, 3" Diameter x 3 <sup>3</sup> / <sub>4</sub> " Height, Bulbous Mug, Ivory	Dozen	29.59	0.50	5	1.77
ML901S	8 oz, 3" Diameter x 3 <sup>3</sup> / <sub>4</sub> " Height, Bulbous Mug, Sand	Dozen	29.59	0.50	5	1.77
ML901T	8 oz, 3" Diameter x 3 <sup>3</sup> / <sub>4</sub> " Height, Bulbous Mug, Tan	Dozen	29.59	0.50	5	1.77
NS302T	8 oz, 3 <sup>7</sup> / <sub>8</sub> " Diameter x 2 <sup>1</sup> / <sub>8</sub> " Height, Bouillon Cup	Dozen	34.83	1	16	1.31
NS303T	4 oz, 4 <sup>3</sup> / <sub>4</sub> " Diameter x 1 <sup>1</sup> / <sub>4</sub> " Height, Fruit Bowl	Dozen	30.42	1	16	1.33
NS304T	5 oz, 4 <sup>3</sup> / <sub>4</sub> " Diameter x 1 <sup>5</sup> / <sub>8</sub> " Height, Fruit Bowl	Dozen	32.56	1	16	1.57
NS305T	10 oz, 5 <sup>1</sup> / <sub>2</sub> " Diameter x 1 <sup>7</sup> / <sub>8</sub> " Height, Grapefruit Bowl	Dozen	24.67	1	8	1.34
NS306T	13 oz, 5 <sup>3</sup> / <sub>4</sub> " Diameter x 2 <sup>1</sup> / <sub>8</sub> " Height, Grapefruit Bowl	Dozen	25.29	1	8	1.45
NS307T	12 oz, 6 <sup>3</sup> / <sub>8</sub> " Diameter x 1 <sup>5</sup> / <sub>8</sub> " Height, Soup/Cereal Bowl	Dozen	53.35	1	10	1.25
NS314T	11 oz, 4 <sup>7</sup> / <sub>8</sub> " Diameter x 1 <sup>3</sup> / <sub>4</sub> " Height, Nappie	Dozen	25.37	1	8	1.13
NS315T	15 oz, 5 <sup>1</sup> / <sub>4</sub> " Diameter x 2 <sup>1</sup> / <sub>8</sub> " Height, Nappie	Dozen	27.56	1	8	1.43

# *Nustone White*

MELAMINE



Rectangular Platter •  
Compartment Plate • Nappie •  
Dinner Plate • Fruit Bowl



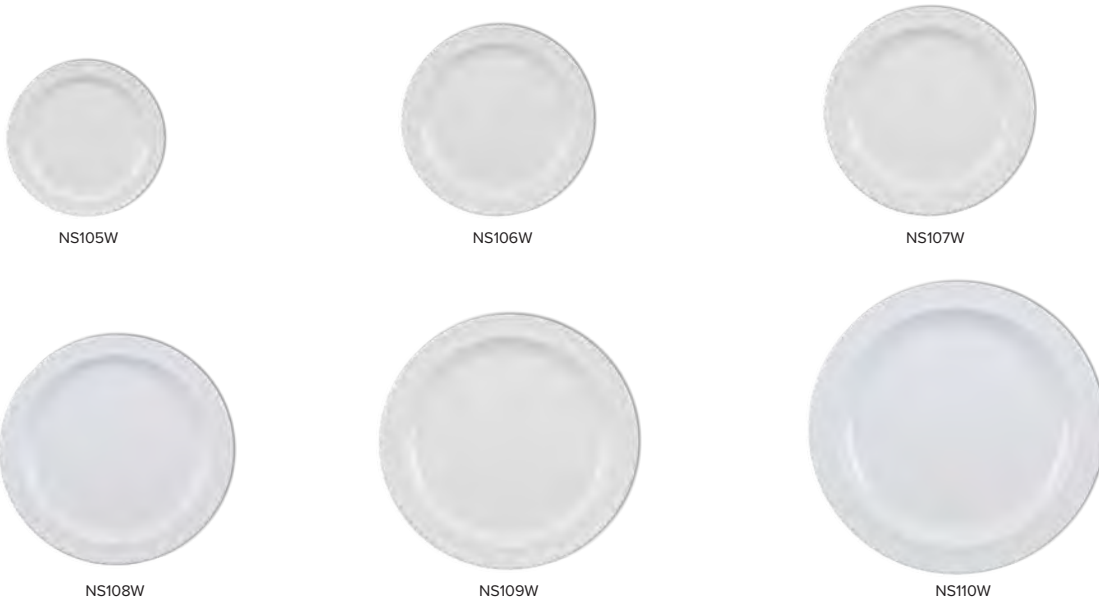

Item	Description	U/M	Weight Gross lbs	Inner Pack	Master Pack	Cu. Ft.
NS105W	5 1/2" Diameter x 5/8" Height, Round Plate	Dozen	36.24	1	20	2.05
NS106W	6 1/2" Diameter x 5/8" Height, Round Plate	Dozen	52.78	1	20	2.38
NS107W	7 1/4" Diameter x 3/4" Height, Dessert Plate	Dozen	38.94	1	10	1.71
NS108W	8" Diameter x 3/4" Height, Dinner Plate	Dozen	34.26	1	8	1.49
NS109W	9" Diameter x 3/4" Height, Dinner Plate	Dozen	43.89	1	8	1.98
NS110W	10 1/4" Diameter x 1" Height, Dinner Plate	Dozen	47.74	1	6	2.25



Item	Description	U/M	Weight Gross lbs	Inner Pack	Master Pack	Cu. Ft.
NS701W	8 3/4" Diameter x 1 1/4" Height, 3-Section Compartment Plate	Dozen	46.30	0.50	6	3.76
NS702W	10" Diameter x 3/4" Height, 3-Section Compartment Plate	Dozen	35.27	1	6	1.68
NS703W	10 1/4" Diameter x 3/4" Height, 3-Section Compartment Plate	Dozen	22.93	0.50	3	1.53
NS608W	8 1/4" Diameter x 1 1/4" Height, Tortilla Server with Lid	Dozen	70.50	2	6	4.49
NS608-1W	8 1/4" Diameter x 1 1/4" Height, Deep Divided Server (Lid Sold Separately)	Dozen	47.30	0.50	6	1.59
NS608CW	8 1/4" Diameter, Fits N608-1W(Lid Only)	Dozen	32.12	0.50	6	1.97

# Nustone White

MELAMINE



NS510W



NS512W



NS513W



NS515W



NS516W

Item	Description	U/M	Weight Gross lbs	Inner Pack	Master Pack	Cu. Ft.
NS510W	9½" x 6¾" x 7⁄8", Narrow Rim Platter	Dozen	19.05	1	4	0.87
NS512W	11½" x 8" x 1", Narrow Rim Platter	Dozen	22.77	0.50	3	1.13
NS513W	13" x 8½" x 1", Narrow Rim Platter	Dozen	27.56	0.50	3	1.41
NS515W	13 ¼" x 9⁵⁄₈" x 1 1⁄₈", Narrow Rim Platter	Dozen	22.31	0.50	2	1.27
NS516W	15½" x 10⁷⁄₈" x 1 1⁄₈", Narrow Rim Platter	Dozen	31.53	0.50	2	1.59



NS209W



NS211W



NS212W



NS215W

Item	Description	U/M	Weight Gross lbs	Inner Pack	Master Pack	Cu. Ft.
NS209W	9½" x 6¾" x 5⁄₈", Rectangular Platter	Dozen	48.50	1	10	1.74
NS211W	11½" x 7½" x ¾", Rectangular Platter	Dozen	45.19	1	6	1.74
NS212W	12½" x 9" x 7⁄₈", Rectangular Platter	Dozen	53.57	1	6	2.21
NS215W	15" x 10⁵⁄₈" x 7⁄₈", Rectangular Platter	Dozen	47.62	0.50	3	2.04



Item	Description	U/M	Weight Gross lbs	Inner Pack	Master Pack	Cu. Ft.
NS5060W	22 oz, 6 <sup>7</sup> / <sub>8</sub> " Diameter x 2 <sup>1</sup> / <sub>4</sub> " Height, Rimless Bowl	Dozen	37.92	1	8	2.07
NS5065W	32 oz, 7 <sup>1</sup> / <sub>2</sub> " Diameter x 2 <sup>1</sup> / <sub>2</sub> " Height, Rimless Bowl	Dozen	43.98	1	8	2.59
NS5070W	41 oz, 8" Diameter x 2 <sup>5</sup> / <sub>8</sub> " Height, Rimless Bowl	Dozen	41.45	1	6	2.10
NS5075W	52 oz, 8 <sup>3</sup> / <sub>4</sub> " Diameter x 2 <sup>7</sup> / <sub>8</sub> " Height, Rimless Bowl	Dozen	47.18	1	6	2.43
NS5085W	70 oz, 9 <sup>3</sup> / <sub>4</sub> " Diameter x 3 <sup>1</sup> / <sub>4</sub> " Height, Rimless Bowl	Dozen	48.06	0.50	4	3.24
NS5095W	96 oz, 11" Diameter x 3 <sup>3</sup> / <sub>4</sub> " Height, Rimless Bowl	Dozen	51.15	0.50	3	3.66



Item	Description	U/M	Weight Gross lbs	Inner Pack	Master Pack	Cu. Ft.
NS502W	2 <sup>1</sup> / <sub>2</sub> oz, 2 <sup>7</sup> / <sub>8</sub> " Diameter x 1 <sup>1</sup> / <sub>2</sub> " Height, Sauce Cup/Ramekin	Dozen	25.26	1	20	1.11
NS503W	4 oz, 3 <sup>1</sup> / <sub>4</sub> " Diameter x 1 <sup>1</sup> / <sub>2</sub> " Height, Sauce Cup/Ramekin	Dozen	34.06	1	20	1.58
NS302W	8 oz, 3 <sup>7</sup> / <sub>8</sub> " Diameter x 2 <sup>1</sup> / <sub>8</sub> " Height, Bouillon Cup	Dozen	34.83	1	16	1.31
NS303W	4 oz, 4 <sup>3</sup> / <sub>4</sub> " Diameter x 1 <sup>1</sup> / <sub>4</sub> " Height, Fruit Bowl	Dozen	30.42	1	16	1.33
NS304W	5 oz, 4 <sup>3</sup> / <sub>4</sub> " Diameter x 1 <sup>5</sup> / <sub>8</sub> " Height, Fruit Bowl	Dozen	32.56	1	16	1.57
NS305W	10 oz, 5 <sup>1</sup> / <sub>2</sub> " Diameter x 1 <sup>7</sup> / <sub>8</sub> " Height, Grapefruit Bowl	Dozen	24.67	1	8	1.34
NS306W	13 oz, 5 <sup>3</sup> / <sub>4</sub> " Diameter x 2" Height, Grapefruit Bowl	Dozen	25.29	1	8	1.45
NS307W	12 oz, 6 <sup>3</sup> / <sub>8</sub> " Diameter x 1 <sup>5</sup> / <sub>8</sub> " Height, Soup/Cereal Bowl	Dozen	53.35	1	10	1.25
NS314W	11 oz, 4 <sup>7</sup> / <sub>8</sub> " Diameter x 1 <sup>3</sup> / <sub>4</sub> " Height, Nappie	Dozen	25.37	1	8	1.13
NS315W	15 oz, 5 <sup>1</sup> / <sub>4</sub> " Diameter x 2 <sup>1</sup> / <sub>8</sub> " Height, Nappie	Dozen	27.56	1	8	1.43

# Graham Dinnerware



Wide Rim Plate • Platter • Salad Bowls  
- Crackle Design -





# Graham Dinnerware

2023



DM005H      DM006H      DM007H      DM009H      DM010H      DM012H

Item	Description	U/M	Weight Gross lbs	Inner Pack	Master Pack	Cu. Ft.
DM005H	5½" Diameter x ¾" Height, Wide Rim Plate	Dozen	28.13	1	8	0.96
DM006H	6½" Diameter x ¾" Height, Wide Rim Plate	Dozen	37.83	1	8	1.24
DM007H	7⅝" Diameter x ¾" Height, Wide Rim Plate	Dozen	37.41	1	6	1.31
DM009H	9¼" Diameter x ⅞" Height, Wide Rim Plate	Dozen	36.55	1	4	1.17
DM010H	10½" Diameter x ⅞" Height, Wide Rim Plate	Dozen	46.72	1	4	1.56
DM012H	11¾" Diameter x 1" Height, Wide Rim Plate	Dozen	48.90	1	4	1.90



Item	Description	U/M	Weight Gross lbs	Inner Pack	Master Pack	Cu. Ft.
DM5811H	16 oz, 11¼" Diameter x 1⅝" Height, Pasta Bowl	Dozen	42.13	0.50	3	2.12
DM5608H	8 oz, 6" Diameter x 1½" Height, Salad Bowl	Dozen	41.01	1	8	1.26
DM5044H	4 oz, 4¾" Diameter x 1⅜" Height, Salad Bowl	Dozen	23.10	1	8	0.79
DM5807H	32 oz, 7½" Diameter x 2⅝" Height, Salad Bowl	Dozen	31.75	1	4	1.35



Item	Description	U/M	Weight Gross lbs	Inner Pack	Master Pack	Cu. Ft.
DM209H	9½" x 7¼" x ¾", Platter	Dozen	27.56	1	4	0.87
DM212H	12" x 9" x ⅞", Platter	Dozen	44.48	1	4	1.53
DM213H	13½" x 10½" x 1", Platter	Dozen	42.35	0.50	3	1.57

MELAMINE

# Graham Serving



Platter • Deep Bowl • Bowl with Handle • Tray  
- Crackle Design -



# Graham Serving and Display

2023



SD2118H



SD2121H

Item	Description	U/M	Weight Gross lbs	Inner Pack	Master Pack	Cu. Ft.
SD2118H	18" x 13 1/2" x 1 1/2", Oval Platter	Each	30.56	2	12	2.03
SD2121H	21" x 15" x 1 5/8", Oval Platter	Each	31.04	2	12	2.68



SD5609H



SD5613H



SD5612H



SD5614H



SD6015H



SD6018H

Item	Description	U/M	Weight Gross lbs	Inner Pack	Master Pack	Cu. Ft.
SD5609H	1 qt/32 oz, 8" Diameter x 2 1/4" Deep, Bowl with 1" Handle	Each	17.24	6	24	1.05
SD5612H	2 qt/64 oz, 11" Diameter x 3" Deep, Bowl with 1 1/4" Handle	Each	37.88	6	24	2.42
SD5613H	3 qt/96 oz, 12 1/4" Diameter x 3 1/4" Deep, Bowl with 1 1/4" Handle	Each	45.30	6	24	2.93
SD5614H	4 qt/128 oz, 12 7/8" Diameter x 3 1/2" Deep, Bowl with 1 1/4" Handle	Each	26.39	6	12	1.72
SD6015H	6 qt/192 oz, 12 1/4" Diameter x 4" Deep, Bowl with 1 3/8" Handle	Each	29.56	6	12	3.06
SD6018H	10 qt/320 oz, 14 3/4" Diameter x 4 3/4" Deep, Bowl with 1 5/8" Handle	Each	42.24	6	12	4.28

MELAMINE

# Graham Serving and Display

SD3324H



Item	Description	U/M	Weight Gross lbs	Inner Pack	Master Pack	Cu. Ft.
SD3324H	24" x 18" x 1¾", Rectangular Tray	Each	66.32	2	12	4.85

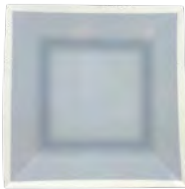

SD3206H

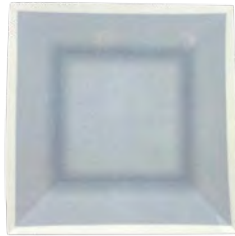

SD3208H

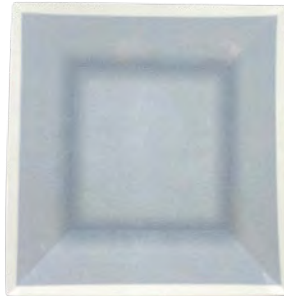

SD3210H

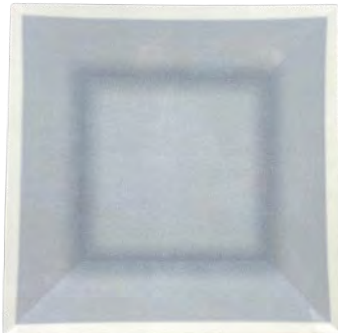

SD3212H

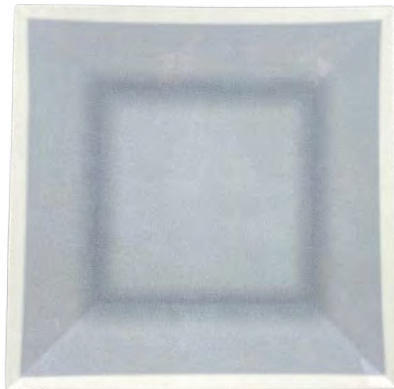

SD3214H

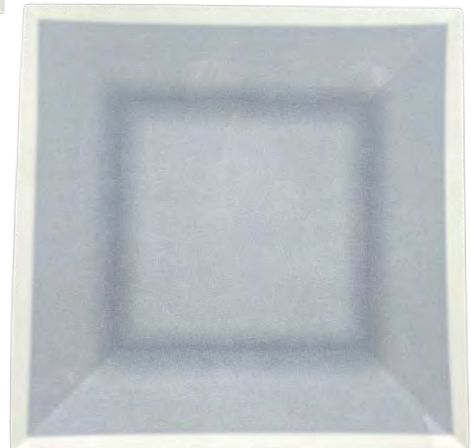

SD3216H



SD3314H



SD3318H

Item	Description	U/M	Weight Gross lbs	Inner Pack	Master Pack	Cu. Ft.
SD3206H	6" x 6" x ¾", Square Plate	Each	19.31	12	48	0.51
SD3208H	8" x 8" x 1", Square Plate	Each	34.33	12	48	0.86
SD3210H	10" x 10" x 1½", Square Plate	Each	48.70	12	48	1.40
SD3212H	12" x 12" x 1¼", Square Plate	Each	41.60	6	24	1.39
SD3214H	14" x 14" x 1¼", Square Plate	Each	29.85	6	12	1.33
SD3216H	16" x 16" x 1¾", Square Plate	Each	41.62	6	12	1.56
SD3314H	96 oz, 13¾" x 9½" x 2⅜", Tray	Each	53.95	6	24	1.97
SD3318H	58 oz, 17½" x 6¾" x 1¾", Tray	Each	40.92	6	24	1.37

# Jazz Dinnerware



Platter • Pasta Bowl • Salad Bowls  
- Crackle Design -



# Jazz Dinnerware

MELAMINE



DM005J

DM006J

DM007J

DM009J

DM010J

DM012J

Item	Description	U/M	Weight Gross lbs	Inner Pack	Master Pack	Cu. Ft.
DM005J	5½" Diameter x ¾" Height, Wide Rim Plate	Dozen	28.13	1	8	0.96
DM006J	6½" Diameter x ¾" Height, Wide Rim Plate	Dozen	37.83	1	8	1.24
DM007J	7⅝" Diameter x ¾" Height, Wide Rim Plate	Dozen	37.41	1	6	1.31
DM009J	9¼" Diameter x ⅞" Height, Wide Rim Plate	Dozen	36.55	1	4	1.17
DM010J	10½" Diameter x ⅞" Height, Wide Rim Plate	Dozen	46.72	1	4	1.56
DM012J	11¾" Diameter x 1" Height, Wide Rim Plate	Dozen	48.90	1	4	1.90



DM5807J



DM5608J



DM5811J



DM5044J

Item	Description	U/M	Weight Gross lbs	Inner Pack	Master Pack	Cu. Ft.
DM5807J	32 oz, 7½" Diameter x 2⅝" Height, Salad Bowl	Dozen	31.75	1	4	1.35
DM5608J	8 oz, 6" Diameter x 1½" Height, Salad Bowl	Dozen	41.01	1	8	1.26
DM5811J	16 oz, 11¼" Diameter x 1⅝" Height, Pasta Bowl	Dozen	42.13	0.50	3	2.12
DM5044J	4 oz, 4¾" Diameter x 1⅜" Height, Salad Bowl	Dozen	23.10	1	8	0.79



DM209J



DM212J



DM213J

Item	Description	U/M	Weight Gross lbs	Inner Pack	Master Pack	Cu. Ft.
DM209J	9½" x 7¼" x ¾", Platter	Dozen	27.56	1	4	0.87
DM212J	12" x 9" x ⅞", Platter	Dozen	44.48	1	4	1.53
DM213J	13½" x 10½" x 1", Platter	Dozen	42.35	0.50	3	1.57



# *Jazz Serving*



Platter • Rectangle Tray •  
 Deep Bowl with Handle • Square Plates  
 - Crackle Design -



# Jazz Serving and Display

MELAMINE



SD2118J



SD2121J

Item	Description	U/M	Weight Gross lbs	Inner Pack	Master Pack	Cu. Ft.
SD2118J	18" x 13 1/2" x 1 1/2", Oval Platter	Each	30.56	2	12	2.03
SD2121J	21" x 15" x 1 3/8", Oval Platter	Each	31.04	2	12	2.68



SD5609J



SD5613J



SD5612J



SD5614J



SD6015J



SD6018J

Item	Description	U/M	Weight Gross lbs	Inner Pack	Master Pack	Cu. Ft.
SD5609J	1 qt/32 oz, 8" Diameter x 2 1/4" Deep, Bowl with 1" Handle	Each	17.24	6	24	1.05
SD5612J	2 qt/64 oz, 11" Diameter x 3" Deep, Bowl with 1 1/4" Handle	Each	37.88	6	24	2.42
SD5613J	3 qt/96 oz, 12 1/4" Diameter x 3 1/4" Deep, Bowl with 1 1/4" Handle	Each	45.30	6	24	2.93
SD5614J	4 qt/128 oz, 12 7/8" Diameter x 3 1/2" Deep, Bowl with 1 1/4" Handle	Each	26.39	6	12	1.72
SD6015J	6 qt/192 oz, 12 1/4" Diameter x 4" Deep, Bowl with 1 3/8" Handle	Each	29.56	6	12	3.06
SD6018J	10 qt/320 oz, 14 3/4" Diameter x 4 3/4" Deep, Bowl with 1 5/8" Handle	Each	42.24	6	12	4.28





# Jazz Serving and Display

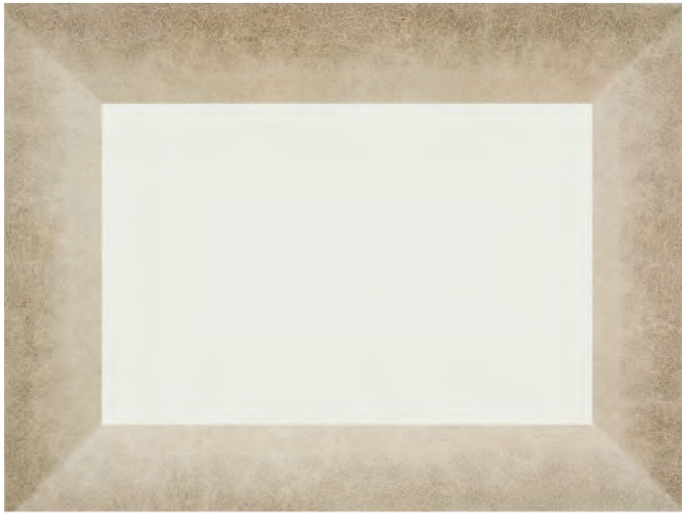

SD3324J

Item	Description	U/M	Weight Gross lbs	Inner Pack	Master Pack	Cu. Ft.
SD3324J	24" x 18" x 1¾", Rectangular Tray	Each	66.32	2	12	4.85



SD3206J



SD3208J



SD3210J



SD3212J



SD3214J



SD3216J



SD3314J



SD3318J

Item	Description	U/M	Weight Gross lbs	Inner Pack	Master Pack	Cu. Ft.
SD3206J	6" x 6" x ¾", Square Plate	Each	19.31	12	48	0.51
SD3208J	8" x 8" x 1", Square Plate	Each	34.33	12	48	0.86
SD3210J	10" x 10" x 1½", Square Plate	Each	48.70	12	48	1.40
SD3212J	12" x 12" x 1¼", Square Plate	Each	41.60	6	24	1.39
SD3214J	14" x 14" x 1¼", Square Plate	Each	29.85	6	12	1.33
SD3216J	16" x 16" x 1¾", Square Plate	Each	41.62	6	12	1.56
SD3314J	96 oz, 13¾" x 9½" x 2¾", Tray	Each	53.95	6	24	1.97
SD3318J	58 oz, 17½" x ¾" x 1¼", Tray	Each	40.92	6	24	1.37

# Black Pearl



Appetizer Platter • Party Plate •  
Mug • All Purpose Bowl • Plates



# Black Pearl

2023



Item	Description	U/M	Weight Gross lbs	Inner Pack	Master Pack	Cu. Ft.
RF1016B	16" Diameter, Round Plate, Black	Each	33.97	2	12	1.86
RF1018B	18" Diameter, Round Plate, Black	Each	27.49	2	8	1.58
RF1020B	20" Diameter, Round Plate, Black	Each	33.16	2	8	1.97
RF1016W	16" Diameter, Round Plate, White	Each	33.97	2	12	1.86
RF1018W	18" Diameter, Round Plate, White	Each	27.49	2	8	1.58
RF1020W	20" Diameter, Round Plate, White	Each	33.16	2	8	1.97



Item	Description	U/M	Weight Gross lbs	Inner Pack	Master Pack	Cu. Ft.
RF2024W	24" x 10", Platter, White	Each	32.01	2	12	1.94
RF2030W	30" x 12", Platter, White	Each	37.85	2	8	2.06
RF2024B	24" x 10", Platter, Black	Each	32.01	2	12	1.94
RF2030B	30" x 12", Platter, Black	Each	37.85	2	8	2.06

MELAMINE

75

# Black Pearl



RF1016BW

RF1018BW

RF1020BW

Item	Description	U/M	Weight Gross lbs	Inner Pack	Master Pack	Cu. Ft.
RF1016BW	16" Diameter, Round Plate, Two Tone (Black and White)	Each	33.97	2	12	1.86
RF1018BW	18" Diameter, Round Plate, Two Tone (Black and White)	Each	27.49	2	8	1.58
RF1020BW	20" Diameter, Round Plate, Two Tone (Black and White)	Each	33.16	2	8	1.97



RF6016BW

7000BL

RF1006BW

RF1010BW

RF1065BW

RF1112B

Item	Description	U/M	Weight Gross lbs	Inner Pack	Master Pack	Cu. Ft.
7000BL	1 oz, 6 <sup>3</sup> / <sub>8</sub> " x 1 <sup>7</sup> / <sub>8</sub> ", Spoon, Black	Dozen	31.86	5	40	2.00
RF1006BW	8 <sup>1</sup> / <sub>2</sub> " Diameter, Round Salad Plate, Two Tone (Black and White)	Each	28.66	12	48	0.95
RF1010BW	10 <sup>1</sup> / <sub>2</sub> " Diameter, Round Dinner Plate, Two Tone (Black and White)	Each	35.78	6	36	1.38
RF1065BW	6 <sup>1</sup> / <sub>2</sub> " Diameter, Round Saucer for RF9475, Two Tone (Black and White)	Each	31.59	12	96	1.20
RF6016BW	14 <sup>1</sup> / <sub>2</sub> " x 14 <sup>1</sup> / <sub>2</sub> ", 3-Section Round Appetizer Tray, Two Tone (Black and White)	Each	39.82	2	16	3.00
RF1112B	73 oz, 12" Diameter x 2" Deep, Salad Platter, Black	Each	39.46	6	24	2.19

**\*\*Soup Spoon is not NSF Certified.\*\***





Item	Description	U/M	Weight Gross lbs	Inner Pack	Master Pack	Cu. Ft.
RF9475BW	23 oz, 4¾" Diameter x 3⅝" Height, Mug, Two Tone (Black and White)	Each	30.00	6	48	3.06
RF2024BW	24" x 10" Platter, Two Tone (Black and White)	Each	32.01	2	12	1.94
RF2030BW	30" x 12", Platter, Two Tone (Black and White)	Each	37.85	2	8	2.06
RF7010B	10½" Diameter, Round Party Plate with Thumb Hold, Black	Each	32.17	6	36	1.46
RF7010W	10½" Diameter, Round Party Plate with Thumb Hold, White	Each	32.17	6	36	1.46



Item	Description	U/M	Weight Gross lbs	Inner Pack	Master Pack	Cu. Ft.
RF5065BW	36 oz, 6½" Diameter, All Purpose Bowl, Two Tone (Black and White)	Each	34.28	6	48	2.17
RF5112BW	176 oz, 11¼" Diameter x 4⅝" Height, Serving Bowl, Two Tone (Black and White)	Each	28.11	3	12	2.47
RF2224BW	22" x 16½", Platter, Two Tone (Black and White)	Each	39.57	2	12	3.17

# Gold Pearl

MELAMINE

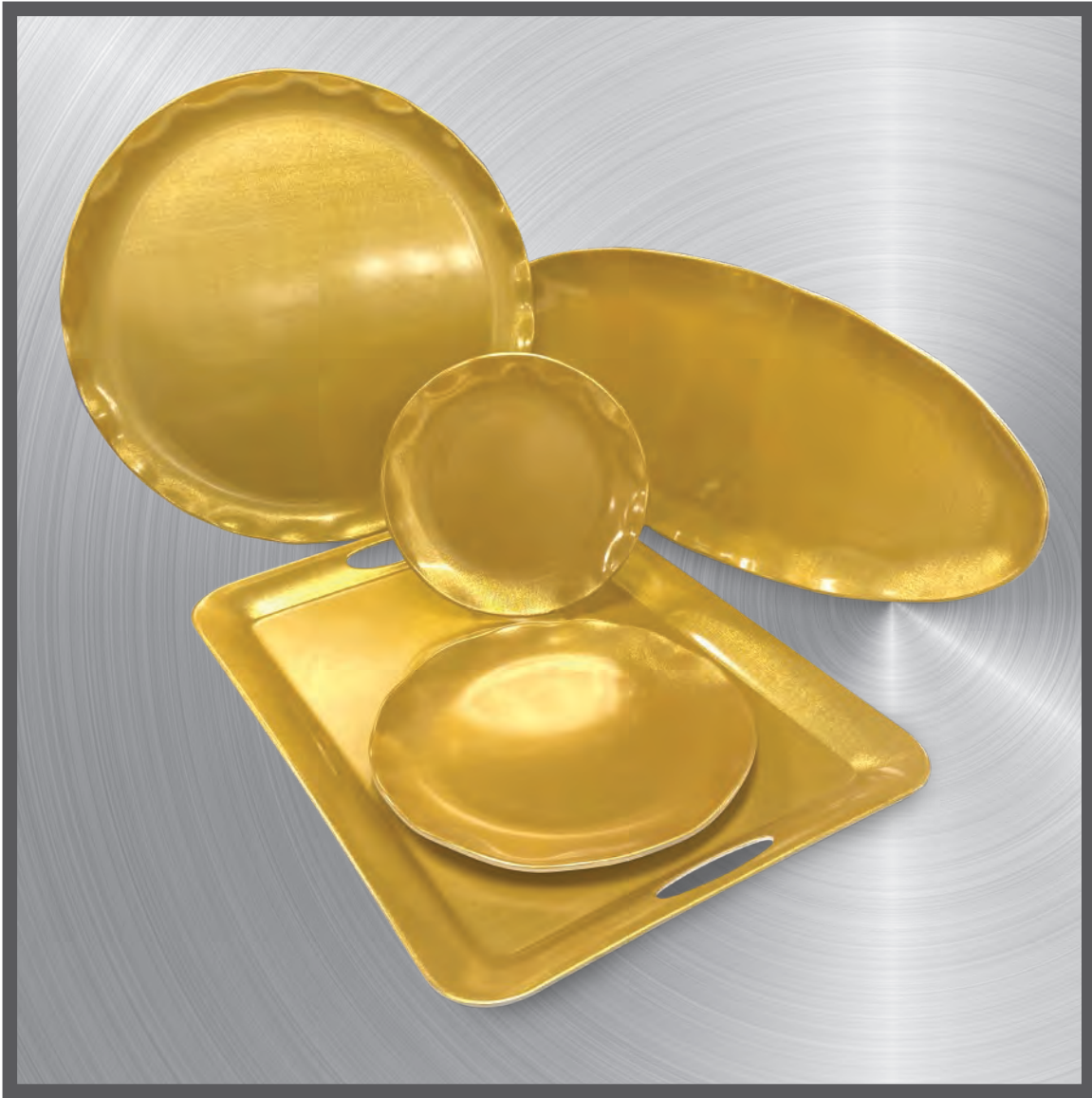

Platter • Rectangular Tray •  
Dinner Plates • 20" Plate





RF1016G



RF1018G

Item	Description	U/M	Weight Gross lbs	Inner Pack	Master Pack	Cu. Ft.
RF1016G	16" Diameter, Round Plate	Each	33.97	2	12	1.86
RF1018G	18" Diameter, Round Plate	Each	27.49	2	8	1.58



RF1006G



RF1010G

Item	Description	U/M	Weight Gross lbs	Inner Pack	Master Pack	Cu. Ft.
RF1006G	8 1/2" Diameter, Round Salad Plate	Each	28.66	12	48	0.95
RF1010G	10 1/2" Diameter, Round Dinner Plate	Each	35.78	6	36	1.38



Front & Back View

Decorated with real fabric texture on one side and white on the reverse side

# Gold Pearl



RF1020G



RF2920G

Item	Description	U/M	Weight Gross lbs	Inner Pack	Master Pack	Cu. Ft.
RF1020G	20" Diameter, Round Plate	Each	33.16	2	8	1.97
RF2024G	24" x 10", Platter	Each	32.01	2	12	1.94



RF2030G



RF2024G

Item	Description	U/M	Weight Gross lbs	Inner Pack	Master Pack	Cu. Ft.
RF2030G	30" x 12", Platter	Each	37.85	2	8	2.06
RF2920G	19½" x 14½", Rectangle Tray	Each	25.88	3	12	1.42

\* Decorated with real fabric texture on one side and white on the reverse side





# Serving Boards



Rectangle Board • Board with Handle  
- Faux Material -



## Serving Boards

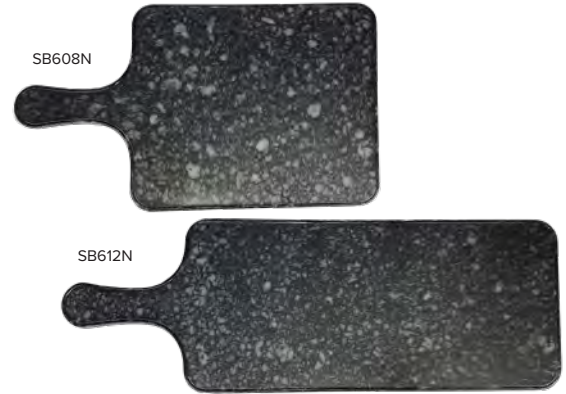
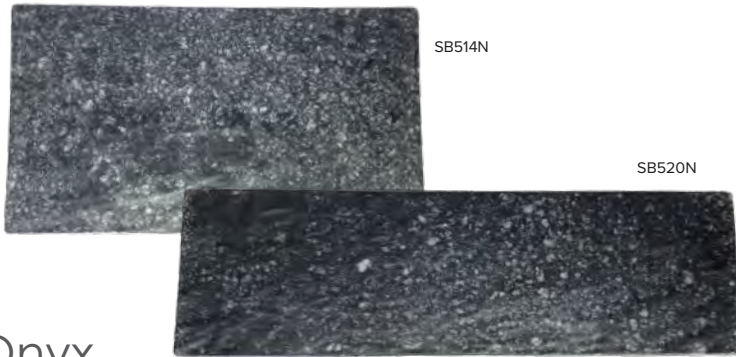

### Onyx

Item	Description	U/M	Weight Gross lbs	Inner Pack	Master Pack	Cu. Ft.
SB514N	14¾" x 8¼" x ¾", Faux Marble	Each	27.50	6	12	0.62
SB520N	20¾" x 6¼" x ¾", Faux Marble	Each	28.50	6	12	0.69
SB608N	8⅞" x 7½" with 4⅞" Handle, Faux Marble	Each	21.34	6	24	1.03
SB612N	12⅞" x 5⅞" with 4⅞" Handle, Faux Marble	Each	23.69	6	24	1.08



### Sequoia

Item	Description	U/M	Weight Gross lbs	Inner Pack	Master Pack	Cu. Ft.
SB514S	14¾" x 8¼" x ¾", Faux Wood	Each	27.50	6	12	0.62
SB520S	20¾" x 6¼" x ¾", Faux Wood	Each	28.50	6	12	0.69
SB608S	8⅞" x 7½" with 4⅞" Handle, Faux Wood	Each	21.34	6	24	1.03
SB612S	12⅞" x 5⅞" with 4⅞" Handle, Faux Wood	Each	23.69	6	24	1.08

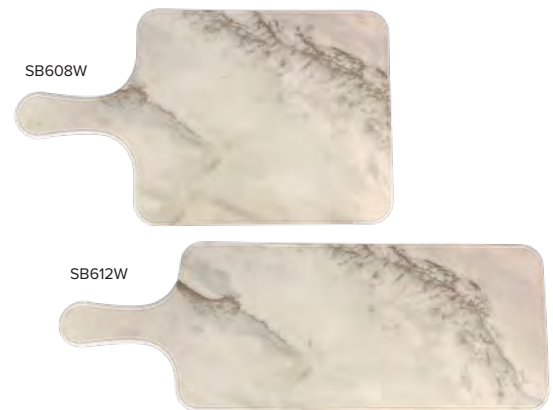

### White Shadow

Item	Description	U/M	Weight Gross lbs	Inner Pack	Master Pack	Cu. Ft.
SB514W	14¾" x 8¼" x ¾", Faux Marble	Each	27.50	6	12	0.62
SB520W	20¾" x 6¼" x ¾", Faux Marble	Each	28.50	6	12	0.69
SB608W	8⅞" x 7½" with 4⅞" Handle, Faux Marble	Each	21.34	6	24	1.03
SB612W	12⅞" x 5⅞" with 4⅞" Handle, Faux Marble	Each	23.69	6	24	1.08

# Passion Pearl



Compartment Tray • Square  
Bowl • Round Square Bowls •  
Square Plate



# Passion Pearl



PS3008V



PS3010V



PS3014V

Item	Description	U/M	Weight Gross lbs	Inner Pack	Master Pack	Cu. Ft.
PS3008V	8¼" x 8¼", Round Square Plate	Each	27.12	12	48	0.97
PS3010V	11" x 11", Round Square Plate	Each	44.75	12	48	1.75
PS3014V	14" x 14", Round Square Plate	Each	54.89	6	24	1.58



PS3208V



PS3211V



PS3214V



PS5103V



PS5104V



PS1515V

Item	Description	U/M	Weight Gross lbs	Inner Pack	Master Pack	Cu. Ft.
PS3208V	8¼" x 8¼" x ¾", Square Plate	Each	45.86	12	72	1.28
PS3211V	10¼" x 10¼" x 1", Square Plate	Each	44.31	12	48	1.50
PS3214V	13¾" x 13¾" x 1½", Square Plate	Each	61.73	6	36	2.42
PS5103V	28 oz, 15" x 6¼" x 1¾", Rectangular 3-Section Tray	Each	38.58	6	36	1.29
PS5104V	60 oz, 13½" x 13½" x 1¾", Square 4-Section Tray	Each	49.38	6	36	2.03
PS1515V	15" x 15" x 1¾", Chip And Dip Platter	Each	27.12	6	12	1.80



PS3103V



PS3105V



PS3106V



PS3110V



PS3111V

Item	Description	U/M	Weight Gross lbs	Inner Pack	Master Pack	Cu. Ft.
PS3103V	5 oz, 3½" x 3½" x 1½", Round Square Bowl	Each	11.90	12	72	0.55
PS3105V	14 oz, 4¾" x 4¾" x 2½", Round Square Bowl	Each	48.72	12	144	2.20
PS3106V	20 oz, 5½" x 5½" x 2¾", Round Square Bowl	Each	42.77	12	72	1.59
PS3110V	96 oz, 11" Diameter x 3 ½" Deep, Bowl	Each	35.27	4	16	1.88
PS3111V	128 oz, 11" x 11" x 3½", Round Square Bowl	Each	51.81	6	24	2.74



PS5004V



PS5005V



PS5006V



PS5008V



PS5010V



PS9475V



PS3204V



PS6013V

Item	Description	U/M	Weight Gross lbs	Inner Pack	Master Pack	Cu. Ft.
PS5004V	8 oz, 4" x 4" x 2", Square Bowl	Each	22.99	12	144	0.70
PS5005V	11 oz, 4¾" x 4¾" x 2", Square Bowl	Each	32.63	12	144	1.10
PS5006V	23 oz, 6" x 6" x 2½", Square Bowl	Each	48.50	12	144	1.85
PS5008V	52 oz, 8" x 8" x 2½", Square Bowl	Each	33.26	12	48	1.11
PS5010V	80 oz, 10" x 10" x ½", Square Bowl	Each	41.16	12	36	1.36
PS9475V	23 oz, 4¾" Diameter x 3⅝" Height, Mug	Each	29.98	6	48	3.09
PS3204V	4" x 4", Square Plate	Each	33.64	12	216	0.89
PS6013V	70 oz, 13" Diameter x 4⅞" Deep, Salad Bowl	Each	35.05	4	16	2.62

# Passion Red

MELAMINE



Square Bowl • Round Square  
Plate • Square Plates • Mug





PS3008RD



PS3010RD



PS3014RD

Item	Description	U/M	Weight Gross lbs	Inner Pack	Master Pack	Cu. Ft.
PS3008RD	8¼" x 8¼", Round Square Plate	Each	27.12	12	48	0.97
PS3010RD	11" x 11", Round Square Plate	Each	44.75	12	48	1.75
PS3014RD	14" x 14", Round Square Plate	Each	54.89	6	24	1.58



PS3208RD



PS3211RD



PS3214RD

Item	Description	U/M	Weight Gross lbs	Inner Pack	Master Pack	Cu. Ft.
PS3208RD	8¼" x 8¼" x 7/8", Square Plate	Each	45.86	12	72	1.28
PS3211RD	10¼" x 10¼" x 1", Square Plate	Each	44.31	12	48	1.50
PS3214RD	13¾" x 13¾" x 1 1/8", Square Plate	Each	61.73	6	36	2.42
PS5103RD	28 oz, 15" x 6¼" x 1 3/8", Rectangular 3-Section Tray	Each	38.58	6	36	1.29
PS5104RD	60 oz, 13½" x 1 ½" x 1 3/8", Square 4-Section Tray	Each	49.38	6	36	2.03
PS1515RD	15" x 15" x 1 3/4", Chip And Dip Platter	Each	27.12	6	12	1.80



PS5103RD



PS5104RD



PS1515RD

# Passion Red

MELAMINE



PS3103RD



PS3105RD



PS3106RD



PS3110RD



PS3111RD

Item	Description	U/M	Weight Gross lbs	Inner Pack	Master Pack	Cu. Ft.
PS3103RD	5 oz, 3½" x 3½" x 1½", Round Square Bowl	Each	11.90	12	72	0.55
PS3105RD	14 oz, 4¾" x 4¾" x 2½", Round Square Bowl	Each	48.72	12	144	2.20
PS3106RD	20 oz, 5½" x 5½" x 2¾", Round Square Bowl	Each	42.77	12	72	1.59
PS3110RD	96 oz, 11" Diameter x 3½" Deep, Bowl	Each	35.27	4	16	1.88
PS3111RD	128 oz, 11" x 11" x 3½", Round Square Bowl	Each	51.81	6	24	2.74



PS5004RD



PS5005RD



PS5006RD



PS5008RD



PS5010RD



PS9475RD



PS3204RD



PS6013RD

Item	Description	U/M	Weight Gross lbs	Inner Pack	Master Pack	Cu. Ft.
PS5004RD	8 oz, 4" x 4" x 2", Square Bowl	Each	22.99	12	144	0.70
PS5005RD	11 oz, 4¾" x 4¾" x 2", Square Bowl	Each	32.63	12	144	1.10
PS5006RD	23 oz, 6" x 6" x 2½", Square Bowl	Each	48.50	12	144	1.85
PS5008RD	52 oz, 8" x 8" x 2½", Square Bowl	Each	33.26	12	48	1.11
PS5010RD	80 oz, 10" x 10" x 2½", Square Bowl	Each	41.16	12	36	1.36
PS9475RD	23 oz, 4¾" Diameter x 3⅝" Height, Mug	Each	29.98	6	48	3.09
PS3204RD	4" x 4", Square Plate	Each	33.64	12	216	0.89
PS6013RD	70 oz, 13" Diameter x 4⅞" Deep, Salad Bowl	Each	35.05	4	16	2.62





# Passion White



Round Square Plate • Square Plate • Square Bowl • Mug



# Passion White



PS3008W



PS3010W



PS3014W

Item	Description	U/M	Weight Gross lbs	Inner Pack	Master Pack	Cu. Ft.
PS3008W	8¼" x 8¼", Round Square Plate	Each	27.12	12	48	0.97
PS3010W	11" x 11", Round Square Plate	Each	44.75	12	48	1.75
PS3014W	14" x 14", Round Square Plate	Each	54.89	6	24	1.58



PS3208W



PS3211W



PS3214W



PS5103W



PS5104W



PS1515W

Item	Description	U/M	Weight Gross lbs	Inner Pack	Master Pack	Cu. Ft.
PS3208W	8¼" x 8¼" x 7⁄8", Square Plate	Each	45.86	12	72	1.28
PS3211W	10¼" x 10¼" x 1", Square Plate	Each	44.31	12	48	1.50
PS3214W	13¾" x 13¾" x 1½", Square Plate	Each	61.73	6	36	2.42
PS5103W	28 oz, 15" x 6¼" x 1 3⁄8", Rectangular 3-Section Tray	Each	38.58	6	36	1.29
PS5104W	60 oz, 13½" x 13½" x 1 3⁄8", Square 4-Section Tray	Each	49.38	6	36	2.03
PS1515W	15" x 15" x 1¾", Chip And Dip Platter	Each	27.12	6	12	1.80



PS3103W



PS3105W



PS3106W



PS3110W



PS3111W

Item	Description	U/M	Weight Gross lbs	Inner Pack	Master Pack	Cu. Ft.
PS3103W	5 oz, 3½" x 3½" x 1½", Round Square Bowl	Each	11.90	12	72	0.55
PS3105W	14 oz, 4¾" x 4¾" x 2½", Round Square Bowl	Each	48.72	12	144	2.20
PS3106W	20 oz, 5½" x 5½" x 2¾", Round Square Bowl	Each	42.77	12	72	1.59
PS3110W	96 oz, 11" Diameter x 3½" Deep, Bowl	Each	35.27	4	16	1.88
PS3111W	128 oz, 11" x 11" x 3½", Round Square Bowl	Each	51.81	6	24	2.74



PS5004W



PS5005W



PS5006W



PS5008W



PS5010W



PS9475W



PS3204W



PS6013W

Item	Description	U/M	Weight Gross lbs	Inner Pack	Master Pack	Cu. Ft.
PS5004W	8 oz, 4" x 4" x 2", Square Bowl	Each	22.99	12	144	0.70
PS5005W	11 oz, 4¾" x 4¾" x 2", Square Bowl	Each	32.63	12	144	1.10
PS5006W	23 oz, 6" x 6" x 2½", Square Bowl	Each	48.50	12	144	1.85
PS5008W	52 oz, 8" x 8" x 2½", Square Bowl	Each	33.26	12	48	1.11
PS5010W	80 oz, 10" x 10" x 2½", Square Bowl	Each	41.16	12	36	1.36
PS9475W	23 oz, 4¾" Diameter x 3⅝" Height, Mug	Each	29.98	6	48	3.09
PS3204W	4" x 4", Square Plate	Each	33.64	12	216	0.89
PS6013W	70 oz, 13" Diameter x 4⅞" Deep, Salad Bowl	Each	35.05	4	16	2.62

# Blue Dragon

MELAMINE



Plate • Deep Platter • Lid • Bowl  
• Soup Spoon • Tea Cup



# Blue Dragon

2023

MELAMINE

93



Item	Description	U/M	Weight Gross lbs	Inner Pack	Master Pack	Cu. Ft.
1006DL	6" Diameter x ½" Height, Round Plate	Dozen	60.63	1	24	1.96
1007DL	6⅞" Diameter x ¾" Height, Round Plate	Dozen	46.03	1	16	1.69
1008DL	7⅞" Diameter x ⅝" Height, Round Plate	Dozen	55.12	1	12	1.86
1009DL	9⅞" Diameter x ¾" Height, Round Plate	Dozen	49.71	1	8	1.66
1010DL	10⅝" Diameter x ⅞" Height, Round Plate	Dozen	39.48	1	6	1.69
1012DL	11¾" Diameter x ⅞" Height, Round Plate	Dozen	44.25	1	4	1.62
1013DL	12⅝" Diameter x 1" Height, Round Plate	Dozen	43.21	0.50	3	1.77
1014DL	14⅞" Diameter x 1⅝" Height, Round Plate	Dozen	51.81	0.50	3	2.22
1016DL	15½" Diameter x 1¼" Height, Round Plate	Dozen	48.50	0.50	2	2.62
1015DL	14⅝" Diameter x 1¾" Height, Narrow Rim Round Plate	Dozen	48.50	0.50	2	3.21



Item	Description	U/M	Weight Gross lbs	Inner Pack	Master Pack	Cu.Ft
1106DL	3 oz, 6" Diameter x 1" Height, Soup Plate	Dozen	48.50	1	18	1.52
1107DL	5 oz, 7" Diameter x 1" Height, Soup Plate	Dozen	52.91	1	16	1.89
1108DL	7 oz, 7⅞" Diameter x 1" Height, Soup Plate	Dozen	50.04	1	12	1.92
1109DL	10 oz, 9¼" Diameter x 1¼" Height, Soup Plate	Dozen	68.12	1	10	2.49
1110DL	12 oz, 10⅝" Diameter x 1¼" Height, Soup Plate	Dozen	65.70	1	8	2.41

# Blue Dragon

MELAMINE



2109DL



2110DL



2112DL



2113DL



2114DL

Item	Description	U/M	Weight Gross lbs	Inner Pack	Master Pack	Cu. Ft.
2109DL	7 oz, 9" x 6 <sup>3</sup> / <sub>4</sub> " x 1 <sup>1</sup> / <sub>8</sub> ", Deep Platter	Dozen	53.79	1	10	1.81
2110DL	9 oz, 10" x 7 <sup>1</sup> / <sub>2</sub> " x 1 <sup>1</sup> / <sub>8</sub> ", Deep Platter	Dozen	51.15	1	8	1.76
2112DL	16 oz, 12" x 9" x 1 <sup>5</sup> / <sub>8</sub> ", Deep Platter	Dozen	58.30	1	6	2.49
2113DL	24 oz, 13" x 9 <sup>3</sup> / <sub>4</sub> " x 1 <sup>5</sup> / <sub>8</sub> ", Deep Platter	Dozen	49.60	1	4	1.97
2114DL	28 oz, 14 <sup>1</sup> / <sub>8</sub> " x 10 <sup>5</sup> / <sub>8</sub> " x 1 <sup>3</sup> / <sub>4</sub> ", Deep Platter	Dozen	53.57	1	4	2.37



2008DL



2009DL



2010DL



2012DL



2014DL



2016DL

Item	Description	U/M	Weight Gross lbs	Inner Pack	Master Pack	Cu. Ft.
2008DL	8" x 6" x 5 <sup>5</sup> / <sub>8</sub> ", Platter	Dozen	54.01	1	16	2.65
2009DL	9" x 6 <sup>5</sup> / <sub>8</sub> " x 3 <sup>4</sup> / <sub>4</sub> ", Platter	Dozen	41.23	1	10	1.84
2010DL	9 <sup>7</sup> / <sub>8</sub> " x 7 <sup>1</sup> / <sub>4</sub> " x 3 <sup>4</sup> / <sub>4</sub> ", Platter	Dozen	50.86	1	8	1.90
2012DL	12" x 8 <sup>5</sup> / <sub>8</sub> " x 7 <sup>8</sup> / <sub>8</sub> ", Platter	Dozen	48.50	1	6	2.06
2014DL	14" x 10" x 1 <sup>1</sup> / <sub>8</sub> ", Platter	Dozen	34.94	0.50	3	2.18
2016DL	16" x 11 <sup>5</sup> / <sub>8</sub> " x 1 <sup>1</sup> / <sub>4</sub> ", Platter	Dozen	51.81	0.50	3	2.13



5060DL



5065DL



5070DL



5075DL



5085DL



5095DL

Item	Description	U/M	Weight Gross lbs	Inner Pack	Master Pack	Cu. Ft.
5060DL	22 oz, 6 <sup>7</sup> / <sub>8</sub> " Diameter x 2 <sup>1</sup> / <sub>4</sub> " Height, Rimless Bowl	Dozen	37.92	1	8	2.07
5065DL	32 oz, 7 <sup>1</sup> / <sub>2</sub> " Diameter x 2 <sup>1</sup> / <sub>2</sub> " Height, Rimless Bowl	Dozen	43.98	1	8	2.59
5070DL	36 oz, 8" Diameter x 2 <sup>5</sup> / <sub>8</sub> " Height, Rimless Bowl	Dozen	41.45	1	6	2.10
5075DL	52 oz, 8 <sup>3</sup> / <sub>4</sub> " Diameter x 2 <sup>7</sup> / <sub>8</sub> " Height, Rimless Bowl	Dozen	47.18	1	6	2.43
5085DL	70 oz, 9 <sup>3</sup> / <sub>4</sub> " Diameter x 3 <sup>1</sup> / <sub>4</sub> " Height, Rimless Bowl	Dozen	48.06	0.50	4	3.24
5095DL	96 oz, 11" Diameter x 3 <sup>3</sup> / <sub>4</sub> " Height, Rimless Bowl	Dozen	51.15	0.50	3	3.66



5206DL



5207DL



5208DL



5265DL



5275DL



5285DL

Item	Description	U/M	Weight Gross lbs	Inner Pack	Master Pack	Cu. Ft.
5206DL	25 oz, 5 <sup>7</sup> / <sub>8</sub> " Diameter x 2 <sup>7</sup> / <sub>8</sub> " Height, Rice Bowl	Dozen	26.46	1	6	1.35
5207DL	39 oz, 7" Diameter x 3 <sup>1</sup> / <sub>4</sub> " Height, Rice Bowl	Dozen	37.15	1	6	2.11
5208DL	56 oz, 8" Diameter x 3 <sup>1</sup> / <sub>2</sub> " Height, Rice Bowl	Dozen	41.29	1	6	2.50
5265DL	25 oz, 6 <sup>1</sup> / <sub>4</sub> " Diameter x 2 <sup>3</sup> / <sub>4</sub> " Height, Scalloped Bowl	Dozen	39.68	1	8	1.92
5275DL	34 oz, 7 <sup>1</sup> / <sub>4</sub> " Diameter x 3" Height, Scalloped Bowl	Dozen	40.79	1	6	1.82
5285DL	53 oz, 8 <sup>1</sup> / <sub>4</sub> " Diameter x 3 <sup>1</sup> / <sub>2</sub> " Height, Scalloped Bowl	Dozen	60.63	0.50	6	3.60

# Blue Dragon

MELAMINE



5106DL



5107DL



5108DL



5306DL



5307DL



5308DL



5309DL

Item	Description	U/M	Weight Gross lbs	Inner Pack	Master Pack	Cu.Ft
5106DL	15 oz, 6" Diameter x 2" Height, Deep Bowl	Dozen	39.24	1	12	1.76
5107DL	24 oz, 7" Diameter x 2¼" Height, Deep Bowl	Dozen	39.68	1	8	1.46
5108DL	34 oz, 8" Diameter x 2½" Height, Deep Bowl	Dozen	50.71	1	8	2.47
5306DL	21 oz, 6" Diameter x 2½" Height, Swirl Bowl	Dozen	29.10	1	6	1.29
5307DL	32 oz, 6⅞" Diameter x 2¾" Height, Swirl Bowl	Dozen	37.48	1	6	1.58
5308DL	48 oz, 8" Diameter x 3⅛" Height, Swirl Bowl	Dozen	51.15	0.50	6	2.94
5309DL	72 oz, 9" Diameter x 3½" Height, Swirl Bowl	Dozen	37.92	0.50	3	2.16



3201DL (Bowl)  
(Lid & Bowl are sold separately)



3201CDL (LID)



8010DL



8011DL

Item	Description	U/M	Weight Gross lbs	Inner Pack	Master Pack	Cu.Ft
3201DL	20 oz, 5¾" Diameter x 3" Height, Noodle Bowl (Lid Sold Separately)	Dozen	29.76	1	6	1.19
3201CDL	5 ¼" Diameter, Lid only for 3201DL	Dozen	14.33	1	6	0.97
8010DL	75 oz, 10" Diameter x 3⅛" Height, Serving Bowl with Lid	Each	23.15	1	12	3.15
8011DL	80 oz, 11" Diameter x 3¼" Height, Serving Bowl with Lid	Each	29.76	1	12	3.60





3004DL



3006DL



3008DL



9152DL

**3008TW • Rice Bowl**  
Enlarged to show detail



Item	Description	U/M	Weight Gross lbs	Inner Pack	Master Pack	Cu.Ft
3004DL	12 oz, 4 $\frac{1}{8}$ " Diameter x 2 $\frac{3}{8}$ " Height, Rice Bowl	Dozen	54.54	1	18	2.63
3006DL	9 oz, 4 $\frac{3}{8}$ " Diameter x 2 $\frac{1}{8}$ " Height, Rice Bowl	Dozen	52.36	1	24	2.60
3008DL	6 oz, 3 $\frac{3}{4}$ " Diameter x 2" Height, Rice Bowl	Dozen	42.99	2	24	1.79
9152DL	5 oz, 3 $\frac{1}{8}$ " Diameter x 2 $\frac{1}{8}$ " Height, Tea Cup	Dozen	54.67	1	30	2.94



7003DL



7005DL

**7005DL • Rice Ladle**  
Enlarged to show detail

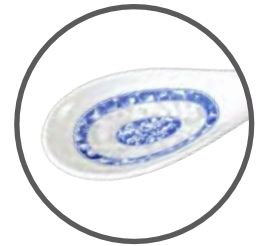

Item	Description	U/M	Weight Gross lbs	Inner Pack	Master Pack	Cu.Ft
7003DL	$\frac{3}{4}$ oz, 5 $\frac{3}{4}$ " x 1 $\frac{3}{4}$ ", Won Ton Soup Spoon	Dozen	52.58	5	100	2.26
7005DL	1 $\frac{1}{2}$ oz, 8 $\frac{1}{4}$ " x 2 $\frac{3}{4}$ ", Rice Ladle	Dozen	48.50	2	30	2.38



1003DL



102.8DL



1101DL



1004DL



1102DL

**1101DL • Sauce Dish**  
Enlarged to show detail



Item	Description	U/M	Weight Gross lbs	Inner Pack	Master Pack	Cu.Ft
1003DL	3 oz, 3 $\frac{7}{8}$ " Diameter x $\frac{3}{4}$ " Height, Sauce Dish	Dozen	54.01	5	50	2.04
102.8DL	2 oz, 3 $\frac{1}{2}$ " Diameter x $\frac{5}{8}$ " Height, Sauce Dish	Dozen	64.77	5	80	1.89
1101DL	1 oz, 2 $\frac{3}{4}$ " Diameter x $\frac{5}{8}$ " Height, Sauce Dish	Dozen	42.97	5	80	1.22
1004DL	4 oz, 4 $\frac{1}{2}$ " Diameter x $\frac{3}{4}$ " Height, Round Plate	Dozen	26.01	1	12	0.90
1102DL	2 oz, 3 $\frac{3}{8}$ " x 2 $\frac{3}{4}$ " x $\frac{1}{2}$ ", Twin Sauce Dish	Dozen	41.89	2	40	1.65

**\*\*Rice Ladle and Soup Spoon are not NSF Certified.\*\***

# Imperial

MELAMINE



Plate • Platter Soup Plate • Rice  
Bowl • Sauce Dish • Soup Spoon





1006TW

1007TW

1008TW

1009TW

1010TW

1012TW



1013TW

1014TW

1016TW

1015TW

Item	Description	U/M	Weight Gross lbs	Inner Pack	Master Pack	Cu. Ft.
1006TW	6" Diameter x 1/2" Height, Round Plate	Dozen	60.63	1	24	1.96
1007TW	6 7/8" Diameter x 3/4" Height, Round Plate	Dozen	45.98	1	16	1.69
1008TW	7 7/8" Diameter x 5/8" Height, Round Plate	Dozen	55.12	1	12	1.86
1009TW	9 1/8" Diameter x 3/4" Height, Round Plate	Dozen	49.71	1	8	1.66
1010TW	10 3/8" Diameter x 7/8" Height, Round Plate	Dozen	39.48	1	6	1.69
1012TW	11 3/4" Diameter x 7/8" Height, Round Plate	Dozen	44.25	1	4	1.62
1013TW	12 5/8" Diameter x 1" Height, Round Plate	Dozen	43.21	0.50	3	1.77
1014TW	14 1/8" Diameter x 1 1/8" Height, Round Plate	Dozen	51.81	0.50	3	2.22
1016TW	15 1/2" Diameter x 1 1/4" Height, Round Plate	Dozen	48.50	0.50	2	2.62
1015TW	14 3/8" Diameter x 1 3/4" Height, Narrow Rim Round Plate	Dozen	48.50	0.50	2	3.21



1106TW

1107TW

1108TW

1109TW

1110TW

Item	Description	U/M	Weight Gross lbs	Inner Pack	Master Pack	Cu. Ft.
1106TW	3 oz, 6" Diameter x 1" Height, Soup Plate	Dozen	48.50	1	18	1.52
1107TW	5 oz, 7" Diameter x 1" Height, Soup Plate	Dozen	52.91	1	16	1.89
1108TW	7 oz, 7 7/8" Diameter x 1" Height, Soup Plate	Dozen	50.04	1	12	1.92
1109TW	10 oz, 9 1/4" Diameter x 1 1/4" Height, Soup Plate	Dozen	68.12	1	10	2.49
1110TW	12 oz, 10 3/8" Diameter x 1 1/4" Height, Soup Plate	Dozen	65.70	1	8	2.41

# Imperial

MELAMINE



2109TW



2110TW



2112TW



2113TW



2114TW

Item	Description	U/M	Weight Gross lbs	Inner Pack	Master Pack	Cu. Ft.
2109TW	7 oz, 9" x 6 $\frac{3}{4}$ " x 1 $\frac{1}{8}$ ", Deep Platter	Dozen	53.79	1	10	1.81
2110TW	9 oz, 10" x 7 $\frac{1}{2}$ " x 1 $\frac{1}{8}$ ", Deep Platter	Dozen	51.15	1	8	1.76
2112TW	16 oz, 12" x 9" x 1 $\frac{5}{8}$ ", Deep Platter	Dozen	58.30	1	6	2.49
2113TW	24 oz, 13" x 9 $\frac{3}{4}$ " x 1 $\frac{5}{8}$ ", Deep Platter	Dozen	49.60	1	4	1.97
2114TW	28 oz, 14 $\frac{1}{8}$ " x 10 $\frac{5}{8}$ " x 1 $\frac{3}{4}$ ", Deep Platter	Dozen	53.57	1	4	2.37



2008TW



2009TW



2010TW



2012TW



2014TW



2016TW

Item	Description	U/M	Weight Gross lbs	Inner Pack	Master Pack	Cu. Ft.
2008TW	8" x 6" x $\frac{5}{8}$ ", Platter	Dozen	54.01	1	16	2.65
2009TW	9" x 6 $\frac{5}{8}$ " x $\frac{3}{4}$ ", Platter	Dozen	41.23	1	10	1.84
2010TW	9 $\frac{7}{8}$ " x 7 $\frac{1}{4}$ " x $\frac{3}{4}$ ", Platter	Dozen	50.86	1	8	1.90
2012TW	12" x 8 $\frac{5}{8}$ " x $\frac{7}{8}$ ", Platter	Dozen	48.50	1	6	2.06
2014TW	14" x 10" x 1 $\frac{1}{8}$ ", Platter	Dozen	34.94	0.50	3	2.18
2016TW	16" x 11 $\frac{5}{8}$ " x 1 $\frac{1}{4}$ ", Platter	Dozen	51.81	0.50	3	2.13



5265TW



5275TW



5285TW



5206TW



5207TW



5208TW

Item	Description	U/M	Weight Gross lbs	Inner Pack	Master Pack	Cu. Ft.
5265TW	25 oz, 6¼" Diameter x 2¾" Height, Scalloped Bowl	Dozen	39.68	1	8	1.92
5275TW	34 oz, 7¼" Diameter x 3" Height, Scalloped Bowl	Dozen	40.79	1	6	1.82
5285TW	53 oz, 8¼" Diameter x 3½" Height, Scalloped Bowl	Dozen	60.63	0.50	6	3.60
5206TW	25 oz, 5⅞" Diameter x 2⅞" Height, Rice Bowl	Dozen	26.46	1	6	1.35
5207TW	39 oz, 7" Diameter x 3¼" Height, Rice Bowl	Dozen	37.15	1	6	2.11
5208TW	56 oz, 8" Diameter x 3½" Height, Rice Bowl	Dozen	41.29	1	6	2.50



5306TW



5307TW



5308TW



5309TW



5106TW



5107TW



5108TW

Item	Description	U/M	Weight Gross lbs	Inner Pack	Master Pack	Cu. Ft.
5306TW	21 oz, 6" Diameter x 2½" Height, Swirl Bowl	Dozen	29.10	1	6	1.29
5307TW	32 oz, 6⅞" Diameter x 2¾" Height, Swirl Bowl	Dozen	37.48	1	6	1.58
5308TW	48 oz, 8" Diameter x 3⅞" Height, Swirl Bowl	Dozen	51.15	0.50	6	2.94
5309TW	72 oz, 9" Diameter x 3½" Height, Swirl Bowl	Dozen	37.92	0.50	3	2.16
5106TW	15 oz, 6" Diameter x 2" Height, Bowl	Dozen	39.24	1	12	1.76
5107TW	24 oz, 7" Diameter x 2¼" Height, Bowl	Dozen	39.68	1	8	1.46
5108TW	34 oz, 8" Diameter x 2½" Height, Bowl	Dozen	50.71	1	8	2.47

# Imperial



**3008TW • Rice Bowl**  
Enlarged to show detail



3004TW



3006TW



3008TW

Item	Description	U/M	Weight Gross lbs	Inner Pack	Master Pack	Cu. Ft.
3004TW	12 oz, 4 $\frac{7}{8}$ " Diameter x 2 $\frac{3}{8}$ " Height, Rice Bowl	Dozen	54.54	1	18	2.63
3006TW	9 oz, 4 $\frac{3}{4}$ " Diameter x 2 $\frac{1}{8}$ " Height, Rice Bowl	Dozen	52.36	1	24	2.60
3008TW	6 oz, 3 $\frac{3}{4}$ " Diameter x 2" Height, Rice Bowl	Dozen	42.99	2	24	1.79



**7005R • Rice Ladle**  
Enlarged to show detail



7100TW



7200TW



7003W

Item	Description	U/M	Weight Gross lbs	Inner Pack	Master Pack	Cu. Ft.
7003W	$\frac{3}{4}$ oz, 5 $\frac{3}{4}$ " x 1 $\frac{3}{4}$ ", Won Ton Soup Spoon	Dozen	52.58	5	100	2.26
7100TW	1 oz, 6 $\frac{1}{4}$ " x 1 $\frac{3}{4}$ ", Soup Spoon	Dozen	45.48	5	60	2.21
7200TW	0.6 oz, 6 $\frac{3}{8}$ " x 1 $\frac{3}{4}$ ", Soup Spoon	Dozen	37.93	5	60	1.74



**1002TW • Twin Sauce Dish**  
Enlarged to show detail



1003TW



102.8TW



1101TW



1004TW



1102TW

Item	Description	U/M	Weight Gross lbs	Inner Pack	Master Pack	Cu. Ft.
1003TW	3 oz, 3 $\frac{7}{8}$ " Diameter x $\frac{3}{4}$ " Height, Sauce Dish	Dozen	54.01	5	50	2.04
102.8TW	2 oz, 3 $\frac{1}{2}$ " Diameter x $\frac{3}{8}$ " Height, Sauce Dish	Dozen	64.77	5	80	1.89
1101TW	1 oz, 2 $\frac{3}{4}$ " Diameter x $\frac{5}{8}$ " Height, Sauce Dish	Dozen	42.97	5	80	1.22
1004TW	4 oz, 4 $\frac{1}{2}$ " Diameter x $\frac{3}{4}$ " Height, Round Plate	Dozen	26.01	1	12	0.90
1102TW	2 oz, 3 $\frac{3}{8}$ " x 2 $\frac{3}{4}$ " x $\frac{1}{2}$ ", Twin Sauce Dish	Dozen	41.89	2	40	1.65

**\*\*Soup Spoons are not NSF Certified.\*\***



# Longevity



Platter • Soup Plate • Soup Spoon  
• Rice Bowl • Twin Sauce Dish



# Longevity

MELAMINE



1006TR

1007TR

1008TR

1009TR

1010TR

1012TR



1013TR

1014TR

1016TR

1015TR

Item	Description	U/M	Weight Gross lbs	Inner Pack	Master Pack	Cu. Ft.
1006TR	6" Diameter x 1/2" Height, Round Plate	Dozen	60.63	1	24	1.96
1007TR	6 7/8" Diameter x 3/4" Height, Round Plate	Dozen	46.03	1	16	1.69
1008TR	7 7/8" Diameter x 5/8" Height, Round Plate	Dozen	55.12	1	12	1.86
1009TR	9 1/8" Diameter x 3/4" Height, Round Plate	Dozen	49.71	1	8	1.66
1010TR	10 3/8" Diameter x 7/8" Height, Round Plate	Dozen	39.48	1	6	1.69
1012TR	11 3/4" Diameter x 7/8" Height, Round Plate	Dozen	44.25	1	4	1.62
1013TR	12 5/8" Diameter x 1" Height, Round Plate	Dozen	43.21	0.50	3	1.77
1014TR	14 1/8" Diameter x 1 1/8" Height, Round Plate	Dozen	51.81	0.50	3	2.22
1016TR	15 1/2" Diameter x 1 1/4" Height, Round Plate	Dozen	48.50	0.50	2	2.62
1015TR	14 3/8" Diameter x 1 3/4" Height, Narrow Round Plate	Dozen	48.50	0.50	2	3.21



1106TR

1107TR

1108TR

1109TR

1110TR

Item	Description	U/M	Weight Gross lbs	Inner Pack	Master Pack	Cu. Ft.
1106TR	3 oz, 6" Diameter x 1" Height, Soup Plate	Dozen	48.50	1	18	1.52
1107TR	5 oz, 7" Diameter x 1" Height, Soup Plate	Dozen	52.91	1	16	1.89
1108TR	7 oz, 7 7/8" Diameter x 1" Height, Soup Plate	Dozen	50.04	1	12	1.92
1109TR	10 oz, 9 1/4" Diameter x 1 1/4" Height, Soup Plate	Dozen	68.12	1	10	2.49
1110TR	12 oz, 10 3/8" Diameter x 1 1/4" Height, Soup Plate	Dozen	65.70	1	8	2.41





2109TR



2110TR



2112TR



2113TR



2114TR

Item	Description	U/M	Weight Gross lbs	Inner Pack	Master Pack	Cu. Ft.
2109TR	7 oz, 9" x 6 <sup>3</sup> / <sub>4</sub> " x 1 <sup>1</sup> / <sub>8</sub> ", Deep Platter	Dozen	53.79	1	10	1.81
2110TR	9 oz, 10" x 7 <sup>1</sup> / <sub>2</sub> " x 1 <sup>1</sup> / <sub>8</sub> ", Deep Platter	Dozen	51.15	1	8	1.76
2112TR	16 oz, 12" x 9" x 1 <sup>5</sup> / <sub>8</sub> ", Deep Platter	Dozen	58.30	1	6	2.49
2113TR	24 oz, 13" x 9 <sup>3</sup> / <sub>4</sub> " x 1 <sup>5</sup> / <sub>8</sub> ", Deep Platter	Dozen	49.60	1	4	1.97
2114TR	28 oz, 14 <sup>1</sup> / <sub>8</sub> " x 10 <sup>5</sup> / <sub>8</sub> " x 1 <sup>3</sup> / <sub>4</sub> ", Deep Platter	Dozen	53.57	1	4	2.37



2008TR



2009TR



21010TR



2012TR



2014TR



2016TR

Item	Description	U/M	Weight Gross lbs	Inner Pack	Master Pack	Cu. Ft.
2008TR	8" x 6" x 5/8", Platter	Dozen	54.01	1	16	2.65
2009TR	9" x 6 <sup>5</sup> / <sub>8</sub> " x 3/4", Platter	Dozen	41.23	1	10	1.84
21010TR	9 <sup>7</sup> / <sub>8</sub> " x 7 <sup>1</sup> / <sub>4</sub> " x 3/4", Platter	Dozen	50.86	1	8	1.90
2012TR	12" x 8 <sup>5</sup> / <sub>8</sub> " x 7/8", Platter	Dozen	48.50	1	6	2.06
2014TR	14" x 10" x 1 <sup>1</sup> / <sub>8</sub> ", Platter	Dozen	34.94	0.50	3	2.18
2016TR	16" x 11 <sup>5</sup> / <sub>8</sub> " x 1 <sup>1</sup> / <sub>4</sub> ", Platter	Dozen	51.81	0.50	3	2.13

# Longevity

MELAMINE



5060TR



5065TR



5070TR



5075TR



5085TR



5095TR

Item	Description	U/M	Weight Gross lbs	Inner Pack	Master Pack	Cu. Ft.
5060TR	22 oz, 6 $\frac{7}{8}$ " Diameter x 2 $\frac{1}{4}$ " Height, Rimless Bowl	Dozen	37.92	1	8	2.07
5065TR	32 oz, 7 $\frac{1}{2}$ " Diameter x 2 $\frac{1}{2}$ " Height, Rimless Bowl	Dozen	43.98	1	8	2.59
5070TR	36 oz, 8" Diameter x 2 $\frac{5}{8}$ " Height, Rimless Bowl	Dozen	41.45	1	6	2.10
5075TR	52 oz, 8 $\frac{3}{4}$ " Diameter x 2 $\frac{7}{8}$ " Height, Rimless Bowl	Dozen	47.18	1	6	2.43
5085TR	70 oz, 9 $\frac{3}{4}$ " Diameter x 3 $\frac{1}{4}$ " Height, Rimless Bowl	Dozen	48.06	0.50	4	3.24
5095TR	96 oz, 11" Diameter x 3 $\frac{3}{4}$ " Height, Rimless Bowl	Dozen	51.15	0.50	3	3.66



5206TR



5207TR



5208TR



5265TR



5275TR



5285TR

Item	Description	U/M	Weight Gross lbs	Inner Pack	Master Pack	Cu. Ft.
5206TR	25 oz, 5 $\frac{7}{8}$ " Diameter x 2 $\frac{7}{8}$ " Height, Rice Bowl	Dozen	26.46	1	6	1.35
5207TR	39 oz, 7" Diameter x 3 $\frac{1}{4}$ " Height, Rice Bowl	Dozen	37.15	1	6	2.11
5208TR	56 oz, 8" Diameter x 3 $\frac{1}{2}$ " Height, Rice Bowl	Dozen	41.29	1	6	2.50
5265TR	25 oz, 6 $\frac{1}{4}$ " Diameter x 2 $\frac{3}{4}$ " Height, Scalloped Bowl	Dozen	39.68	1	8	1.92
5275TR	34 oz, 7 $\frac{1}{4}$ " Diameter x 3" Height, Scalloped Bowl	Dozen	40.79	1	6	1.82
5285TR	53 oz, 8 $\frac{1}{4}$ " Diameter x 3 $\frac{1}{2}$ " Height, Scalloped Bowl	Dozen	60.63	0.50	6	3.60





5106TR



5107TR



5108TR



5306TR



5307TR



5308TR



5309TR

Item	Description	U/M	Weight Gross lbs	Inner Pack	Master Pack	Cu. Ft.
5106TR	15 oz, 6" Diameter x 2" Height, Deep Bowl	Dozen	39.24	1	12	1.76
5107TR	24 oz, 7" Diameter x 2¼" Height, Deep Bowl	Dozen	39.68	1	8	1.46
5108TR	34 oz, 8" Diameter x 2½" Height, Deep Bowl	Dozen	50.71	1	8	2.47
5306TR	21 oz, 6" Diameter x 2½" Height, Swirl Bowl	Dozen	29.10	1	6	1.29
5307TR	32 oz, 6¾" Diameter x 2¾" Height, Swirl Bowl	Dozen	37.48	1	6	1.58
5308TR	48 oz, 8" Diameter x 3⅛" Height, Swirl Bowl	Dozen	51.15	0.50	6	2.94
5309TR	72 oz, 9" Diameter x 3½" Height, Swirl Bowl	Dozen	37.92	0.50	3	2.16



8010TR



8011TR



3201TR (Bowl)  
(Lid & Bowl are sold separately)



3201CTR (Lid)

Item	Description	U/M	Weight Gross lbs	Inner Pack	Master Pack	Cu. Ft.
8010TR	75 oz, 10" Diameter x 3⅞" Height, Serving Bowl with Lid	Each	23.15	1	12	3.15
8011TR	80 oz, 11" Diameter x 3¼" Height, Serving Bowl with Lid	Each	29.76	1	12	3.60
3201TR	20 oz, 5¾" Diameter x 3" Height, Noodle Bowl (Lid Sold Separately)	Dozen	29.76	1	6	1.19
3201CTR	5¼" Diameter, Lid only for 3201TR	Dozen	14.33	1	6	0.97

# Longevity



**9156TR • Cup**  
Enlarged to show detail



Item	Description	U/M	Weight Gross lbs	Inner Pack	Master Pack	Cu. Ft.
3004TR	12 oz, 4 $\frac{3}{8}$ " Diameter x 2 $\frac{3}{8}$ " Height, Rice Bowl	Dozen	54.54	1	18	2.63
3006TR	9 oz, 4 $\frac{3}{8}$ " Diameter x 2 $\frac{1}{8}$ " Height, Rice Bowl	Dozen	52.36	1	24	2.60
3008TR	6 oz, 3 $\frac{3}{4}$ " Diameter x 2" Height, Rice Bowl	Dozen	42.99	2	24	1.79
5008TR	35 oz, 8" Diameter x 2 $\frac{5}{8}$ " Height, Special Deep Bowl	Dozen	41.89	1	6	2.27
9152TR	5 oz, 3 $\frac{3}{8}$ " Diameter x 2 $\frac{1}{8}$ " Height, Tea Cup	Dozen	54.67	1	30	2.94
9156TR	1 $\frac{1}{2}$ oz, 2" Diameter x 2 $\frac{1}{4}$ " Height, Cup	Dozen	49.60	5	120	2.84



**7005R • Rice Ladle**  
Enlarged to show detail



Item	Description	U/M	Weight Gross lbs	Inner Pack	Master Pack	Cu. Ft.
7002TR	$\frac{1}{2}$ oz, 4 $\frac{7}{8}$ " x 1 $\frac{5}{8}$ ", Soup Spoon	Dozen	60.63	5	100	1.99
7003R	$\frac{3}{4}$ oz, 5 $\frac{3}{4}$ " x 1 $\frac{3}{4}$ ", Won Ton Soup Spoon	Dozen	52.58	5	100	2.26
7004TR	$\frac{3}{4}$ oz, 5 $\frac{1}{4}$ " x 1 $\frac{3}{4}$ ", Spoon	Dozen	52.66	5	100	2.26
7005R	1 $\frac{1}{2}$ oz, 8 $\frac{1}{4}$ " x 2 $\frac{3}{4}$ ", Rice Ladle	Dozen	48.50	2	30	2.38
7100TR	1 oz, 6 $\frac{1}{4}$ " x 1 $\frac{3}{4}$ " x 2", Soup Spoon	Dozen	45.48	5	60	2.21



**1004TR • Round Plate**  
Enlarged to show detail



Item	Description	U/M	Weight Gross lbs	Inner Pack	Master Pack	Cu. Ft.
1003TR	3 oz, 3 $\frac{7}{8}$ " Diameter x $\frac{3}{4}$ " Height, Sauce Dish	Dozen	54.01	5	50	2.04
102.8TR	2 oz, 3 $\frac{1}{2}$ " Diameter x $\frac{3}{8}$ " Height, Sauce Dish	Dozen	64.77	5	80	1.89
1101TR	1 oz, 2 $\frac{3}{4}$ " Diameter x $\frac{5}{8}$ " Height, Sauce Dish	Dozen	42.97	5	80	1.22
1004TR	4 oz, 4 $\frac{1}{2}$ " Diameter x $\frac{3}{4}$ " Height, Round Plate	Dozen	26.01	1	12	0.90
1102TR	2 oz, 3 $\frac{3}{8}$ " x 2 $\frac{3}{4}$ " x $\frac{1}{2}$ ", Twin Sauce Dish	Dozen	41.89	2	40	1.65

**\*\*Rice Ladle and Soup Spoon are not NSF Certified.\*\***



# Lotus



Platter • Soup Plate • Spoon •  
Rice Bowl • Twin Sauce Dish



# Lotus

MELAMINE



Item	Description	U/M	Weight Gross lbs	Inner Pack	Master Pack	Cu. Ft.
1006TB	6" Diameter x 1/2" Height, Round Plate	Dozen	60.63	1	24	1.96
1007TB	6 7/8" Diameter x 3/4" Height, Round Plate	Dozen	46.03	1	16	1.69
1008TB	7 7/8" Diameter x 5/8" Height, Round Plate	Dozen	55.12	1	12	1.86
1009TB	9 1/8" Diameter x 3/4" Height, Round Plate	Dozen	49.71	1	8	1.66
1010TB	10 3/8" Diameter x 7/8" Height, Round Plate	Dozen	39.48	1	6	1.69
1012TB	11 3/4" Diameter x 7/8" Height, Round Plate	Dozen	44.25	1	4	1.62
1013TB	12 5/8" Diameter x 1" Height, Round Plate	Dozen	43.21	0.50	3	1.77
1014TB	14 1/8" Diameter x 1 1/8" Height, Round Plate	Dozen	51.81	0.50	3	2.22
1016TB	15 1/2" Diameter x 1 1/4" Height, Round Plate	Dozen	48.50	0.50	2	2.62
1015TB	14 3/8" Diameter x 1 3/4" Height, Narrow Rim Round Plate	Dozen	48.50	0.50	2	3.21



Item	Description	U/M	Weight Gross lbs	Inner Pack	Master Pack	Cu. Ft.
1106TB	3 oz, 6" Diameter x 1" Height, Soup Plate	Dozen	48.50	1	18	1.52
1107TB	5 oz, 7" Diameter x 1" Height, Soup Plate	Dozen	52.91	1	16	1.89
1108TB	7 oz, 7 7/8" Diameter x 1" Height, Soup Plate	Dozen	50.04	1	12	1.92
1109TB	10 oz, 9 1/4" Diameter x 1 1/4" Height, Soup Plate	Dozen	68.12	1	10	2.49
1110TB	12 oz, 10 3/8" Diameter x 1 1/4" Height, Soup Plate	Dozen	65.70	1	8	2.41





2109TB



2110TB



2112TB



2113TB



2114TB

Item	Description	U/M	Weight Gross lbs	Inner Pack	Master Pack	Cu. Ft.
2109TB	7 oz, 9" x 6 <sup>3</sup> / <sub>4</sub> " x 1 <sup>1</sup> / <sub>8</sub> ", Deep Platter	Dozen	53.79	1	10	1.81
2110TB	9 oz, 10" x 7 <sup>1</sup> / <sub>2</sub> " x 1 <sup>1</sup> / <sub>8</sub> ", Deep Platter	Dozen	51.15	1	8	1.76
2112TB	16 oz, 12" x 9" x 1 <sup>5</sup> / <sub>8</sub> ", Deep Platter	Dozen	58.30	1	6	2.49
2113TB	24 oz, 13" x 9 <sup>3</sup> / <sub>4</sub> " x 1 <sup>5</sup> / <sub>8</sub> ", Deep Platter	Dozen	49.60	1	4	1.97
2114TB	28 oz, 14 <sup>1</sup> / <sub>8</sub> " x 10 <sup>5</sup> / <sub>8</sub> " x 1 <sup>3</sup> / <sub>4</sub> ", Deep Platter	Dozen	53.57	1	4	2.37



2008TB



2009TB



2010TB



2012TB



2014TB



2016TB

Item	Description	U/M	Weight Gross lbs	Inner Pack	Master Pack	Cu. Ft.
2008TB	8" x 6" x 5 <sup>8</sup> / <sub>8</sub> ", Platter	Dozen	54.01	1	16	2.65
2009TB	9" x 6 <sup>5</sup> / <sub>8</sub> " x 3 <sup>4</sup> / <sub>4</sub> ", Platter	Dozen	41.23	1	10	1.84
2010TB	9 <sup>7</sup> / <sub>8</sub> " x 7 <sup>1</sup> / <sub>4</sub> " x 3 <sup>4</sup> / <sub>4</sub> ", Platter	Dozen	50.86	1	8	1.90
2012TB	12" x 8 <sup>5</sup> / <sub>8</sub> " x 7 <sup>8</sup> / <sub>8</sub> ", Platter	Dozen	48.50	1	6	2.06
2014TB	14" x 10" x 1 <sup>1</sup> / <sub>8</sub> ", Platter	Dozen	34.94	0.50	3	2.18
2016TB	16" x 11 <sup>5</sup> / <sub>8</sub> " x 1 <sup>1</sup> / <sub>4</sub> ", Platter	Dozen	51.81	0.50	3	2.13

# Lotus



5060TB



5065TB



5070TB



5075TB



5085TB



5095TB

Item	Description	U/M	Weight Gross lbs	Inner Pack	Master Pack	Cu. Ft.
5060TB	22 oz, 6 $\frac{1}{8}$ " Diameter x 2 $\frac{1}{4}$ " Height, Rimless Bowl	Dozen	37.92	1	8	2.07
5065TB	32 oz, 7 $\frac{1}{2}$ " Diameter x 2 $\frac{1}{2}$ " Height, Rimless Bowl	Dozen	43.98	1	8	2.59
5070TB	36 oz, 8" Diameter x 2 $\frac{5}{8}$ " Height, Rimless Bowl	Dozen	41.45	1	6	2.10
5075TB	52 oz, 8 $\frac{3}{4}$ " Diameter x 2 $\frac{7}{8}$ " Height, Rimless Bowl	Dozen	47.18	1	6	2.43
5085TB	70 oz, 9 $\frac{3}{4}$ " Diameter x 3 $\frac{1}{4}$ " Height, Rimless Bowl	Dozen	48.06	0.50	4	3.24
5095TB	96 oz, 11" Diameter x 3 $\frac{3}{4}$ " Height, Rimless Bowl	Dozen	51.15	0.50	3	3.66



5206TB



5207TB



5208TB



5265TB



5275TB



5285TB

Item	Description	U/M	Weight Gross lbs	Inner Pack	Master Pack	Cu. Ft.
5206TB	25 oz, 5 $\frac{7}{8}$ " Diameter x 2 $\frac{5}{8}$ " Height, Rice Bowl	Dozen	26.46	1	6	1.35
5207TB	39 oz, 7 $\frac{1}{2}$ " Diameter x 3 $\frac{1}{4}$ " Height, Rice Bowl	Dozen	37.15	1	6	2.11
5208TB	56 oz, 8" Diameter x 3 $\frac{1}{2}$ " Height, Rice Bowl	Dozen	41.29	1	6	2.50
5265TB	25 oz, 6 $\frac{1}{4}$ " Diameter x 2 $\frac{3}{4}$ " Height, Scalloped Bowl	Dozen	39.68	1	6	1.92
5275TB	34 oz, 7 $\frac{1}{4}$ " Diameter x 3" Height, Scalloped Bowl	Dozen	40.79	1	6	1.82
5285TB	53 oz, 8 $\frac{1}{4}$ " Diameter x 3 $\frac{1}{2}$ " Height, Scalloped Bowl	Dozen	60.63	0.50	6	3.60





5306TB



5307TB



5308TB



5309TB



5008TB



5106TB



5107TB



5108TB

Item	Description	U/M	Weight Gross lbs	Inner Pack	Master Pack	Cu. Ft.
5306TB	21 oz, 6" Diameter x 2½" Height, Swirl Bowl	Dozen	29.10	1	6	1.29
5307TB	32 oz, 6⅞" Diameter x 2¾" Height, Swirl Bowl	Dozen	37.48	1	6	1.58
5308TB	48 oz, 8" Diameter x 3⅛" Height, Swirl Bowl	Dozen	51.15	0.50	6	2.94
5309TB	72 oz, 9" Diameter x 3½" Height, Swirl Bowl	Dozen	37.92	0.50	3	2.16
5008TB	35 oz, 8" Diameter x 2⅝" Height, Special Deep Bowl	Dozen	41.89	1	6	2.27
5106TB	15 oz, 6" Diameter x 2" Height, Deep Bowl	Dozen	39.24	1	12	1.76
5107TB	24 oz, 7" Diameter x 2¼" Height, Deep Bowl	Dozen	39.68	1	8	1.46
5108TB	34 oz, 8" Diameter x 2½" Height, Deep Bowl	Dozen	50.71	1	8	2.47



8010TB



8011TB



3201TB (Bowl)



3201CTB (Lid)

(Lid & Bowl are sold separately)

Item	Description	U/M	Weight Gross lbs	Inner Pack	Master Pack	Cu. Ft.
8010TB	75 oz, 10" Diameter x 3⅝" Height, Serving Bowl with Lid	Each	23.15	1	12	3.15
8011TB	80 oz, 11" Diameter x 3¼" Height, Serving Bowl with Lid	Each	29.76	1	12	3.60
3201TB	20 oz, 5¾" Diameter x 3" Height, Noodle Bowl (Lid Sold Separately)	Dozen	29.76	1	6	1.19
3201CTB	5 ¼" Diameter, Lid Only for 3201TB	Dozen	14.33	1	6	0.97

# Lotus



**9152TB Tea • Cup**  
Enlarged to show detail



3004TB



3006TB



3008TB



9152TB

Item	Description	U/M	Weight Gross lbs	Inner Pack	Master Pack	Cu. Ft.
3004TB	12 oz, 4 $\frac{7}{8}$ " Diameter x 2 $\frac{3}{8}$ " Height, Rice Bowl	Dozen	54.54	1	18	2.63
3006TB	9 oz, 4 $\frac{3}{8}$ " Diameter x 2 $\frac{1}{8}$ " Height, Rice Bowl	Dozen	52.36	1	24	2.60
3008TB	6 oz, 3 $\frac{3}{4}$ " Diameter x 2" Height, Rice Bowl	Dozen	42.99	2	24	1.79
9152TB	5 oz, 3 $\frac{1}{8}$ " Diameter x 2 $\frac{1}{8}$ " Height, Tea Cup	Dozen	54.67	1	30	2.94



**7005B • Rice Ladle**  
Enlarged to show detail



7005B



7007B



7004TB



7003B



7100TB

Item	Description	U/M	Weight Gross lbs	Inner Pack	Master Pack	Cu. Ft.
7005B	1 $\frac{1}{2}$ oz, 8 $\frac{1}{4}$ x 2 $\frac{3}{4}$ ", Rice Ladle	Dozen	48.05	2	30	2.38
7007B	2 $\frac{1}{2}$ oz, 8 $\frac{7}{8}$ " x 2 $\frac{3}{4}$ ", Ladle/Spoon	Dozen	44.78	2	30	2.55
7004TB	$\frac{3}{4}$ oz, 5 $\frac{5}{8}$ " x 1 $\frac{3}{4}$ ", Spoon	Dozen	52.66	5	100	2.26
7003B	$\frac{3}{4}$ oz, 5 $\frac{3}{4}$ " x 1 $\frac{3}{4}$ ", Won Ton Soup Spoon	Dozen	52.58	5	100	2.26
7100TB	1 oz, 6 $\frac{1}{4}$ " x 1 $\frac{3}{4}$ ", Soup Spoon	Dozen	45.48	5	60	2.21



**1004TB • Round Plate**  
Enlarged to show detail



1003TB



102.8TB



1101TB



1004TB



1102TB

Item	Description	U/M	Weight Gross lbs	Inner Pack	Master Pack	Cu. Ft.
1003TB	3 oz, 3 $\frac{7}{8}$ " Diameter x $\frac{3}{4}$ " Height, Sauce Dish	Dozen	54.01	5	50	2.04
102.8TB	2 oz, 3 $\frac{1}{2}$ " Diameter x $\frac{3}{8}$ " Height, Sauce Dish	Dozen	64.77	5	80	1.89
1101TB	1 oz, 2 $\frac{3}{4}$ " Diameter x $\frac{5}{8}$ " Height, Sauce Dish	Dozen	42.97	5	80	1.22
1004TB	4 oz, 4 $\frac{1}{2}$ " Diameter x $\frac{3}{4}$ " Height, Round Plate	Dozen	26.01	1	12	0.90
1102TB	2 oz, 3 $\frac{3}{8}$ " x 2 $\frac{3}{4}$ " x $\frac{1}{2}$ ", Twin Sauce Dish	Dozen	41.89	2	40	1.65

\*\*Rice Ladle and Soup Spoon are not NSF Certified.\*\*

# Peacock

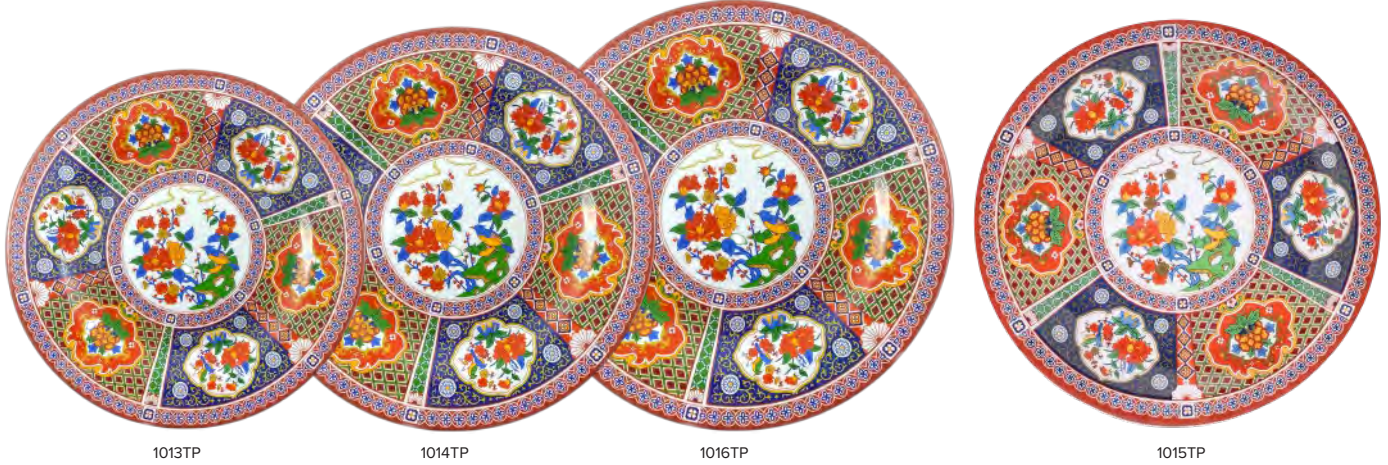
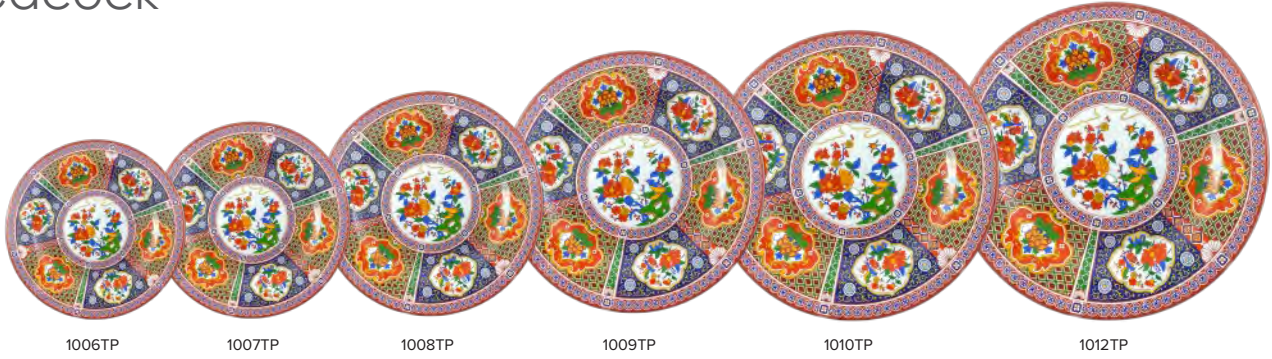

Plate • Soup Plate • Spoon •  
Rice Bowl • Lid • Bowl • Tea Cup



# Peacock

MELAMINE



Item	Description	U/M	Weight Gross lbs	Inner Pack	Master Pack	Cu. Ft.
1006TP	6" Diameter x 1/2" Height, Round Plate	Dozen	60.63	1	24	1.96
1007TP	6 7/8" Diameter x 3/4" Height, Round Plate	Dozen	46.03	1	16	1.69
1008TP	7 1/2" Diameter x 5/8" Height, Round Plate	Dozen	55.12	1	12	1.86
1009TP	9 1/8" Diameter x 3/4" Height, Round Plate	Dozen	49.71	1	8	1.66
1010TP	10 3/8" Diameter x 7/8" Height, Round Plate	Dozen	39.48	1	6	1.69
1012TP	11 3/4" Diameter x 7/8" Height, Round Plate	Dozen	44.25	1	4	1.62
1013TP	12 5/8" Diameter x 1" Height, Round Plate	Dozen	43.21	0.50	3	1.77
1014TP	14 1/8" Diameter x 1 1/8" Height, Round Plate	Dozen	51.81	0.50	3	2.22
1016TP	15 1/2" Diameter x 1 1/4" Height, Round Plate	Dozen	48.50	0.50	2	2.62
1015TP	14 3/8" Diameter x 1 3/4" Height, Narrow Rim Round Plate	Dozen	48.50	0.50	2	3.21



Item	Description	U/M	Weight Gross lbs	Inner Pack	Master Pack	Cu. Ft.
1106TP	3 oz, 6" Diameter x 1" Height, Soup Plate	Dozen	48.50	1	18	1.52
1107TP	5 oz, 7" Diameter x 1" Height, Soup Plate	Dozen	52.91	1	16	1.89
1108TP	7 oz, 7 7/8" Diameter x 1" Height, Soup Plate	Dozen	50.04	1	12	1.92
1109TP	10 oz, 9 1/4" Diameter x 1 1/4" Height, Soup Plate	Dozen	68.12	1	10	2.49
1110TP	12 oz, 10 3/8" Diameter x 1 1/4" Height, Soup Plate	Dozen	65.70	1	8	2.41





2109TP



2110TP



2112TP



2113TP



2114TP

Item	Description	U/M	Weight Gross lbs	Inner Pack	Master Pack	Cu. Ft.
2109TP	7 oz, 9" x 6 <sup>3</sup> / <sub>4</sub> " x 1 <sup>1</sup> / <sub>8</sub> ", Deep Platter	Dozen	53.79	1	10	1.81
2110TP	9 oz, 10" x 7 <sup>1</sup> / <sub>2</sub> " x 1 <sup>1</sup> / <sub>8</sub> ", Deep Platter	Dozen	51.15	1	8	1.76
2112TP	16 oz, 12" x 9" x 1 <sup>5</sup> / <sub>8</sub> ", Deep Platter	Dozen	58.30	1	6	2.49
2113TP	24 oz, 13" x 9 <sup>3</sup> / <sub>4</sub> " x 1 <sup>5</sup> / <sub>8</sub> ", Deep Platter	Dozen	49.60	1	4	1.97
2114TP	28 oz, 14 <sup>1</sup> / <sub>8</sub> " x 10 <sup>5</sup> / <sub>8</sub> " x 1 <sup>3</sup> / <sub>4</sub> ", Deep Platter	Dozen	53.57	1	4	2.37



2008TP



2009TP



2010TP



2012TP



2014TP



2016TP

Item	Description	U/M	Weight Gross lbs	Inner Pack	Master Pack	Cu. Ft.
2008TP	8" x 6" x 5 <sup>5</sup> / <sub>8</sub> ", Platter	Dozen	54.01	1	16	2.65
2009TP	9" x 6 <sup>5</sup> / <sub>8</sub> " x 3 <sup>3</sup> / <sub>4</sub> ", Platter	Dozen	41.23	1	10	1.84
2010TP	9 <sup>7</sup> / <sub>8</sub> " x 7 <sup>1</sup> / <sub>4</sub> " x 3 <sup>3</sup> / <sub>4</sub> ", Platter	Dozen	50.86	1	8	1.90
2012TP	12" x 8 <sup>5</sup> / <sub>8</sub> " x 7 <sup>7</sup> / <sub>8</sub> ", Platter	Dozen	48.50	1	6	2.06
2014TP	14" x 10" x 1 <sup>1</sup> / <sub>8</sub> ", Platter	Dozen	34.94	0.50	3	2.18
2016TP	16" x 11 <sup>5</sup> / <sub>8</sub> " x 1 <sup>1</sup> / <sub>4</sub> ", Platter	Dozen	51.81	0.50	3	2.13

# Peacock

MELAMINE



5060TP



5065TP



5070TP



5075TP



5085TP



5095TP

Item	Description	U/M	Weight Gross lbs	Inner Pack	Master Pack	Cu.Ft
5060TP	22 oz, 6 $\frac{7}{8}$ " Diameter x 2 $\frac{1}{4}$ " Height, Rimless Bowl	Dozen	37.92	1	8	2.07
5065TP	32 oz, 7 $\frac{1}{2}$ " Diameter x 2 $\frac{1}{2}$ " Height, Rimless Bowl	Dozen	43.98	1	8	2.59
5070TP	36 oz, 8" Diameter x 2 $\frac{5}{8}$ " Height, Rimless Bowl	Dozen	41.45	1	6	2.10
5075TP	52 oz, 8 $\frac{3}{4}$ " Diameter x 2 $\frac{7}{8}$ " Height, Rimless Bowl	Dozen	47.18	1	6	2.43
5085TP	70 oz, 9 $\frac{3}{4}$ " Diameter x 3 $\frac{1}{4}$ " Height, Rimless Bowl	Dozen	48.06	0.50	4	3.24
5095TP	96 oz, 11" Diameter x 3 $\frac{3}{4}$ " Height, Rimless Bowl	Dozen	51.15	0.50	3	3.66



5206TP



5207TP



5208TP



5265TP



5275TP



5285TP

Item	Description	U/M	Weight Gross lbs	Inner Pack	Master Pack	Cu.Ft
5206TP	25 oz, 5 $\frac{7}{8}$ " Diameter x 2 $\frac{7}{8}$ " Height, Rice Bowl	Dozen	26.46	1	6	1.35
5207TP	39 oz, 7" Diameter x 3 $\frac{1}{4}$ " Height, Rice Bowl	Dozen	37.15	1	6	2.11
5208TP	56 oz, 8" Diameter x 3 $\frac{1}{2}$ " Height, Rice Bowl	Dozen	41.29	1	6	2.50
5265TP	25 oz, 6 $\frac{1}{4}$ " Diameter x 2 $\frac{3}{4}$ " Height, Scalloped Bowl	Dozen	39.68	1	8	1.92
5275TP	34 oz, 7 $\frac{1}{4}$ " Diameter x 3" Height, Scalloped Bowl	Dozen	40.79	1	6	1.82
5285TP	53 oz, 8 $\frac{1}{4}$ " Diameter x 3 $\frac{1}{2}$ " Height, Scalloped Bowl	Dozen	60.63	0.50	6	3.60



5106TP



5107TP



5108TP



5306TP



5307TP



5308TP



5309TP

Item	Description	U/M	Weight Gross lbs	Inner Pack	Master Pack	Cu. Ft.
5106TP	15 oz, 6" Diameter x 2" Height, Deep Bowl	Dozen	39.24	1	12	1.76
5107TP	24 oz, 7" Diameter x 2¼" Height, Deep Bowl	Dozen	39.68	1	8	1.46
5108TP	34 oz, 8" Diameter x 2½" Height, Deep Bowl	Dozen	50.71	1	8	2.47
5306TP	21 oz, 6" Diameter x 2½" Height, Swirl Bowl	Dozen	29.10	1	6	1.29
5307TP	32 oz, 6¾" Diameter x 2¾" Height, Swirl Bowl	Dozen	37.48	1	6	1.58
5308TP	48 oz, 8" Diameter x 3½" Height, Swirl Bowl	Dozen	51.15	0.50	6	2.94
5309TP	72 oz, 9" Diameter x 3½" Height, Swirl Bowl	Dozen	37.92	0.50	3	2.16



8010TP



8011TP



3201TP (Bowl)  
(Lid & Bowl are sold separately)



3201CTP (Lid)

Item	Description	U/M	Weight Gross lbs	Inner Pack	Master Pack	Cu. Ft.
8010TP	75 oz, 10" Diameter x 3½" Height, Serving Bowl with Lid	Each	23.15	1	12	3.15
8011TP	80 oz, 11" Diameter x 3¼" Height, Serving Bowl with Lid	Each	29.76	1	12	3.60
3201TP	20 oz, 5¾" Diameter x 3" Height, Noodle Bowl (Lid Sold Separately)	Dozen	29.76	1	6	1.19
3201CTP	5¼" Diameter, Lid only for 3201TP	Dozen	14.33	1	6	0.97

# Peacock



**9152TB • Tea Cup**  
Enlarged to show detail



3004TP



3006TP



3008TP



9152TP

Item	Description	U/M	Weight Gross lbs	Inner Pack	Master Pack	Cu. Ft.
3004TP	12 oz, 4 $\frac{7}{8}$ " Diameter x 2 $\frac{3}{8}$ " Height, Rice Bowl	Dozen	54.54	1	18	2.63
3006TP	9 oz, 4 $\frac{3}{8}$ " Diameter x 2 $\frac{1}{8}$ " Height, Rice Bowl	Dozen	52.36	1	24	2.60
3008TP	6 oz, 3 $\frac{3}{4}$ " Diameter x 2" Height, Rice Bowl	Dozen	42.99	2	24	1.79
9152TP	5 oz, 3 $\frac{1}{8}$ " Diameter x 2 $\frac{1}{8}$ " Height, Tea Cup	Dozen	54.67	1	30	2.94

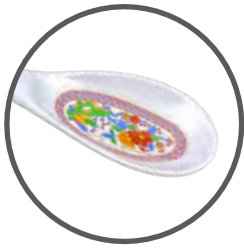

**7005P • Rice Ladle**  
Enlarged to show detail



7002TP



7003P



7004TP



7005P

Item	Description	U/M	Weight Gross lbs	Inner Pack	Master Pack	Cu. Ft.
7002TP	$\frac{1}{2}$ oz, 4 $\frac{7}{8}$ " x 1 $\frac{5}{8}$ ", Spoon	Dozen	60.63	5	100	1.99
7003P	$\frac{3}{4}$ oz, 5 $\frac{3}{4}$ " x 1 $\frac{3}{4}$ ", Won Ton Soup Spoon	Dozen	52.58	5	100	2.26
7004TP	$\frac{3}{4}$ oz, 5 $\frac{5}{8}$ " x 1 $\frac{3}{4}$ ", Spoon	Dozen	52.66	5	100	2.26
7005P	1 $\frac{1}{2}$ oz, 8 $\frac{1}{4}$ " x 2 $\frac{3}{4}$ ", Rice Ladle	Dozen	48.50	2	30	2.38



**1004TB • Round Plate**  
Enlarged to show detail



102.8TP



1101TP



1003TP



1004TP



1102TP

Item	Description	U/M	Weight Gross lbs	Inner Pack	Master Pack	Cu. Ft.
102.8TP	2 oz, 3 $\frac{1}{2}$ " Diameter x $\frac{3}{8}$ " Height, Sauce Dish	Dozen	64.77	5	80	1.89
1101TP	1 oz, 2 $\frac{3}{4}$ " Diameter x $\frac{5}{8}$ " Height, Sauce Dish	Dozen	42.97	5	80	1.22
1003TP	3 oz, 3 $\frac{3}{8}$ " Diameter x $\frac{3}{4}$ " Height, Sauce Dish	Dozen	54.01	5	50	2.04
1004TP	4 oz, 4 $\frac{1}{2}$ " Diameter x $\frac{3}{4}$ " Height, Round Plate	Dozen	26.01	1	12	0.90
1102TP	2 oz, 3 $\frac{3}{8}$ " x 2 $\frac{3}{4}$ " x $\frac{1}{2}$ ", Twin Sauce Dish	Dozen	41.89	2	40	1.65

**\*\*Rice Ladle and Soup Spoon are not NSF Certified.\*\***





# Rose



Soup Plates • Platter • Rice  
Bowl • Rimless Bowl • Tea Cup •  
Sauce Dish



# Rose



Item	Description	U/M	Weight Gross lbs	Inner Pack	Master Pack	Cu. Ft.
1006AR	6" Diameter x 1/2" Height, Round Plate	Dozen	60.63	1	24	1.96
1007AR	6 7/8" Diameter x 3/4" Height, Round Plate	Dozen	46.03	1	16	1.69
1008AR	7 7/8" Diameter x 5/8" Height, Round Plate	Dozen	55.12	1	12	1.86
1009AR	9 1/8" Diameter x 3/4" Height, Round Plate	Dozen	49.71	1	8	1.66
1010AR	10 3/8" Diameter x 7/8" Height, Round Plate	Dozen	39.48	1	6	1.69
1012AR	11 3/4" Diameter x 7/8" Height, Round Plate	Dozen	44.25	1	4	1.62
1013AR	12 5/8" Diameter x 1" Height, Round Plate	Dozen	43.21	0.50	3	1.77
1014AR	14 1/8" Diameter x 1 1/8" Height, Round Plate	Dozen	51.81	0.50	3	2.22
1016AR	15 1/2" Diameter x 1 1/4" Height, Round Plate	Dozen	48.50	0.50	2	2.62
1015AR	14 3/8" Diameter x 1 3/4" Height, Narrow Round Plate	Dozen	48.50	0.50	2	3.21



Item	Description	U/M	Weight Gross lbs	Inner Pack	Master Pack	Cu. Ft.
1106AR	3 oz, 6" Diameter x 1" Height, Soup Plate	Dozen	48.50	1	18	1.52
1107AR	5 oz, 7" Diameter x 1" Height, Soup Plate	Dozen	52.91	1	16	1.89
1108AR	7 oz, 7 7/8" Diameter x 1" Height, Soup Plate	Dozen	50.04	1	12	1.92
1109AR	10 oz, 9 1/4" Diameter x 1 1/4" Height, Soup Plate	Dozen	68.12	1	10	2.49
1110AR	12 oz, 10 3/8" Diameter x 1 1/4" Height, Soup Plate	Dozen	65.70	1	8	2.41





2109AR



2110AR



2112AR



2113AR



2114AR

Item	Description	U/M	Weight Gross lbs	Inner Pack	Master Pack	Cu. Ft.
2109AR	7 oz, 9" x 6 <sup>3</sup> / <sub>4</sub> " x 1 <sup>1</sup> / <sub>8</sub> ", Deep Platter	Dozen	53.79	1	10	1.81
2110AR	9 oz, 10" x 7 <sup>1</sup> / <sub>2</sub> " x 1 <sup>1</sup> / <sub>8</sub> ", Deep Platter	Dozen	51.15	1	8	1.76
2112AR	16 oz, 12" x 9" x 1 <sup>5</sup> / <sub>8</sub> ", Deep Platter	Dozen	58.30	1	6	2.49
2113AR	24 oz, 13" x 9 <sup>3</sup> / <sub>4</sub> " x 1 <sup>5</sup> / <sub>8</sub> ", Deep Platter	Dozen	49.60	1	4	1.97
2114AR	28 oz, 14 <sup>1</sup> / <sub>8</sub> " x 10 <sup>5</sup> / <sub>8</sub> " x 1 <sup>3</sup> / <sub>4</sub> ", Deep Platter	Dozen	53.57	1	4	2.37



2008AR



2009AR



2010AR



2012AR



2014AR



2016AR

Item	Description	U/M	Weight Gross lbs	Inner Pack	Master Pack	Cu. Ft.
2008AR	8" x 6" x 5 <sup>8</sup> / <sub>8</sub> ", Platter	Dozen	54.01	1	16	2.65
2009AR	9" x 6 <sup>5</sup> / <sub>8</sub> " x 3 <sup>4</sup> / <sub>4</sub> ", Platter	Dozen	41.23	1	10	1.84
2010AR	9 <sup>7</sup> / <sub>8</sub> " x 7 1 <sup>4</sup> / <sub>4</sub> " x 3 <sup>4</sup> / <sub>4</sub> ", Platter	Dozen	50.86	1	8	1.90
2012AR	12" x 8 <sup>5</sup> / <sub>8</sub> " x 7 <sup>8</sup> / <sub>8</sub> ", Platter	Dozen	48.50	1	6	2.06
2014AR	14" x 10" x 1 <sup>1</sup> / <sub>8</sub> ", Platter	Dozen	34.94	0.50	3	2.18
2016AR	16" x 11 <sup>5</sup> / <sub>8</sub> " x 1 <sup>1</sup> / <sub>4</sub> ", Platter	Dozen	51.81	0.50	3	2.13

# Rose



5060AR



5065AR



5070AR



5075AR



5085AR



5095AR

Item	Description	U/M	Weight Gross lbs	Inner Pack	Master Pack	Cu. Ft.
5060AR	22 oz, 6 $\frac{7}{8}$ " Diameter x 2 $\frac{1}{4}$ " Height, Rimless Bowl	Dozen	37.92	1	8	2.07
5065AR	32 oz, 7 $\frac{1}{2}$ " Diameter x 2 $\frac{1}{2}$ " Height, Rimless Bowl	Dozen	43.98	1	8	2.59
5070AR	36 oz, 8" Diameter x 2 $\frac{5}{8}$ " Height, Rimless Bowl	Dozen	41.45	1	6	2.10
5075AR	52 oz, 8 $\frac{3}{4}$ " Diameter x 2 $\frac{7}{8}$ " Height, Rimless Bowl	Dozen	47.18	1	6	2.43
5085AR	70 oz, 9 $\frac{3}{4}$ " Diameter x 3 $\frac{1}{4}$ " Height, Rimless Bowl	Dozen	48.06	0.5	4	3.24
5095AR	96 oz, 11" Diameter x 3 $\frac{3}{4}$ " Height, Rimless Bowl	Dozen	51.15	0.5	3	3.66



5206AR



5207AR



5208AR



5306AR



5307AR



5308AR



5309AR

Item	Description	U/M	Weight Gross lbs	Inner Pack	Master Pack	Cu. Ft.
5206AR	25 oz, 5 $\frac{7}{8}$ " Diameter x 2 $\frac{7}{8}$ " Height, Rice Bowl	Dozen	26.46	1	6	1.35
5207AR	39 oz, 7" Diameter x 3 $\frac{1}{4}$ " Height, Rice Bowl	Dozen	37.15	1	6	2.11
5208AR	56 oz, 8" Diameter x 3 $\frac{1}{2}$ " Height, Rice Bowl	Dozen	41.29	1	6	2.50
5306AR	21 oz, 6" Diameter x 2 $\frac{1}{2}$ " Height, Swirl Bowl	Dozen	29.10	1	6	1.29
5307AR	32 oz, 6 $\frac{7}{8}$ " Diameter x 2 $\frac{3}{4}$ " Height, Swirl Bowl	Dozen	37.48	1	6	1.58
5308AR	48 oz, 8" Diameter x 3 $\frac{1}{8}$ " Height, Swirl Bowl	Dozen	51.15	0.50	6	2.94
5309AR	72 oz, 9" Diameter x 3 $\frac{1}{2}$ " Height, Swirl Bowl	Dozen	37.92	0.50	3	2.16





5106AR



5107AR



5108AR



5265AR



5275AR



5285AR

Item	Description	U/M	Weight Gross lbs	Inner Pack	Master Pack	Cu. Ft.
5106AR	15 oz, 6" Diameter x 2" Height, Deep Bowl	Dozen	39.24	1	12	1.76
5107AR	24 oz, 7" Diameter x 2¼" Height, Deep Bowl	Dozen	39.68	1	8	1.46
5108AR	34 oz, 8" Diameter x 2½" Height, Deep Bowl	Dozen	50.71	1	8	2.47
5265AR	25 oz, 6¼" Diameter x 2¾" Height, Scalloped Bowl	Dozen	39.68	1	8	1.92
5275AR	34 oz, 7¼" Diameter x 3" Height, Scalloped Bowl	Dozen	40.79	1	6	1.82
5285AR	53 oz, 8¼" Diameter x 3½" Height, Scalloped Bowl	Dozen	60.63	0.50	6	3.60



8010AR



8011AR



3201AR (Bowl)  
(Lid & Bowl are sold separately)



3201CAR (Lid)

Item	Description	U/M	Weight Gross lbs	Inner Pack	Master Pack	Cu. Ft.
8010AR	75 oz, 10" Diameter x 3⅛" Height, Serving Bowl with Lid	Each	23.15	1	12	3.15
8011AR	80 oz, 11" Diameter x 3¼" Height, Serving Bowl with Lid	Each	29.76	1	12	3.60
3201AR	20 oz, 5¾" Diameter x 3" Height, Noodle Bowl (Lid Sold Separately)	Dozen	29.76	1	6	1.19
3201CAR	5¼" Diameter, Lid only for 3201AR	Dozen	14.33	1	6	0.97

# Rose



**9152TB • Tea Cup**  
Enlarged to show detail



3004AR



3006AR



3008AR



9152AR

Item	Description	U/M	Weight Gross lbs	Inner Pack	Master Pack	Cu. Ft.
3004AR	12 oz, 4 <sup>7</sup> / <sub>8</sub> " Diameter x 2 <sup>3</sup> / <sub>8</sub> " Height, Rice Bowl	Dozen	54.54	1	18	2.63
3006AR	9 oz, 4 <sup>3</sup> / <sub>8</sub> " Diameter x 2 <sup>1</sup> / <sub>8</sub> " Height, Rice Bowl	Dozen	52.36	1	24	2.60
3008AR	6 oz, 3 <sup>3</sup> / <sub>4</sub> " Diameter x 2" Height, Rice Bowl	Dozen	42.99	2	24	1.79
9152AR	5 oz, 3 <sup>1</sup> / <sub>8</sub> " Diameter x 2 <sup>1</sup> / <sub>8</sub> " Height, Tea Cup	Dozen	54.67	1	30	2.94



**7005AR • Rice Ladle**  
Enlarged to show detail



7003AR



7004AR



7005AR

Item	Description	U/M	Weight Gross lbs	Inner Pack	Master Pack	Cu. Ft.
7003AR	¾ oz, 5 <sup>3</sup> / <sub>4</sub> " x 1 <sup>3</sup> / <sub>4</sub> ", Won Ton Soup Spoon	Dozen	52.58	5	100	2.26
7004AR	¾ oz, 5 <sup>5</sup> / <sub>8</sub> " x 1 <sup>3</sup> / <sub>4</sub> ", Spoon	Dozen	52.66	5	100	2.26
7005AR	1 ½ oz, 8 <sup>1</sup> / <sub>4</sub> " x 2 <sup>3</sup> / <sub>4</sub> ", Rice Ladle	Dozen	48.50	2	30	2.38

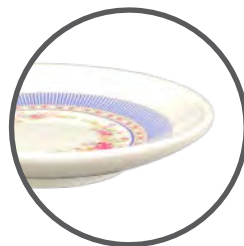

**1004AR • Round Plate**  
Enlarged to show detail



1003AR



102.8AR



1101AR



1004AR



1102AR

Item	Description	U/M	Weight Gross lbs	Inner Pack	Master Pack	Cu. Ft.
1003AR	3 oz, 3 <sup>5</sup> / <sub>8</sub> " Diameter x ¾" Height, Sauce Dish	Dozen	54.01	5	50	2.04
102.8AR	2 oz, 3 <sup>1</sup> / <sub>2</sub> " Diameter x ¾" Height, Sauce Dish	Dozen	64.77	5	80	1.89
1101AR	1 oz, 2 <sup>3</sup> / <sub>4</sub> " Diameter x 5 <sup>5</sup> / <sub>8</sub> " Height, Sauce Dish	Dozen	42.97	5	80	1.22
1004AR	4 oz, 4 <sup>1</sup> / <sub>2</sub> " Diameter x ¾" Height, Round Plate	Dozen	26.01	1	12	0.90
1102AR	2 oz, 3 <sup>3</sup> / <sub>8</sub> " x 2 <sup>3</sup> / <sub>4</sub> " x ½", Twin Sauce Dish	Dozen	41.89	2	40	1.65

**\*\*Rice Ladle and Soup Spoon are not NSF Certified.\*\***



# Blue Bamboo



Platter • Plates • Deep Bowl •  
Sauce Bowl • Soup Ladle



# Blue Bamboo



Item	Description	U/M	Weight Gross lbs	Inner Pack	Master Pack	Cu. Ft.
1006BB	6" Diameter x ½" Height, Round Plate	Dozen	60.63	1	24	1.96
1007BB	6⅞" Diameter x ¾" Height, Round Plate	Dozen	46.03	1	16	1.69
1008BB	7⅞" Diameter x ⅝" Height, Round Plate	Dozen	55.12	1	12	1.86
1009BB	9⅞" Diameter x ¾" Height, Round Plate	Dozen	49.71	1	8	1.66
1010BB	10⅜" Diameter x ⅞" Height, Round Plate	Dozen	39.48	1	6	1.69
1012BB	11¾" Diameter x ⅞" Height, Round Plate	Dozen	44.25	1	4	1.62
1014BB	14⅞" Diameter x 1" Height, Round Plate	Dozen	51.81	0.50	3	2.22

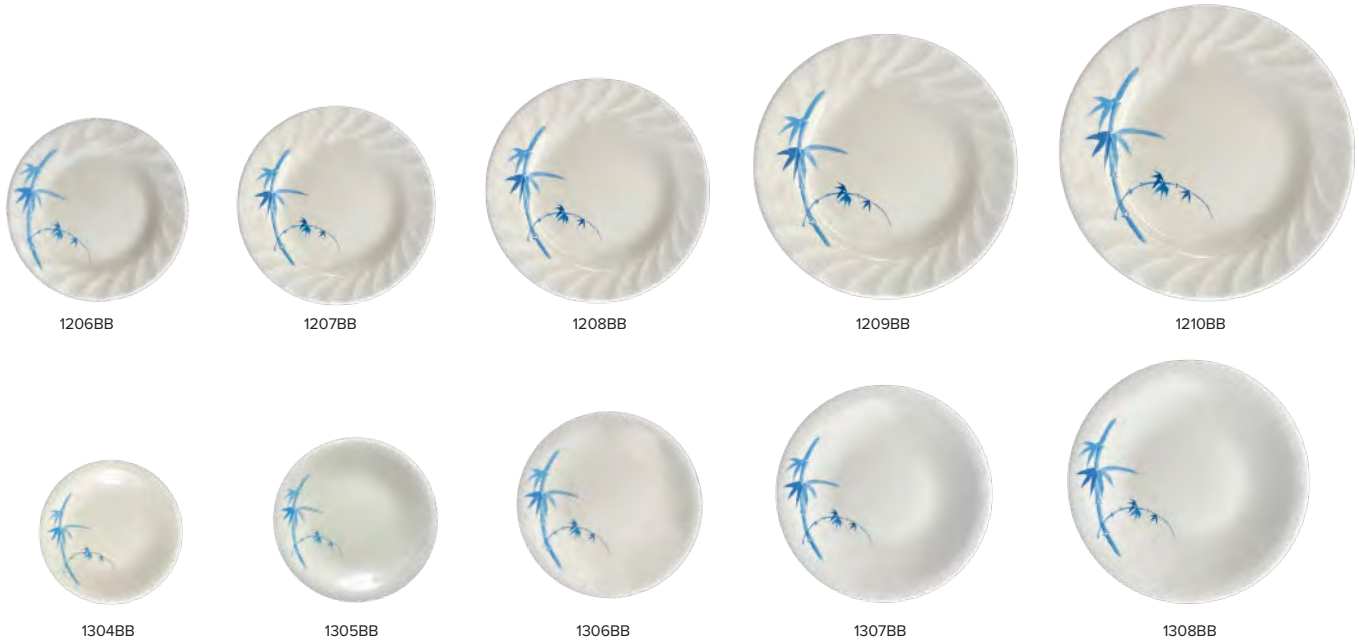

Item	Description	U/M	Weight Gross lbs	Inner Pack	Master Pack	Cu. Ft.
1206BB	6" Diameter x ¾" Height, Curved Rim Plate	Dozen	47.40	1	18	1.63
1207BB	7" Diameter x 1" Height, Curved Rim Plate	Dozen	60.19	1	16	2.20
1208BB	8" Diameter x 1⅞" Height, Curved Rim Plate	Dozen	55.56	1	12	2.19
1209BB	9¼" Diameter x 1⅞" Height, Curved Rim Plate	Dozen	52.47	1	8	2.17
1210BB	10½" Diameter x 1⅞" Height, Curved Rim Plate	Dozen	50.71	1	6	2.33
1304BB	4¾" Diameter x ⅝" Height, Dinner Plate	Dozen	36.16	1	24	1.42
1305BB	5¼" Diameter x ¾" Height, Dinner Plate	Dozen	44.09	1	24	2.00
1306BB	6⅞" Diameter x ¾" Height, Dinner Plate	Dozen	34.17	1	12	1.57
1307BB	7⅞" Diameter x 1" Height, Dinner Plate	Dozen	31.53	1	8	1.47
1308BB	8⅞" Diameter x 1⅞" Height, Dinner Plate	Dozen	24.25	1	4	1.13



# Blue Bamboo

2023



1350BB



1360BB



1365BB



1203BB



2008BB



2009BB



2010BB



2012BB

Item	Description	U/M	Weight Gross lbs	Inner Pack	Master Pack	Cu. Ft.
1350BB	5½" Diameter x 1½" Height, Soup Plate	Dozen	27.56	1	12	1.41
1360BB	5¾" Diameter x ¾" Height, Plate	Dozen	38.80	1	12	2.53
1365BB	6½" Diameter x 1½" Height, Soup Plate	Dozen	40.12	1	12	2.15
1203BB	6" x 5½" x ¾", Oblong Platter	Dozen	36.38	1	12	1.26
2008BB	8" x 6" x 5⁄8", Platter	Dozen	54.01	1	16	2.65
2009BB	9" x 6½" x ¾", Platter	Dozen	41.23	1	10	1.84
2010BB	9¾" x 7¼" x ¾" Platter	Dozen	50.86	1	8	1.90
2012BB	12" x 8½" x 7⁄8", Platter	Dozen	48.50	1	6	2.06



0900BB



1501BB



1505BB



1535BB



1503BB



1504BB



1502BB



0011BB

Item	Description	U/M	Weight Gross lbs	Inner Pack	Master Pack	Cu. Ft.
0900BB	13½" x 4½" x 5⁄8", Sandwich Tray	Dozen	53.57	1	8	2.24
1501BB	8½" x 3¾" x 1", Vegetable Serving Plate	Dozen	28.66	1	6	1.06
1503BB	6¾" x 4½" x 1", Bamboo Plate	Dozen	44.09	1	12	1.87
1504BB	6¾" x 4½" x 1½", Barbecue Plate	Dozen	39.68	1	12	1.86
1505BB	8¼" x 5½" x 1", Barbecue Plate	Dozen	48.50	1	8	2.09
1535BB	5¼" x 3¼" x ¾", Plate	Dozen	31.53	1	12	1.24
1502BB	9 ⅜" x 4¼" x 1", Rectangular Barbecue Plate	Dozen	68.56	1	12	3.01
0011BB	8 ½" x 4 ¾" x 1 ½", Bamboo Sashimi Platter	Dozen	37.63	1	6	1.88

MELAMINE

# Blue Bamboo

MELAMINE



1607BB



1608BB



1609BB



0010BB



1201BB



1202BB

Item	Description	U/M	Weight Gross lbs	Inner Pack	Master Pack	Cu. Ft.
1607BB	2 oz, 4" x 2 $\frac{3}{4}$ " x $\frac{7}{8}$ ", Wavy Shape Sauce Dish	Dozen	33.29	1	24	1.35
1608BB	5 $\frac{3}{4}$ " x 4" x $\frac{3}{4}$ ", Wavy Shape Barbecue Plate	Dozen	31.08	1	12	1.18
1609BB	8 $\frac{1}{2}$ " x 5 $\frac{1}{2}$ " x $\frac{7}{8}$ ", Wavy Shape Barbecue Plate	Dozen	28.66	1	6	1.15
0010BB	6 $\frac{1}{2}$ " x 5 $\frac{1}{2}$ " x 1 $\frac{1}{8}$ ", Plate	Dozen	35.71	1	6	1.19
1201BB	4 $\frac{3}{4}$ " x 4 $\frac{1}{4}$ " x $\frac{5}{8}$ ", Plate	Dozen	29.83	1	12	0.89
1202BB	5 $\frac{1}{2}$ " x 4 $\frac{3}{4}$ " x $\frac{3}{4}$ ", Plate	Dozen	37.43	1	12	1.30



0901BB



0902BB



0903BB



2308BB



2309BB



2311BB

Item	Description	U/M	Weight Gross lbs	Inner Pack	Master Pack	Cu. Ft.
0901BB	13 $\frac{1}{8}$ " x 10 $\frac{1}{4}$ " x $\frac{3}{4}$ ", Tray	Dozen	19.00	0.50	2	0.96
0902BB	15 $\frac{1}{4}$ " x 11 $\frac{1}{2}$ " x $\frac{7}{8}$ ", Tray	Dozen	24.54	0.50	2	1.34
0903BB	17" x 12 $\frac{5}{8}$ " x 1", Tray	Dozen	33.16	0.50	2	1.69
2308BB	8" x 5 $\frac{3}{4}$ " x $\frac{3}{4}$ ", Teriyaki Tray	Dozen	22.22	1	6	0.75
2309BB	9" x 6 $\frac{1}{2}$ " x $\frac{7}{8}$ ", Teriyaki Tray	Dozen	32.23	1	6	1.00
2311BB	23 oz, 10 $\frac{3}{4}$ " x 7 $\frac{7}{8}$ " x 1", Teriyaki Tray	Dozen	33.05	1	4	1.06



# Blue Bamboo

2023



5306BB



5307BB



5308BB



5309BB



5265BB



5275BB



5285BB

Item	Description	U/M	Weight Gross lbs	Inner Pack	Master Pack	Cu. Ft.
5306BB	21 oz, 6" Diameter x 2½" Height, Swirl Bowl	Dozen	29.10	1	6	1.29
5307BB	32 oz, 6¾" Diameter x 2¾" Height, Swirl Bowl	Dozen	37.48	1	6	1.58
5308BB	48 oz, 8" Diameter x 3⅛" Height, Swirl Bowl	Dozen	51.15	0.50	6	2.94
5309BB	72 oz, 9" Diameter x 3½" Height, Swirl Bowl	Dozen	37.92	0.50	3	2.16
5265BB	25 oz, 6¼" Diameter x 2¾" Height, Scalloped Bowl	Dozen	39.68	1	8	1.92
5275BB	34 oz, 7¼" Diameter x 3" Height, Scalloped Bowl	Dozen	40.79	1	6	1.82
5285BB	53 oz, 8¼" Diameter x 3½" Height, Scalloped Bowl	Dozen	60.63	0.50	6	3.60



5060BB



5065BB



5070BB



5075BB



5085BB



5095BB

Item	Description	U/M	Weight Gross lbs	Inner Pack	Master Pack	Cu. Ft.
5060BB	22 oz, 6⅞" Diameter x 2¼" Height, Rimless Bowl	Dozen	37.92	1	8	2.07
5065BB	32 oz, 7½" Diameter x 2½" Height, Rimless Bowl	Dozen	43.98	1	8	2.59
5070BB	36 oz, 8" Diameter x 2⅝" Height, Rimless Bowl	Dozen	41.45	1	6	2.10
5075BB	52 oz, 8¾" Diameter x 2⅞" Height, Rimless Bowl	Dozen	47.18	1	6	2.43
5085BB	70 oz, 9¾" Diameter x 3¼" Height, Rimless Bowl	Dozen	48.06	0.50	4	3.24
5095BB	96 oz, 11" Diameter x 3¾" Height, Rimless Bowl	Dozen	51.15	0.50	3	3.66

MELAMINE

131

# Blue Bamboo

MELAMINE



5106BB



5107BB



5108BB



5206BB



5207BB



5208BB



5008BB

Item	Description	U/M	Weight Gross lbs	Inner Pack	Master Pack	Cu. Ft.
5106BB	15 oz, 6" Diameter x 2" Height, Bowl	Dozen	39.24	1	12	1.76
5107BB	24 oz, 7" Diameter x 2¼" Height, Bowl	Dozen	39.68	1	8	1.46
5108BB	34 oz, 8" Diameter x 2½" Height, Bowl	Dozen	50.71	1	8	2.47
5206BB	25 oz, 5⅝" Diameter x 2⅞" Height, Rice Bowl	Dozen	26.46	1	6	1.35
5207BB	39 oz, 7" Diameter x 3¼" Height, Rice Bowl	Dozen	37.15	1	6	2.11
5208BB	56 oz, 8" Diameter x 3½" Height, Rice Bowl	Dozen	41.29	1	6	2.50
5008BB	35 oz, 8" Diameter x 2⅝" Height, Special Deep Bowl	Dozen	41.89	1	6	2.27



3001BB



3006BB



1035BB



3005BB



3540BB



3008BB



1036BB

Item	Description	U/M	Weight Gross lbs	Inner Pack	Master Pack	Cu. Ft.
3001BB	10 oz, 4½" Diameter x 1¾" Height, Bowl	Dozen	20.28	0.50	6	1.22
3006BB	9 oz, 4⅜" Diameter x 2½" Height, Rice Bowl	Dozen	50.26	1	24	3.70
1035BB	6 oz, 3⅝" x 3½" x 1⅞", Vegetable Dish	Dozen	41.40	2	16	2.07
3005BB	9 oz, 4¾" Diameter x 2" Height, Rice Bowl	Dozen	49.82	1	24	3.23
3540BB	8 oz, 4⅜" Diameter x 2⅞" Height, Saucer	Dozen	34.61	1	12	1.45
3008BB	6 oz, 3¾" Diameter x 2" Height, Rice Bowl	Dozen	42.99	2	24	1.79
1036BB	3 oz, 3⅝" Diameter x 1¾" Height, Dish	Dozen	27.46	2	24	1.14



3201BB (Bowl)  
(Lid & Bowl are sold separately)



3201CBB (Lid)



3502BB



3503BB



3504BB



3506BB

Item	Description	U/M	Weight Gross lbs	Inner Pack	Master Pack	Cu. Ft.
3201BB	20 oz, 5¼" Diameter x 3" Height, Noodle Bowl (Lid Sold Separately)	Dozen	29.76	1	6	1.19
3201CBB	5¼" Diameter, Lid only for 3201BB	Dozen	14.33	1	6	0.97
3502BB	9 oz, 4" Diameter x 3⅞" Height, Miso Bowl with Lid	Dozen	25.93	0.50	6	1.34
3503BB	12 oz, 4⅞" Diameter x 2⅞" Height, Soup Bowl with Lid	Dozen	32.63	0.50	6	3.14
3504BB	14 oz, 4¼" Diameter x 3⅞" Height, Chawanmushi Bowl with Lid	Dozen	34.17	0.50	6	3.69
3506BB	10 oz, 4½" Diameter x 2¼" Height, Rice Bowl with Lid	Dozen	27.56	0.50	6	1.58



9152BB



9302BB



3545BB



3501BB



102.8BB



0002BB



1338BB



1002BB



0001BB

Item	Description	U/M	Weight Gross lbs	Inner Pack	Master Pack	Cu. Ft.
9152BB	5 oz, 3⅞" Diameter x 2⅞" Height, Tea Cup	Dozen	54.67	1	30	2.94
9302BB	11 oz, 3½" Diameter x 3⅞" Height, Tea Cup	Dozen	46.30	1	10	2.96
3545BB	6 oz, 4½" Diameter x 2¼" Height, Saucer	Dozen	32.41	1	12	1.32
3501BB	7 oz, 4 ½" Diameter x 2⅞" Height, Sauce Bowl	Dozen	28.44	1	12	1.37
102.8BB	2 oz, 3½" Diameter x ⅝" Height, Sauce Dish	Dozen	64.77	5	80	1.89
0002BB	1½ oz, 3⅞" x 2¾" x 1⅞", Divided Sauce Dish	Dozen	27.34	1	18	1.35
1338BB	3¾" Diameter x ½" Height, Saucer	Dozen	60.85	5	50	1.65
1002BB	4 oz, 3⅞" x 3⅞" x 1½", Square Bowl	Dozen	31.31	1	20	1.63
0001BB	2 oz, 3½" x 2⅞" x 1", Sauce Dish	Dozen	39.68	2	40	1.41

# Blue Bamboo

MELAMINE



Item	Description	U/M	Weight Gross lbs	Inner Pack	Master Pack	Cu. Ft.
7001BB	1 oz, 7 <sup>3</sup> / <sub>8</sub> " x 2 <sup>1</sup> / <sub>2</sub> ", Soup Ladle	Dozen	33.07	5	40	2.08
7002BB	½ oz, 4 <sup>7</sup> / <sub>8</sub> " x 1 <sup>5</sup> / <sub>8</sub> ", Soup Spoon	Dozen	60.63	5	100	1.99
7003BB	¾ oz, 5 <sup>3</sup> / <sub>4</sub> " x 1 <sup>3</sup> / <sub>4</sub> ", Won Ton Soup Spoon	Dozen	52.58	5	100	2.26
7005BB	1 ½ oz, 8 <sup>1</sup> / <sub>4</sub> " x 2 <sup>3</sup> / <sub>4</sub> ", Rice Ladle	Dozen	48.50	2	30	2.38
7006BB	2 ½ oz, 10 <sup>1</sup> / <sub>4</sub> " x 3 <sup>3</sup> / <sub>8</sub> ", Soup Ladle	Dozen	41.89	2	30	3.85
7007BB	2 ½ oz, 8 <sup>3</sup> / <sub>4</sub> " x 2 <sup>3</sup> / <sub>4</sub> ", Ladle/Spoon	Dozen	44.78	2	30	2.55
7008BB	1 ½ oz, 9 <sup>1</sup> / <sub>4</sub> " x 3", Rice Ladle	Dozen	41.89	2	30	2.55
7009BB	12 <sup>1</sup> / <sub>2</sub> " x 2 <sup>1</sup> / <sub>2</sub> ", Spatula/Turner	Dozen	41.89	2	30	2.49



Item	Description	U/M	Weight Gross lbs	Inner Pack	Master Pack	Cu. Ft.
8004BB	13 oz, 9 <sup>1</sup> / <sub>2</sub> " x 4 <sup>1</sup> / <sub>2</sub> " x 1 <sup>3</sup> / <sub>4</sub> ", Sushi Boat	Dozen	17.11	0.50	4	1.70
8005BB	22 oz, 12" x 5 <sup>1</sup> / <sub>2</sub> " x 2 <sup>1</sup> / <sub>8</sub> ", Sushi Boat	Dozen	25.60	0.50	4	3.12
8006BB	54 oz, 16 <sup>1</sup> / <sub>4</sub> " x 7 <sup>1</sup> / <sub>8</sub> " x 2 <sup>5</sup> / <sub>8</sub> ", Sushi Boat	Dozen	27.34	0.50	2	2.98

**\*\*Rice Ladle and Soup Spoon are not NSF Certified.\*\***



# Gold Orchid



Lotus Shape Plate • Wavy  
Rectangular Plate • Mug • Soup  
Bowl • Dish Saucer • Plates



# Gold Orchid

MELAMINE



1806



1807



1808



1810



1812



1814



1816

Item	Description	U/M	Weight Gross lbs	Inner Pack	Master Pack	Cu. Ft.
1806	6" Diameter x 1" Height, Lotus Shape Plate	Dozen	31.79	1	6	0.96
1807	7 1/4" Diameter x 1 1/4" Height, Lotus Shape Plate	Dozen	34.96	0.50	4	1.39
1808	8 1/4" Diameter x 1 3/8" Height, Lotus Shape Plate	Dozen	24.52	0.50	2	0.95
1810	10 1/2" Diameter x 1 1/2" Height, Lotus Shape Plate	Dozen	35.19	0.50	2	1.55
1812	12" Diameter x 1 5/8" Height, Lotus Shape Plate	Dozen	36.42	0.50	2	1.81
1814	14" Diameter x 1 3/4" Height, Lotus Shape Plate	Dozen	25.04	0.25	1	1.79
1816	16" Diameter x 1 7/8" Height, Lotus Shape Plate	Dozen	37.06	0.25	1	2.39



1707



1708



1710



1712

Item	Description	U/M	Weight Gross lbs	Inner Pack	Master Pack	Cu. Ft.
1707	7 1/2" Diameter x 1 1/8" Height, Round Plate	Dozen	35.91	0.50	4	1.47
1708	8 1/4" Diameter x 1 1/4" Height, Round Plate	Dozen	23.94	0.50	2	0.93
1710	10 1/2" Diameter x 1 3/8" Height, Round Plate	Dozen	33.31	0.50	2	1.43
1712	11 3/4" Diameter x 1 1/2" Height, Round Plate	Dozen	39.44	0.50	2	1.77





2404



2406



2408



2412



2414



2416

Item	Description	U/M	Weight Gross lbs	Inner Pack	Master Pack	Cu. Ft.
2404	3 oz, 4" x 3¾" x 1⅛", Wavy Rectangular Sauce Dish	Dozen	34.24	1	12	0.90
2406	8 oz, 6¼" x 4¾" x 1⅛", Wavy Rectangular Plate	Dozen	33.33	1	6	0.89
2408	12 oz, 8½" x 5¾" x 1⅛", Wavy Rectangular Plate	Dozen	35.23	1	4	0.93
2412	11 ¼" x 7¼" x 1", Wavy Rectangular Plate	Dozen	26.50	0.50	3	1.48
2414	13½" x 9 ⅛" x 1⅜", Wavy Rectangular Plate	Dozen	40.34	0.50	3	2.40
2416	15½" x 10¾" x 1¾", Wavy Rectangular Plate	Dozen	46.19	0.50	2	2.86



3704



3706



3707



3708GD

Item	Description	U/M	Weight Gross lbs	Inner Pack	Master Pack	Cu. Ft.
3704	10 oz, 4½" Diameter x 2⅝" Height, Wavy Rice Bowl	Dozen	37.46	0.50	6	1.39
3706	12½ oz, 5" Diameter x 2⅝" Height, Wavy Rice Bowl	Dozen	37.10	0.50	5	1.57
3707	23 oz, 6½" Diameter x 2⅞" Height, Wavy Soup Bowl	Dozen	38.65	0.50	3	1.52
3708GD	38½ oz, 8" Diameter x 3⅞" Height, Wavy Soup Bowl	Dozen	33.84	0.50	2	1.87

# Gold Orchid

MELAMINE



5705



5706



5707

Item	Description	U/M	Weight Gross lbs	Inner Pack	Master Pack	Cu. Ft.
5705	11 oz, 4¾" Diameter x 2⅜" Height, Rice Bowl	Dozen	19.40	1	5	0.89
5706	16 oz, 6" Diameter x 2¾" Height, Soup Bowl	Dozen	29.17	0.50	4	1.38
5707	30 oz, 7½" Diameter x 3¼" Height, Soup Bowl	Dozen	26.19	0.50	2	1.34



5770



5780



3705

Item	Description	U/M	Weight Gross lbs	Inner Pack	Master Pack	Cu. Ft.
5770	24 oz, 6¾" Diameter x 2⅝" Height, Soup Bowl	Dozen	28.04	0.50	4	1.72
5780	32 oz, 7½" Diameter x 3⅜" Height, Soup Bowl	Dozen	31.68	0.50	3	2.09
3705	7 oz, 4¾" Diameter x 1¾" Height, Wavy Rice Bowl	Dozen	23.88	1	6	0.88



1903GD



1904GD



6602GD

Item	Description	U/M	Weight Gross lbs	Inner Pack	Master Pack	Cu. Ft.
1903GD	3 oz, 3½" Diameter x 1" Height, Flat Base Bowl	Dozen	18.50	1	12	1.07
1904GD	6 oz, 4½" Diameter x 1½" Height, Flat Base Bowl	Dozen	34.83	1	12	1.65
6602GD	3 oz, 4" Diameter x 1" Height, Hexagon Shape, Round Base Dish	Dozen	21.41	1	8	1.15



3601



3703



9753GD



1704

Item	Description	U/M	Weight Gross lbs	Inner Pack	Master Pack	Cu. Ft.
3601	5 oz, 4 7/8" x 4 1/4" x 2 1/4", Dip Bowl	Dozen	21.45	1	8	0.98
3703	2 oz, 3 1/4" Diameter x 1 1/2" Height, Dish Saucer	Dozen	30.16	1	12	1.08
9753GD	8 oz, 3 1/8" Diameter x 3 1/2" Height, Mug	Dozen	20.39	1	6	0.99
1704	4" Diameter x 1/2" Height, Round Plate	Dozen	18.12	1	8	0.46



1901GD



9752



3955GD



7003GD

Item	Description	U/M	Weight Gross lbs	Inner Pack	Master Pack	Cu. Ft.
1901GD	2 oz, 3 3/4" x 2 1/2" x 1", Rectangular Sauce Dish	Dozen	20.52	1	12	0.68
9752	4 oz, 3 1/4" Diameter x 2 1/8" Height, Mug	Dozen	21.63	1	6	0.73
3955GD	9 oz, 5 1/2" Diameter x 1 3/8" Height, Flat Base Bowl	Dozen	27.14	1	6	0.97
7003GD	3/4 oz, 5 5/8" x 1 5/8", Spoon	Dozen	52.58	5	100	2.26



\*\* Soup Spoon is not NSF Certified

# Tenmoku

MELAMINE

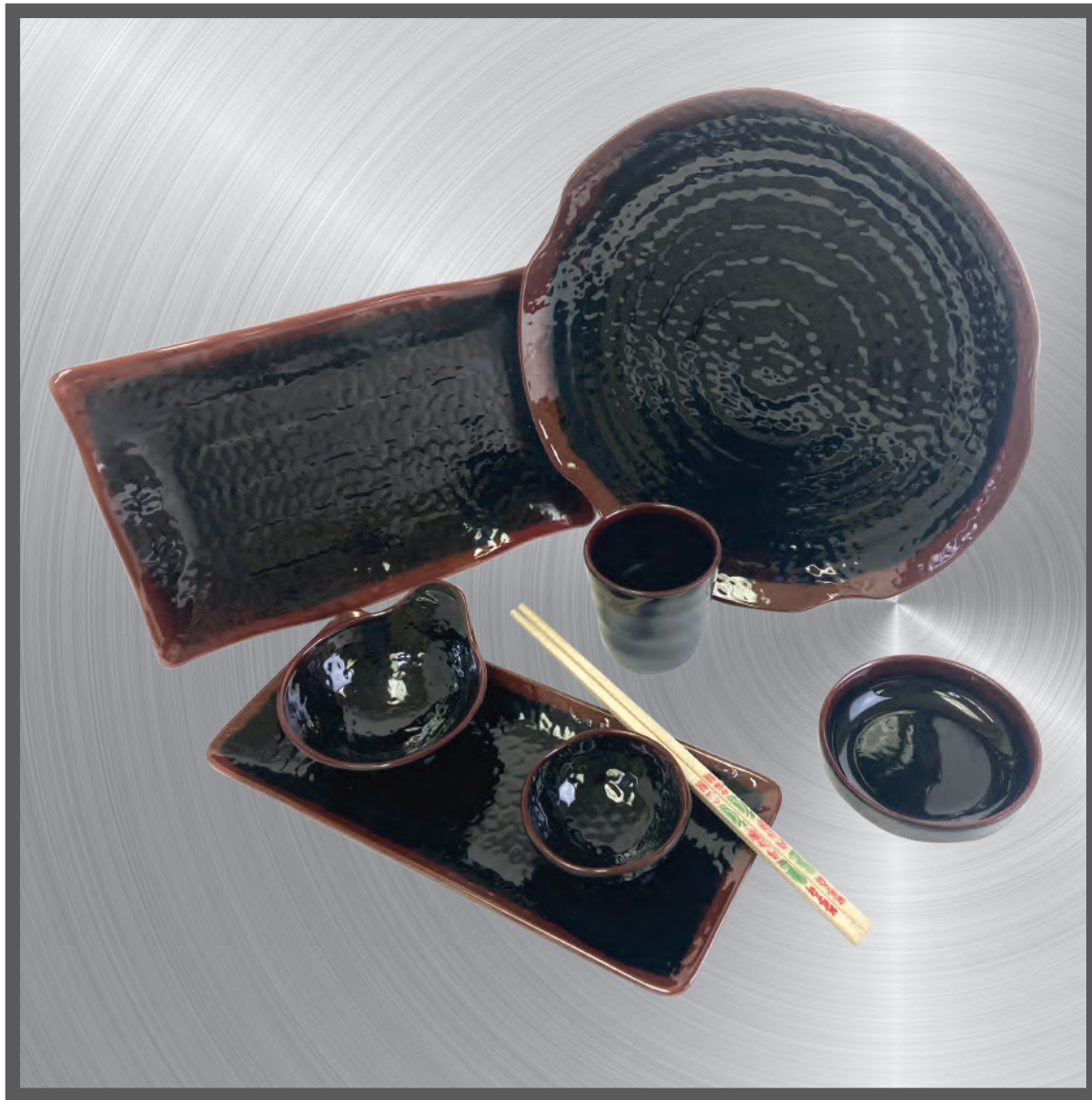

Dip Bowl • Rectangular Plate •  
Plate • Wavy Rice Bowl • Mug





Item	Description	U/M	Weight Gross lbs	Inner Pack	Master Pack	Cu. Ft.
1806TM	6" Diameter x 1" Height, Lotus Shape Plate	Dozen	31.79	1	6	0.96
1807TM	7¼" Diameter x 1¼" Height, Lotus Shape Plate	Dozen	34.96	0.50	4	1.39
1808TM	8¼" Diameter x 1¾" Height, Lotus Shape Plate	Dozen	24.52	0.50	2	0.95
1809TM	9¾" Diameter x 1¾" Height, Lotus Shape Plate	Dozen	27.95	0.50	2	1.10
1810TM	10½" Diameter x 1½" Height, Lotus Shape Plate	Dozen	35.19	0.50	2	1.55
1812TM	12" Diameter x 1½" Height, Lotus Shape Plate	Dozen	36.42	0.50	2	1.81
1814TM	14" Diameter x 1¾" Height, Lotus Shape Plate	Dozen	25.04	0.25	1	1.79
1816TM	16" Diameter x 1¾" Height, Lotus Shape Plate	Dozen	37.06	0.25	1	2.39

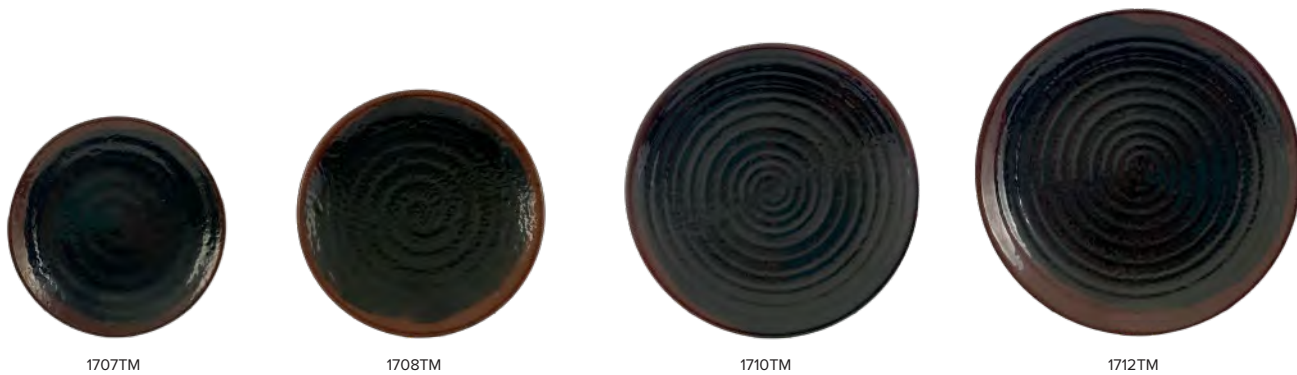

Item	Description	U/M	Weight Gross lbs	Inner Pack	Master Pack	Cu. Ft.
1707TM	7½" Diameter x 1½" Height, Round Plate	Dozen	35.91	0.50	4	1.47
1708TM	8¼" Diameter x 1¼" Height, Round Plate	Dozen	23.94	0.50	2	0.93
1710TM	10½" Diameter x 1¾" Height, Round Plate	Dozen	33.31	0.50	2	1.43
1712TM	11¾" Diameter x 1½" Height, Round Plate	Dozen	39.44	0.50	2	1.77

# Tenmoku



2414TM



2416TM

Item	Description	U/M	Weight Gross lbs	Inner Pack	Master Pack	Cu. Ft.
2414TM	13½" x 9½" x 1⅜", Wavy Rectangular Plate	Dozen	40.34	0.50	3	2.40
2416TM	15½" x 10¾" x 1¾", Wavy Rectangular Plate	Dozen	46.19	0.50	2	2.86



2406TM



2408TM

Item	Description	U/M	Weight Gross lbs	Inner Pack	Master Pack	Cu. Ft.
2406TM	8 oz, 6¼" x 4¾" x 1⅛", Wavy Rectangular Plate	Dozen	33.33	1	6	0.89
2408TM	12 oz, 8½" x 5¾" x 1⅛", Wavy Rectangular Plate	Dozen	35.23	1	4	0.93



2411TM



2412TM

Item	Description	U/M	Weight Gross lbs	Inner Pack	Master Pack	Cu. Ft.
2411TM	11¼" x 5" x 1", Rectangular Plate	Dozen	30.93	0.50	3	1.03
2412TM	11¼" x 7¼" x 1", Wavy Rectangular Plate	Dozen	26.50	0.50	3	1.48



3703TM



3704TM



3706TM



3707TM



3708TM

Item	Description	U/M	Weight Gross lbs	Inner Pack	Master Pack	Cu. Ft.
3703TM	2 oz, 3¼" Diameter x 1½" Height, Saucer Dish	Dozen	30.16	1	12	1.08
3704TM	10 oz, 4½" Diameter x 2⅝" Height, Wavy Rice Bowl	Dozen	37.46	0.50	6	1.39
3706TM	12½ oz, 5" Diameter x 2⅝" Height, Wavy Rice Bowl	Dozen	37.10	0.50	5	1.57
3707TM	23 oz, 6½" Diameter x 2⅝" Height, Wavy Soup Bowl	Dozen	38.65	0.50	3	1.52
3708TM	38½ oz, 8" Diameter x 3⅝" Height, Wavy Soup Bowl	Dozen	33.84	0.50	2	1.87



3705TM



5705TM



5706TM

Item	Description	U/M	Weight Gross lbs	Inner Pack	Master Pack	Cu. Ft.
3705TM	7 oz, 4¾" Diameter x 1¾" Height, Wavy Rice Bowl	Dozen	23.88	1	6	0.88
5705TM	11 oz, 4¾" Diameter x 2⅝" Height, Rice Bowl	Dozen	19.40	1	5	0.89
5706TM	16 oz, 6" Diameter x 2¾" Height, Soup Bowl	Dozen	29.17	0.50	4	1.38



5707TM



5770TM



5780TM



5765TM

Item	Description	U/M	Weight Gross lbs	Inner Pack	Master Pack	Cu. Ft.
5707TM	30 oz, 7½" Diameter x 3¼" Height, Soup Bowl	Dozen	26.19	0.50	2	1.34
5770TM	24 oz, 6¾" Diameter x 2⅝" Height, Soup Bowl	Dozen	28.04	0.50	4	1.72
5780TM	32 oz, 7½" Diameter x 3⅝" Height, Soup Bowl	Dozen	34.33	0.50	3	2.09
5765TM	32 oz, 6¾" Diameter x 3⅝" Height, Soup Bowl	Dozen	30.45	0.50	3	1.44

# Tenmoku



**3601TM • Dip Bowl**  
Enlarged to show detail



1903TM



1904TM



9752TM



9753TM



3601TM



3955TM

Item	Description	U/M	Weight Gross lbs	Inner Pack	Master Pack	Cu. Ft.
1903TM	3 oz, 3½" Diameter x 1" Height, Flat Base Bowl	Dozen	18.50	1	12	1.07
1904TM	6 oz, 4½" Diameter x 1½" Height, Flat Base Bowl	Dozen	34.83	1	12	1.65
9752TM	4 oz, 3¼" Diameter x 2½" Height, Mug	Dozen	21.63	1	6	0.73
9753TM	8 oz, 3½" Diameter x 3½" Height, Mug	Dozen	20.39	1	6	0.99
3601TM	5 oz, 4⅞" x 4¼" x 2¼", Dip Bowl	Dozen	21.45	1	8	0.98
3955TM	9 oz, 5½" Diameter x 1¾" Height, Flat Base Bowl	Dozen	27.14	1	6	0.97



**2404TM • Wavy Sauce Dish**  
Enlarged to show detail



1901TM



1902TM



1703TM



1704TM



2404TM

Item	Description	U/M	Weight Gross lbs	Inner Pack	Master Pack	Cu. Ft.
1901TM	2 oz, 3¾" x 2½" x 1", Rectangular Sauce Dish	Dozen	20.52	1	12	0.68
1902TM	4 oz, 6" x 3" x ⅞", Twin Sauce Dish	Dozen	28.26	1	12	1.17
1703TM	2 oz, 3½" Diameter x ⅝" Height, Sauce Dish	Dozen	25.62	1	16	0.82
1704TM	4" Diameter x ½" Height, Round Plate	Dozen	18.12	1	8	0.46
2404TM	3 oz, 4" x 3¾" x 1½", Wavy Sauce Dish	Dozen	34.24	1	12	0.90



# Two Tone



Rice Spoons • Sauce Dish • Miso  
Soup Bowl • Lids • Soba Bowls



# Two Tone



**7003JBR • Rice Spoon**  
Enlarged to show detail



7003JBR



7200JBR



7100JBR

Item	Description	U/M	Weight Gross lbs	Inner Pack	Master Pack	Cu. Ft.
7003JBR	¾ oz, 5¾" x 1¾", Rice Spoon	Dozen	52.58	5	60	2.26
7100JBR	10 oz, 6¼" x 1¾", Soba Spoon	Dozen	45.48	5	60	2.21
7200JBR	0.6 oz, 6" x 1¾", Soup Spoon	Dozen	37.93	5	60	1.74



1101JBR



5560JBR



5565JBR



5570JBR



**5560JBR • Donburi/ Soba Bowl**  
Enlarged to show detail



3221JBR



3222JBR



3223JBR



5185JBR

Item	Description	U/M	Weight Gross lbs	Inner Pack	Master Pack	Cu. Ft.
1101JBR	1 oz, 2¾" Diameter x ½" Height, Sauce Dish	Dozen	45.08	5	80	1.15
5560JBR	24 oz, 6 ⅛" Diameter x 3⅝" Height, Donburi/Soba Bowl	Dozen	32.67	1	6	1.70
5565JBR	28 oz, 6 ½" Diameter x 3¼" Height, Donburi/Soba Bowl	Dozen	38.06	1	6	1.95
5570JBR	38 oz, 7" Diameter x 3⅝" Height, Donburi/Soba Bowl	Dozen	43.74	1	6	2.30
3221JBR	8 oz, 4" Diameter x 2¾" Height (Lid: 3⅝" Diameter x 1¼" Height)	Dozen	26.82	1	6	1.50
3222JBR	10 oz, 4 ¾" Diameter x 2¼" Height (Lid: 4¼" Diameter x 1¼" Height)	Dozen	28.73	1	6	1.47
3223JBR	16 oz, 6" Diameter x 3" Height (Lid: 5½" Diameter x 1½" Height)	Dozen	39.82	1	5	2.26
5185JBR	42 oz, 8½" Diameter x 3¼" Height, Soba Noodle Bowl	Dozen	39.60	1	4	3.14

\*\* Spoons are not NSF Certified



# Urushi Spray



Tempura Plate • Tea Cup •  
Dessert Bowl • Saucer • Sake Cup  
• Salad Bowl



# Urushi Spray



**SP3008BN • Appetizer Bowl**  
Enlarged to show detail



SP1009BN



SP3008BN



SP3010BN



SP3016BN



SP3208BN



SP5009BN



SP5012BN



SP5108BN

Item	Description	U/M	Weight Gross lbs	Inner Pack	Master Pack	Cu. Ft.
SP1009BN	36 oz, 9" Diameter x 2" Height, Tempura Plate	Dozen	32.76	1	3	1.42
SP3008BN	8 oz, 4¼" Diameter x 1¾" Height, Appetizer Bowl	Dozen	28.14	1	10	1.38
SP3010BN	10 oz, 6½" Diameter x 1⅞" Height, Salad Bowl	Dozen	46.60	1	10	2.29
SP3016BN	16 oz, 5¾" Diameter x 2⅞" Height, Salad Bowl	Dozen	47.47	1	10	3.20
SP3208BN	8 oz, 4¼" Diameter x 2½" Height, Dessert Bowl	Dozen	26.62	1	10	1.22
SP5009BN	9 oz, 4½" Diameter x 2" Height, Rice Bowl	Dozen	33.91	1	10	1.83
SP5012BN	12 oz, 5" Diameter x 2½" Height, Rice Bowl	Dozen	38.34	1	10	2.15
SP5108BN	8 oz, 4¾" Diameter x 2" Height, Miso Soup Bowl	Dozen	22.94	1	10	1.44



**SP9040BN • Tea Cup**  
Enlarged to show detail



SP9015BN



SP9020BN



SP3002BN



SP9040BN

Item	Description	U/M	Weight Gross lbs	Inner Pack	Master Pack	Cu. Ft.
SP9015BN	1½ oz, 2¼" Diameter x 1½" Height, Sake Wine Cup	Dozen	38.20	1	24	1.64
SP9020BN	2 oz, 2½" Diameter x 2" Height, Sake Wine Cup	Dozen	27.41	1	24	1.64
SP3002BN	2 oz, 3" Diameter x 1¼" Height, Saucer	Dozen	28.99	2	24	1.48
SP9040BN	4 oz, 2¾" Diameter x 3⅞" Height, Tea Cup	Dozen	42.98	1	12	1.98

# Wei



Plates • Sauce Bowl • Noodle Bowl  
• Sushi Boat • Soup Spoon



# Wei



Item	Description	U/M	Weight Gross lbs	Inner Pack	Master Pack	Cu. Ft.
1006J	6" Diameter x 1/2" Height, Round Plate	Dozen	60.63	1	24	1.96
1007J	6 7/8" Diameter x 3/4" Height, Round Plate	Dozen	46.03	1	16	1.69
1008J	7 7/8" Diameter x 5/8" Height, Round Plate	Dozen	55.12	1	12	1.86
1009J	9 1/8" Diameter x 3/4" Height, Round Plate	Dozen	49.71	1	8	1.66
1010J	10 3/8" Diameter x 7/8" Height, Round Plate	Dozen	39.48	1	6	1.69
1012J	11 3/4" Diameter x 7/8" Height, Round Plate	Dozen	44.25	1	4	1.62
1014J	14 1/8" Diameter x 1 1/8" Height, Round Plate	Dozen	51.81	0.50	3	2.22



Item	Description	U/M	Weight Gross lbs	Inner Pack	Master Pack	Cu. Ft.
1206J	6" Diameter x 3/4" Height, Curved Rim Plate	Dozen	47.40	1	18	1.63
1207J	7" Diameter x 1" Height, Curved Rim Plate	Dozen	60.19	1	16	2.20
1208J	8" Diameter x 1 1/8" Height, Curved Rim Plate	Dozen	55.56	1	12	2.19
1209J	9 1/4" Diameter x 1 1/8" Height, Curved Rim Plate	Dozen	52.47	1	8	2.17
1210J	10 1/2" Diameter x 1 3/8" Height, Curved Rim Plate	Dozen	50.71	1	6	2.33
1350J	5 1/8" Diameter x 1 1/8" Height, Soup Plate	Dozen	27.56	1	12	1.41
1360J	5 7/8" Diameter x 3/4" Height, Plate	Dozen	38.80	1	12	2.53
1365J	6 1/2" Diameter x 1 1/8" Height, Soup Plate	Dozen	40.12	1	12	2.15





Item	Description	U/M	Weight Gross lbs	Inner Pack	Master Pack	Cu. Ft.
1304J	4¾" Diameter x ⅝" Height, Dinner Plate	Dozen	36.16	1	24	1.42
1305J	5¼" Diameter x ¾" Height, Dinner Plate	Dozen	44.09	1	24	2.00
1306J	6⅝" Diameter x ¾" Height, Dinner Plate	Dozen	34.17	1	12	1.57
1307J	7⅜" Diameter x 1" Height, Dinner Plate	Dozen	31.53	1	8	1.47
1308J	8⅝" Diameter x 1⅝" Height, Dinner Plate	Dozen	24.25	1	4	1.13



Item	Description	U/M	Weight Gross lbs	Inner Pack	Master Pack	Cu. Ft.
2008J	8" x 6" x ⅝", Platter	Dozen	54.01	1	16	2.65
2009J	9" x 6⅝" x ¾", Platter	Dozen	41.23	1	10	1.84
2010J	9⅞" x 7¼" x ¾", Platter	Dozen	50.86	1	8	1.90
2012J	12" x 8⅝" x 7⁄8", Platter	Dozen	48.50	1	6	2.06



Item	Description	U/M	Weight Gross lbs	Inner Pack	Master Pack	Cu. Ft.
1501J	8½" x 3¾" x 1", Vegetable Serving Plate	Dozen	28.66	1	6	1.06
1502J	9⅝" x 4¼" x 1", Rectangular Barbecue Plate	Dozen	68.56	1	12	3.01
1201J	4¾" x 4¼" x 1⅝", Plate	Dozen	29.83	1	12	0.89
1202J	5½" x 4¾" x ¾", Plate	Dozen	37.43	1	12	1.30
1504J	6¾" x 4½" x 1⅝", Barbecue Plate	Dozen	39.68	1	12	1.86
1505J	8¼" x 5⅝" x 1", Barbecue Plate	Dozen	48.50	1	8	2.09
1535J	5¼" x 3¼" x ¾", Plate	Dozen	31.53	1	12	1.24

# Wei



0011J



0900J



1203J



0010J



1607J



1608J



1609J



1503J

Item	Description	U/M	Weight Gross lbs	Inner Pack	Master Pack	Cu. Ft.
0011J	8½" x 4¾" x 1⅛", Bamboo Sashimi Platter	Dozen	37.63	1	6	1.88
0900J	13½" x 4½" x ⅝", Sandwich Tray	Dozen	53.57	1	8	2.24
1203J	6" x 5½" x ¾", Oblong Platter	Dozen	36.38	1	12	1.26
0010J	6½" x 5½" x 1⅛", Plate	Dozen	35.71	1	6	1.19
1607J	2 oz, 4" x 2¾" x ⅞", Wavy Shape Sauce Dish	Dozen	33.29	1	24	1.35
1608J	5¾" x 4" x ¾", Wavy Shape Barbecue Plate	Dozen	31.08	1	12	1.18
1609J	8½" x 5½" x ⅞", Wavy Shape Barbecue Plate	Dozen	28.66	1	6	1.15
1503J	6¾" x 4½" x 1", Bamboo Plate	Dozen	44.09	1	12	1.87



2308



2309



2311



0901J



0902J



0903J

Item	Description	U/M	Weight Gross lbs	Inner Pack	Master Pack	Cu. Ft.
2308	8" x 5¾" x ¾", Teriyaki Tray	Dozen	22.22	1	6	0.75
2309	9" x 6½" x ⅞", Teriyaki Tray	Dozen	32.23	1	6	1.00
2311	23 oz, 10¾" x 7⅞" x 1", Teriyaki Tray	Dozen	33.05	1	4	1.06
0901J	13½" x 10¼" x ¾", Tray	Dozen	19.00	0.50	2	0.96
0902J	15¼" x 11½" x ⅞", Tray	Dozen	24.54	0.50	2	1.34
0903J	17" x 12⅝" x 1", Tray	Dozen	33.16	0.50	2	1.69







5060J



5065J



5070J



5075J



5085J



5095J

Item	Description	U/M	Weight Gross lbs	Inner Pack	Master Pack	Cu. Ft.
5060J	22 oz, 6 $\frac{7}{8}$ " Diameter x 2 $\frac{1}{4}$ " Height, Rimless Bowl	Dozen	37.92	1	8	2.07
5065J	32 oz, 7 $\frac{1}{2}$ " Diameter x 2 $\frac{1}{2}$ " Height, Rimless Bowl	Dozen	43.98	1	8	2.59
5070J	36 oz, 8" Diameter x 2 $\frac{5}{8}$ " Height, Rimless Bowl	Dozen	41.45	1	6	2.10
5075J	52 oz, 8 $\frac{3}{4}$ " Diameter x 2 $\frac{7}{8}$ " Height, Rimless Bowl	Dozen	47.18	1	6	2.43
5085J	70 oz, 9 $\frac{3}{4}$ " Diameter x 3 $\frac{1}{4}$ " Height, Rimless Bowl	Dozen	48.06	0.50	4	3.24
5095J	96 oz, 11" Diameter x 3 $\frac{3}{4}$ " Height, Rimless Bowl	Dozen	51.15	0.50	3	3.66



5206J



5207J



5208J



5306J



5307J



5308J



5309J

Item	Description	U/M	Weight Gross lbs	Inner Pack	Master Pack	Cu. Ft.
5206J	25 oz, 5 $\frac{7}{8}$ " Diameter x 2 $\frac{7}{8}$ " Height, Rice Bowl	Dozen	26.46	1	6	1.35
5207J	39 oz, 7" Diameter x 3 $\frac{1}{4}$ " Height, Rice Bowl	Dozen	37.15	1	6	2.11
5208J	56 oz, 8" Diameter x 3 $\frac{1}{2}$ " Height, Rice Bowl	Dozen	41.29	1	6	2.50
5306J	21 oz, 6" Diameter x 2 $\frac{1}{2}$ " Height, Swirl Bowl	Dozen	29.10	1	6	1.29
5307J	32 oz, 6 $\frac{7}{8}$ " Diameter x 2 $\frac{3}{4}$ " Height, Swirl Bowl	Dozen	37.48	1	6	1.58
5308J	48 oz, 8" Diameter x 3 $\frac{1}{8}$ " Height, Swirl Bowl	Dozen	51.15	0.50	6	2.94
5309J	72 oz, 9" Diameter x 3 $\frac{1}{2}$ " Height, Swirl Bowl	Dozen	37.92	0.50	3	2.16

# Wei

MELAMINE



5265J



5275J



5285J



5106J



5107J



5108J



5008J

Item	Description	U/M	Weight Gross lbs	Inner Pack	Master Pack	Cu. Ft.
5265J	25 oz, 6¼" Diameter x 2¾" Height, Scalloped Bowl	Dozen	39.68	1	8	1.92
5275J	34 oz, 7¼" Diameter x 3" Height, Scalloped Bowl	Dozen	40.79	1	6	1.82
5285J	53 oz, 8¼" Diameter x 3½" Height, Scalloped Bowl	Dozen	60.63	0.50	6	3.60
5106J	15 oz, 6" Diameter x 2⅝" Height, Bowl	Dozen	39.24	1	12	1.76
5107J	24 oz, 7" Diameter x 2¼" Height, Bowl	Dozen	39.68	1	8	1.46
5108J	34 oz, 8" Diameter x 2½" Height, Bowl	Dozen	50.71	1	8	2.47
5008J	35 oz, 8" Diameter x 2⅝" Height, Special Deep Bowl	Dozen	41.89	1	6	2.27



3504J



3506J



3502J



3201J (Bowl)  
(Lid & Bowl are sold separately)



3201CJ



3503J



3540J

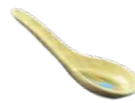

7002J



7003J



7100J

Item	Description	U/M	Weight Gross lbs	Inner Pack	Master Pack	Cu. Ft.
3504J	14 oz, 4¼" Diameter x 3⅝" Height, Chawanmushi Bowl with Lid	Dozen	34.17	0.50	6	3.69
3506J	10 oz, 4½" Diameter x 2¼" Height, Rice Bowl with Lid	Dozen	27.56	0.50	6	1.58
3502J	9 oz, 4" Diameter x 3⅞" Height, Miso Bowl with Lid	Dozen	25.93	0.50	6	1.34
3201J	20 oz, 5¾" Diameter x 3" Height, Noodle Bowl (Lid Sold Separately)	Dozen	29.76	1	6	1.19
3201CJ	5¼" Diameter, Lid Only for 3201J	Dozen	14.33	1	6	0.97
3503J	12 oz, 4⅞" Diameter x 2⅞" Height, Soup Bowl with Lid	Dozen	32.63	0.50	6	3.14
3540J	8 oz, 4⅜" Diameter x 2⅞" Height, Saucer	Dozen	34.61	1	12	1.45
7002J	½ oz, 4⅞" x 1⅝", Soup Spoon	Dozen	60.63	5	100	1.99
7003J	¾ oz, 5¾" x 1¾", Won Ton Soup Spoon	Dozen	52.58	5	100	2.26
7100J	1 oz, 6¼" x 1¾", Soup Spoon	Dozen	45.48	5	60	2.21

**\*\*Soup Spoon are not NSF Certified.\*\***



3001J



3005J



3006J



3008J

Item	Description	U/M	Weight Gross lbs	Inner Pack	Master Pack	Cu. Ft.
3001J	10 oz, 4½" Diameter x 1¾" Height, Bowl	Dozen	20.28	0.50	6	1.22
3005J	9 oz, 4¾" Diameter x 2" Height, Rice Bowl	Dozen	49.82	1	24	3.23
3006J	9 oz, 4¾" Diameter x 2½" Height, Rice Bowl	Dozen	50.26	1	24	3.70
3008J	6 oz, 3¾" Diameter x 2" Height, Rice Bowl	Dozen	42.99	2	24	1.79



0002J



1035J



1036J



9152J



9302J



0001J



1002J



1338J



1338J



3545J



3501J

Item	Description	U/M	Weight Gross lbs	Inner Pack	Master Pack	Cu. Ft.
0002J	1½ oz, 3⅝" x 2¾" x 1⅝", Divided Sauce Dish	Dozen	27.34	1	18	1.35
1035J	6 oz, 3⅝" x 3½" x 1⅝", Vegetable Dish	Dozen	41.40	2	16	2.07
1036J	3 oz, 3⅝" Diameter x 1¾" Height, Dish	Dozen	27.46	2	24	1.14
9152J	5 oz, 3⅝" Diameter x 2½" Height, Tea Cup	Dozen	54.67	1	30	2.94
9302J	11 oz, 3½" Diameter x 3⅝" Height, Tea Cup	Dozen	46.30	1	10	2.96
0001J	2 oz, 3½" x 2⅝" x 1", Sauce Dish	Dozen	39.68	2	40	1.41
1002J	4 oz, 3⅝" x 3⅝" x 1½", Square Bowl	Dozen	31.31	1	20	1.63
102.8J	2 oz, 3½" Diameter x ¾" Height, Sauce Dish	Dozen	64.77	5	80	1.89
1338J	3¾" Diameter x ½" Height, Saucer	Dozen	60.85	5	50	1.65
3545J	6 oz, 4½" Diameter x 2¼" Height, Saucer	Dozen	32.41	1	12	1.32
3501J	7 oz, 4½" Diameter x 2½" Height, Sauce Bowl	Dozen	28.44	1	12	1.37



8004J



8005J



8006J

Item	Description	U/M	Weight Gross lbs	Inner Pack	Master Pack	Cu. Ft.
8004J	13 oz, 9½" x 4½" x 1¾", Sushi Boat	Dozen	17.11	0.50	4	1.70
8005J	22 oz, 12" x 5½" x 2½", Sushi Boat	Dozen	25.60	0.50	4	3.12
8006J	54 oz, 16¼" x 7⅝" x 2⅝", Sushi Boat	Dozen	27.34	0.50	2	2.98

# Blue Jade

MELAMINE

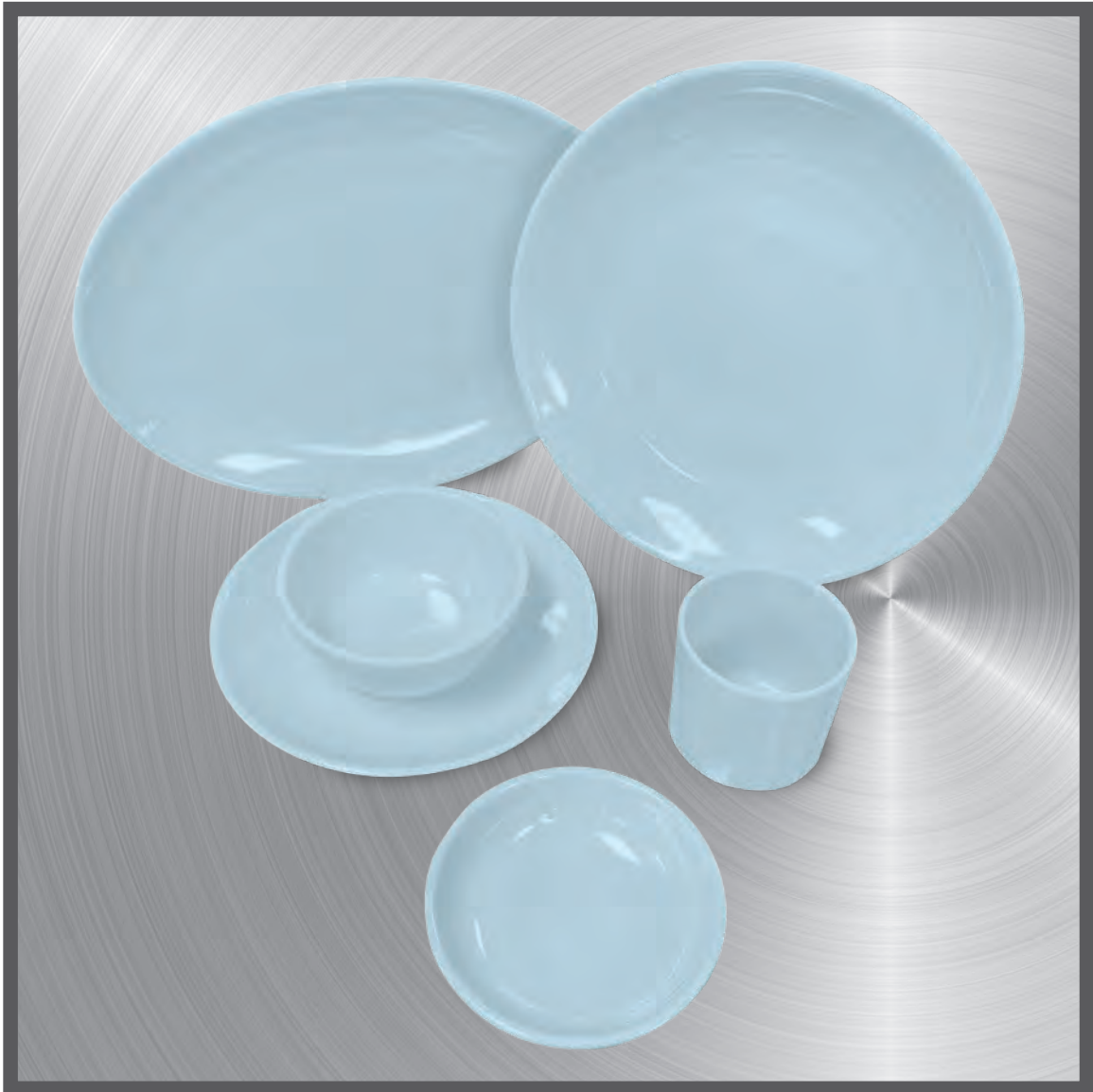

Plates • Platter • Flat Bowl  
Sauce Dish • Mug





Item	Description	U/M	Weight Gross lbs	Inner Pack	Master Pack	Cu. Ft.
1907	7 $\frac{1}{8}$ " Diameter x 1" Height, Round Plate	Dozen	31.08	1	6	1.24
1908	8 $\frac{7}{8}$ " Diameter x 1 $\frac{1}{4}$ " Height, Round Plate	Dozen	37.35	0.50	4	1.87
1909	9 $\frac{1}{4}$ " Diameter x 1 $\frac{1}{4}$ " Height, Round Plate	Dozen	35.63	1	4	1.42
1910	9 $\frac{3}{4}$ " Diameter x 1 $\frac{3}{8}$ " Height, Round Plate	Dozen	37.24	0.50	3	1.83
1911	10 $\frac{3}{4}$ " Diameter x 1 $\frac{5}{8}$ " Height, Round Plate	Dozen	29.61	0.50	2	1.38
1912	12" Diameter x 1 $\frac{3}{8}$ " Height, Round Plate	Dozen	30.38	1	2	1.28
1913	13" Diameter x 1 $\frac{3}{4}$ " Height, Round Plate	Dozen	37.06	0.50	2	2.06
1914	13 $\frac{3}{4}$ " Diameter x 1 $\frac{3}{8}$ " Height, Round Plate	Dozen	39.37	0.50	2	2.08
1916	15 $\frac{3}{4}$ " Diameter x 1 $\frac{7}{8}$ " Height, Round Plate	Dozen	36.49	0.25	1	2.31
1915	14" Diameter x 1 $\frac{3}{4}$ " Height, Narrow Rim Round Plate	Dozen	26.76	0.50	1	1.39

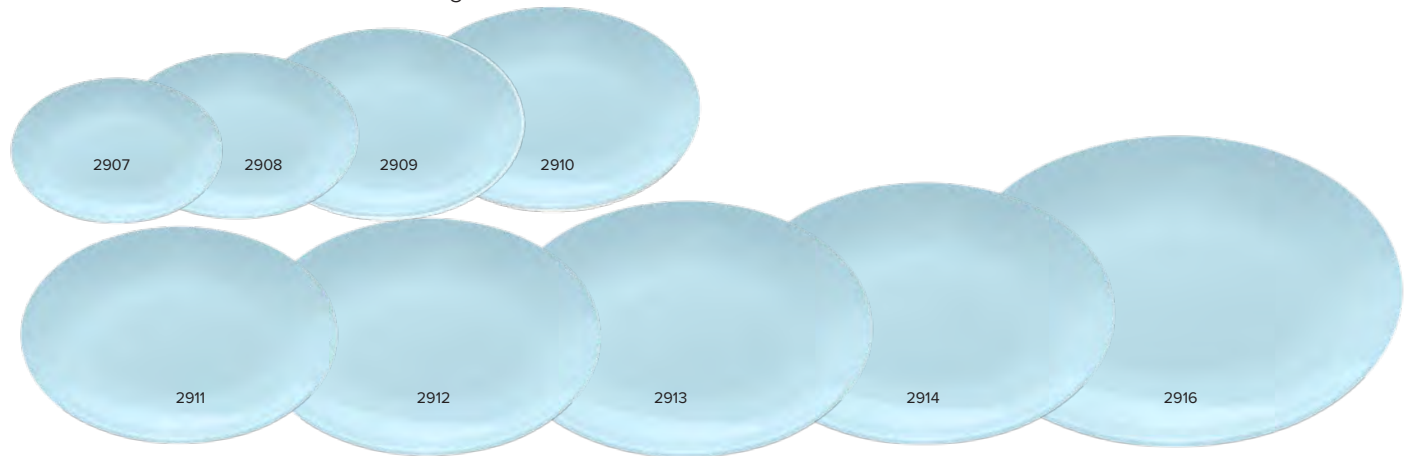

Item	Description	U/M	Weight Gross lbs	Inner Pack	Master Pack	Cu. Ft.
2907	7 $\frac{1}{8}$ " x 5" x $\frac{3}{4}$ ", Platter	Dozen	30.98	1	8	0.92
2908	8 $\frac{1}{8}$ " x 5 $\frac{3}{8}$ " x $\frac{3}{4}$ ", Platter	Dozen	25.33	1	6	0.89
2909	9 $\frac{1}{4}$ " x 6 $\frac{3}{4}$ " x $\frac{7}{8}$ ", Platter	Dozen	32.12	1	6	1.10
2910	10 $\frac{1}{4}$ " x 7 $\frac{1}{2}$ " x $\frac{7}{8}$ ", Platter	Dozen	30.80	1	4	1.06
2911	11 $\frac{1}{4}$ " x 8 $\frac{3}{8}$ " x $\frac{7}{8}$ ", Platter	Dozen	31.44	0.50	3	1.17
2912	12 $\frac{1}{2}$ " x 9 $\frac{1}{4}$ " x 1 $\frac{1}{8}$ ", Platter	Dozen	39.88	1	4	1.69
2913	13" x 9 $\frac{1}{2}$ " x 1 $\frac{1}{8}$ ", Platter	Dozen	27.07	0.50	2	1.19
2914	13 $\frac{1}{8}$ " x 10 $\frac{3}{8}$ " x 1 $\frac{1}{8}$ ", Platter	Dozen	28.33	0.50	2	1.35
2916	16" x 11 $\frac{3}{4}$ " x 1 $\frac{1}{4}$ ", Platter	Dozen	44.62	0.50	2	1.82

# Blue Jade



5975



5980



5990



3945



3955



3960



3965



1960

Item	Description	U/M	Weight Gross lbs	Inner Pack	Master Pack	Cu. Ft.
5975	42 oz, 7½" Diameter x 2⅞" Height, Bowl	Dozen	32.85	0.50	3	1.92
5980	54 oz, 8¼" Diameter x 3⅜" Height, Soup Bowl	Dozen	38.60	0.50	3	2.39
5990	74 oz, 9¼" Diameter x 3⅜" Height, Soup Bowl	Dozen	46.43	0.50	3	3.19
3945	6 oz, 4½" Diameter x 1¼" Height, Sauce Dish	Dozen	22.31	1	8	0.83
3955	9 oz, 5½" Diameter x 1⅜" Height, Bowl	Dozen	26.17	1	6	0.97
3960	12 oz, 6" Diameter x 1⅜" Height, Bowl	Dozen	21.32	1	4	0.88
3965	15 oz, 6½" Diameter x 1½" Height, Bowl	Dozen	26.28	0.50	4	1.19
1960	19 oz, 5¾" Diameter x 2" Height, Bowl	Dozen	20.61	0.50	4	1.66



3904



3905



3906



3935



5904



9154



9952



1903



1904



1905



1906



1945



1901



1902



1940

Item	Description	U/M	Weight Gross lbs	Inner Pack	Master Pack	Cu. Ft.
3904	8 oz, 4½" Diameter x 1⅞" Height, Bowl	Dozen	30.23	1	8	1.32
3905	12 oz, 5" Diameter x 2" Height, Bowl	Dozen	34.99	1	8	1.62
3906	18 oz, 6" Diameter x 2⅞" Height, Bowl	Dozen	26.41	0.50	4	1.36
3935	3 oz, 3¾" Diameter x 1⅞" Height, Sauce Dish	Dozen	22.05	2	12	0.79
5904	7 oz, 4" Diameter x 1⅞" Height, Bowl	Dozen	25.49	1	8	0.95
9154	8 oz, 3⅞" Diameter x 3⅞" Height, Tea Cup	Dozen	38.28	1	10	3.01
9952	9 oz, 2⅞" Diameter x 3¼" Height, Mug	Dozen	23.41	1	8	1.89
1903	3 oz, 3½" Diameter x 1" Height, Flat Base Bowl	Dozen	18.50	1	12	1.07
1904	6 oz, 4½" Diameter x 1⅞" Height, Flat Base Bowl	Dozen	34.83	1	12	1.58
1905	8 oz, 5½" Diameter x 1¼" Height, Flat Base Bowl	Dozen	45.77	1	12	2.53
1906	14 oz, 6" Diameter x 1⅜" Height, Flat Base Bowl	Dozen	18.58	1	4	1.15
1945	10 oz, 4½" Diameter x 2⅞" Height, Bowl	Dozen	34.13	1	12	1.42
1901	2 oz, 3¾" x 2½" x 1", Sauce Dish	Dozen	20.52	1	12	0.68
1902	4 oz, 6" x 3" x ⅞", Twin Sauce Dish	Dozen	28.26	1	12	1.17
1940	7 oz, 4" Diameter x 1⅞" Height, Sauce Dish	Dozen	19.62	1	6	1.14



# Ramekin



Salsa Dishes • Fluted Ramekins •  
Smooth Ramekins



### MELAMINE RAMEKINS, BONE

Ramekins are perfect for containing dipping sauces, small appetizers, and any small side dishes to accompany a meal.

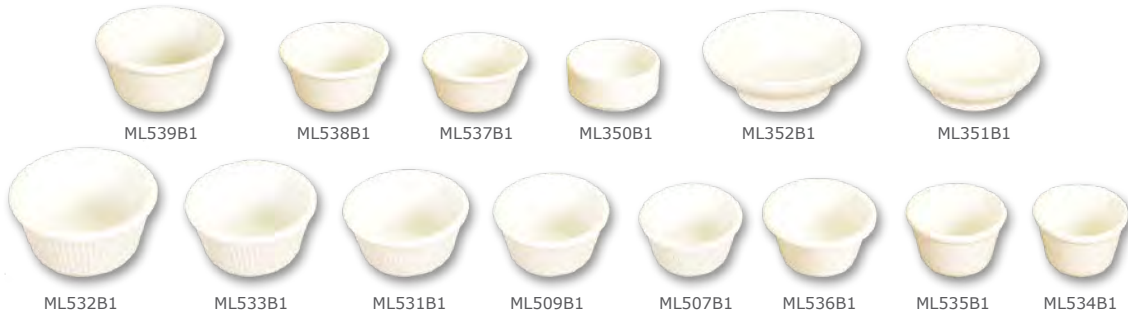

ITEM	DESCRIPTION	U/M	WEIGHT GROSS lbs	INNER PACK	MASTER PACK	CU. FT.
ML350B1	2 oz, 2 <sup>7</sup> / <sub>8</sub> " Smooth Ramekin (Heavy Duty), Bone	DOZEN	49.19	1	24	2.50
ML351B1	4 <sup>1</sup> / <sub>2</sub> oz, 4" Salsa Dish, Bone	DOZEN	23.10	1	12	1.08
ML352B1	8 oz, 4 <sup>3</sup> / <sub>4</sub> " Salsa Dish, Bone	DOZEN	28.97	1	12	1.43
ML507B1	1 <sup>1</sup> / <sub>2</sub> oz, 2 <sup>1</sup> / <sub>2</sub> " Fluted Ramekin, Bone	DOZEN	55.26	1	48	2.81
ML509B1	2 oz, 2 <sup>7</sup> / <sub>8</sub> " Fluted Ramekin, Bone	DOZEN	70.44	1	48	3.64
ML531B1	3 oz, 3 <sup>1</sup> / <sub>8</sub> " Fluted Ramekin, Bone	DOZEN	44.88	1	24	2.19
ML532B1	4 oz, 3 <sup>3</sup> / <sub>8</sub> " Fluted Ramekin, Bone	DOZEN	54.19	1	24	2.73
ML533B1	3 <sup>1</sup> / <sub>2</sub> oz, 3 <sup>3</sup> / <sub>8</sub> " Fluted Ramekin, Bone	DOZEN	48.55	1	24	1.29
ML534B1	1 <sup>1</sup> / <sub>2</sub> oz, 2 <sup>1</sup> / <sub>2</sub> " Smooth Ramekin, Bone	DOZEN	32.43	1	24	1.80
ML535B1	1 <sup>3</sup> / <sub>4</sub> oz, 2 <sup>1</sup> / <sub>2</sub> " Smooth Ramekin, Bone	DOZEN	48.03	1	48	2.35
ML536B1	2 <sup>1</sup> / <sub>2</sub> oz, 2 <sup>3</sup> / <sub>8</sub> " Smooth Ramekin, Bone	DOZEN	48.05	1	48	2.05
ML537B1	3 oz, 3 <sup>1</sup> / <sub>8</sub> " Smooth Ramekin, Bone	DOZEN	42.61	1	24	1.96
ML538B1	4 oz, 3 <sup>3</sup> / <sub>8</sub> " Smooth Ramekin, Bone	DOZEN	50.71	1	24	2.49
ML539B1	6 oz, 3 <sup>7</sup> / <sub>8</sub> " Smooth Ramekin, Bone	DOZEN	64.40	1	24	2.80

### MELAMINE RAMEKINS, WHITE

Ramekins are perfect for containing dipping sauces, small appetizers, and any small side dishes to accompany a meal.



ITEM	DESCRIPTION	U/M	WEIGHT GROSS lbs	INNER PACK	MASTER PACK	CU. FT.
ML351W1	4 <sup>1</sup> / <sub>2</sub> oz, 4 <sup>1</sup> / <sub>8</sub> " Salsa Dish White	DOZEN	23.10	1	12	1.08
ML352W1	8 oz, 4 <sup>3</sup> / <sub>4</sub> " Salsa Bowl White	DOZEN	28.97	1	12	1.43
ML507W1	1 <sup>1</sup> / <sub>2</sub> oz, 2 <sup>1</sup> / <sub>2</sub> " Fluted Ramekin, White	DOZEN	55.26	1	48	2.81
ML509W1	2 oz, 2 <sup>7</sup> / <sub>8</sub> " Fluted Ramekin, White	DOZEN	70.44	1	48	3.64
ML531W1	3 oz, 3 <sup>1</sup> / <sub>8</sub> " Fluted Ramekin, White	DOZEN	44.88	1	24	2.19
ML532W1	4 oz, 3 <sup>3</sup> / <sub>8</sub> " Fluted Ramekin, White	DOZEN	54.19	1	24	2.73
ML533W1	3 oz, 3 <sup>3</sup> / <sub>8</sub> " Fluted Ramekin White	DOZEN	48.55	1	24	1.29
ML534W1	1 <sup>1</sup> / <sub>2</sub> oz, 2 <sup>1</sup> / <sub>2</sub> " Smooth Ramekin, White	DOZEN	32.43	1	24	1.80
ML535W1	1 <sup>3</sup> / <sub>4</sub> oz, 2 <sup>1</sup> / <sub>2</sub> " Smooth Ramekin, White	DOZEN	48.03	1	48	2.35
ML536W1	2 oz, 2 <sup>7</sup> / <sub>8</sub> " Smooth Ramekin White	DOZEN	48.05	1	48	2.05
ML537W1	3 oz, 3 <sup>1</sup> / <sub>8</sub> " Smooth Ramekin, White	DOZEN	42.61	1	24	1.96
ML538W1	4 oz, 3 <sup>3</sup> / <sub>8</sub> " Smooth Ramekin, White	DOZEN	50.71	1	24	2.49
ML539W1	6 oz, 3 <sup>7</sup> / <sub>8</sub> " Smooth Ramekin, White	DOZEN	64.40	1	24	2.80





## MELAMINE RAMEKINS, CHOCOLATE

Ramekins are perfect for containing dipping sauces, small appetizers, and any small side dishes to accompany a meal.



ITEM	DESCRIPTION	U/M	WEIGHT GROSS lbs	INNER PACK	MASTER PACK	CU. FT.
ML351C1	4½ oz, 4" Salsa Dish, Chocolate	DOZEN	23.10	1	12	1.08
ML352C1	8 oz, 4¾" Salsa Dish, Chocolate	DOZEN	28.97	1	12	1.43
ML507C1	1½ oz, 2½" Fluted Ramekin, Chocolate	DOZEN	55.26	1	48	2.81
ML509C1	2 oz, 2⅞" Fluted Ramekin, Chocolate	DOZEN	70.44	1	48	3.64
ML531C1	3 oz, 3⅞" Fluted Ramekin, Chocolate	DOZEN	44.88	1	24	2.19
ML532C1	4 oz, 3⅞" Fluted Ramekin, Chocolate	DOZEN	54.19	1	24	2.73
ML533C1	3½ oz, 3⅞" Fluted Ramekin, Chocolate	DOZEN	48.55	1	24	1.29
ML534C1	1½ oz, 2½" Smooth Ramekin, Chocolate	DOZEN	32.43	1	24	1.80
ML535C1	1¾ oz, 2½" Smooth Ramekin, Chocolate	DOZEN	48.03	1	48	2.35
ML536C1	2½ oz, 2⅞" Smooth Ramekin, Chocolate	DOZEN	48.05	1	48	2.05
ML537C1	3 oz, 3⅞" Smooth Ramekin, Chocolate	DOZEN	42.61	1	24	1.96
ML538C1	4 oz, 3⅞" Smooth Ramekin, Chocolate	DOZEN	50.71	1	24	2.49
ML539C1	6 oz, 3⅞" Smooth Ramekin, Chocolate	DOZEN	64.40	1	24	2.80

## MELAMINE RAMEKINS, COBALT BLUE

Ramekins are perfect for containing dipping sauces, small appetizers, and any small side dishes to accompany a meal.



ITEM	DESCRIPTION	U/M	WEIGHT GROSS lbs	INNER PACK	MASTER PACK	CU. FT.
ML351CB1	4½ oz, 4" Salsa Dish, Cobalt Blue	DOZEN	23.10	1	12	1.08
ML352CB1	8 oz, 4¾" Salsa Dish, Cobalt Blue	DOZEN	28.97	1	12	1.43
ML507CB1	1½ oz, 2½" Fluted Ramekin, Cobalt Blue	DOZEN	55.26	1	48	2.81
ML509CB1	2 oz, 2⅞" Fluted Ramekin, Cobalt Blue	DOZEN	70.44	1	48	3.64
ML531CB1	3 oz, 3⅞" Fluted Ramekin, Cobalt Blue	DOZEN	44.88	1	24	2.19
ML532CB1	4 oz, 3⅞" Fluted Ramekin, Cobalt Blue	DOZEN	54.19	1	24	2.73
ML533CB1	3½ oz, 3⅞" Fluted Ramekin, Cobalt Blue	DOZEN	48.55	1	24	1.29
ML534CB1	1½ oz, 2½" Smooth Ramekin, Cobalt Blue	DOZEN	32.43	1	24	1.80
ML535CB1	1¾ oz, 2½" Smooth Ramekin, Cobalt Blue	DOZEN	48.03	1	48	2.35
ML536CB1	2½ oz, 2⅞" Smooth Ramekin, Cobalt Blue	DOZEN	48.05	1	48	2.05
ML537CB1	3 oz, 3⅞" Smooth Ramekin, Cobalt Blue	DOZEN	42.61	1	24	1.96
ML538CB1	4 oz, 3⅞" Smooth Ramekin, Cobalt Blue	DOZEN	50.71	1	24	2.49
ML539CB1	6 oz, 3⅞" Smooth Ramekin, Cobalt Blue	DOZEN	64.40	1	24	2.80

## MELAMINE RAMEKINS, BLACK

Ramekins are perfect for containing dipping sauces, small appetizers, and any small side dishes to accompany a meal.



ITEM	DESCRIPTION	U/M	WEIGHT GROSS lbs	INNER PACK	MASTER PACK	CU. FT.
ML351BL1	4½ oz, 4" Salsa Dish, Black	DOZEN	23.10	1	12	1.08
ML352BL1	8 oz, 4¾" Salsa Dish, Black	DOZEN	28.97	1	12	1.43
ML507BL1	1½ oz, 2½" Fluted Ramekin, Black	DOZEN	55.26	1	48	2.81
ML509BL1	2 oz, 2⅞" Fluted Ramekin, Black	DOZEN	70.44	1	48	3.64
ML531BL1	3 oz, 3⅝" Fluted Ramekin, Black	DOZEN	44.88	1	24	2.19
ML532BL1	4 oz, 3⅞" Fluted Ramekin, Black	DOZEN	54.19	1	24	2.73
ML533BL1	3½ oz, 3⅞" Fluted Ramekin, Black	DOZEN	48.55	1	24	1.29
ML534BL1	1½ oz, 2½" Smooth Ramekin, Black	DOZEN	32.43	1	24	1.80
ML535BL1	1¾ oz, 2½" Smooth Ramekin, Black	DOZEN	48.03	1	48	2.35
ML536BL1	2½ oz, 2⅞" Smooth Ramekin, Black	DOZEN	48.05	1	48	2.05
ML537BL1	3 oz, 3⅝" Smooth Ramekin, Black	DOZEN	42.61	1	24	1.96
ML538BL1	4 oz, ¾" Smooth Ramekin, Black	DOZEN	50.71	1	24	2.49
ML539BL1	6 oz, 3⅞" Smooth Ramekin, Black	DOZEN	64.40	1	24	2.80

## PLASTIC RAMEKINS, BLACK

Ramekins are perfect for containing dipping sauces, small appetizers, and any small side dishes to accompany a meal.



ITEM	DESCRIPTION	U/M	WEIGHT GROSS lbs	INNER PACK	MASTER PACK	CU. FT.
PL351BL1	4½ oz, 4" Salsa Dish, Black	DOZEN	20.61	1	12	1.11
PL352BL1	8 oz, 4¾" Salsa Dish, Black	DOZEN	26.54	1	12	1.68
PL507BL1	1½ oz, 2½" Fluted Ramekin, Black	DOZEN	47.50	1	48	3.20
PL509BL1	2 oz, 2⅞" Fluted Ramekin, Black	DOZEN	53.23	1	48	2.68
PL531BL1	3 oz, 3⅝" Fluted Ramekin, Black	DOZEN	37.57	1	24	1.83
PL532BL1	4 oz, 3⅞" Fluted Ramekin, Black	DOZEN	43.36	1	24	1.68
PL533BL1	3½ oz, 3⅞" Fluted Ramekin, Black	DOZEN	39.48	1	24	2.14
PL534BL1	1½ oz, 2½" Smooth Ramekin, Black	DOZEN	31.94	1	24	1.94
PL535BL1	1¾ oz, 2½" Smooth Ramekin, Black	DOZEN	45.22	1	48	2.88
PL536BL1	2½ oz, 2⅞" Smooth Ramekin, Black	DOZEN	47.32	1	48	2.35
PL537BL1	3 oz, 3⅝" Smooth Ramekin, Black	DOZEN	35.61	1	24	1.83
PL538BL1	4 oz, ¾" Smooth Ramekin, Black	DOZEN	45.74	1	24	2.13
PL539BL1	6 oz, 3⅞" Smooth Ramekin, Black	DOZEN	46.39	1	24	2.10

## MELAMINE RAMEKIN RETAIL PACKS, BONE

Ramekins are perfect for containing dipping sauces, small appetizers, and any small side dishes to accompany a meal.



ITEM	DESCRIPTION	U/M	WEIGHT GROSS lbs	INNER PACK	MASTER PACK	CU. FT.
ML507B1R	1 1/2 oz, 2 1/2" Fluted Ramekin, Bone-Retail Pack	PACK OF 12	17.66	1	12	0.95
ML509B1R	2 oz, 2 7/8" Fluted Ramekin, Bone-Retail Pack	PACK OF 12	21.16	1	12	1.26
ML531B1R	3 oz, 3/8" Fluted Ramekin, Bone-Retail Pack	PACK OF 12	25.92	1	12	1.57
ML532B1R	4 oz, 3 3/8" Fluted Ramekin, Bone-Retail Pack	PACK OF 12	29.41	1	12	2.00
ML535B1R	1 3/4 oz, 2 1/2" Smooth Ramekin, Bone-Retail Pack	PACK OF 12	16.08	1	12	1.00
ML536B1R	2 1/2 oz, 2 7/8" Smooth Ramekin, Bone-Retail Pack	PACK OF 12	18.30	1	12	1.17
ML537B1R	3 oz, 3 1/8" Smooth Ramekin, Bone-Retail Pack	PACK OF 12	24.65	1	12	1.62
ML538B1R	4 oz, 3 3/8" Smooth Ramekin, Bone-Retail Pack	PACK OF 12	27.82	1	12	1.95



## MELAMINE RAMEKIN RETAIL PACKS, WHITE

Ramekins are perfect for containing dipping sauces, small appetizers, and any small side dishes to accompany a meal.



ITEM	DESCRIPTION	U/M	WEIGHT GROSS lbs	INNER PACK	MASTER PACK	CU. FT.
ML507W1R	1 1/2 oz, 2 1/2" Fluted Ramekin, White-Retail Pack	PACK OF 12	17.66	1	12	0.95
ML509W1R	2 oz, 2 7/8" Fluted Ramekin, White-Retail Pack	PACK OF 12	21.16	1	12	1.26
ML531W1R	3 oz, 3 1/8" Fluted Ramekin, White-Retail Pack	PACK OF 12	25.92	1	12	1.57
ML532W1R	4 oz, 3 3/8" Fluted Ramekin, White-Retail Pack	PACK OF 12	29.41	1	12	2.00
ML535W1R	1 3/4 oz, 2 1/2" Smooth Ramekin, White-Retail Pack	PACK OF 12	16.08	1	12	1.00
ML536W1R	2 1/2 oz, 2 7/8" Smooth Ramekin, White-Retail Pack	PACK OF 12	18.30	1	12	1.17
ML537W1R	3 oz, 3 1/8" Smooth Ramekin, White-Retail Pack	PACK OF 12	24.65	1	12	1.62
ML538W1R	4 oz, 3 3/8" Smooth Ramekin, White-Retail Pack	PACK OF 12	27.82	1	12	1.95



# Serving Utensil

Available in slotted, and solid style, these utensils provide a touch of color and accents to food service.

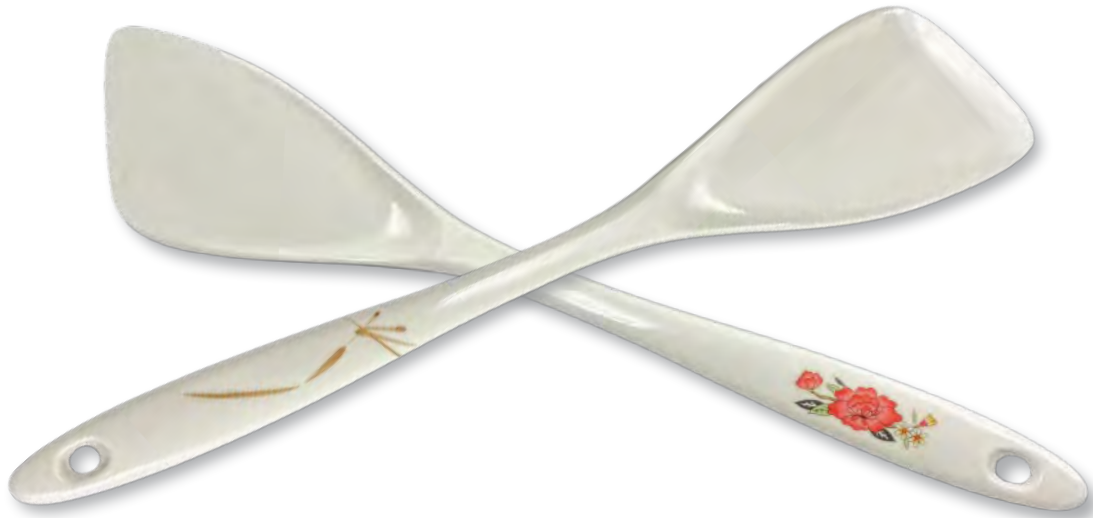

MELAMINE

## Thailand



7001TL



7005TL



7006TL



7007TL



7008TL



7009TL

Item	Description	U/M	Weight Gross lbs	Inner Pack	Master Pack	Cu. Ft.
7001TL	1 oz, 7 <sup>3</sup> / <sub>8</sub> " x 2 <sup>1</sup> / <sub>2</sub> ", Soup Ladle	Dozen	33.07	5	40	2.08
7005TL	1 <sup>1</sup> / <sub>2</sub> oz, 8 <sup>1</sup> / <sub>4</sub> " x 2 <sup>3</sup> / <sub>4</sub> ", Rice Ladle	Dozen	48.50	2	30	2.38
7006TL	2 <sup>1</sup> / <sub>2</sub> oz, 10 <sup>1</sup> / <sub>4</sub> " x 3 <sup>3</sup> / <sub>8</sub> ", Soup Ladle	Dozen	41.89	2	30	3.85
7007TL	2 <sup>1</sup> / <sub>2</sub> oz, 8 <sup>7</sup> / <sub>8</sub> " x 2 <sup>3</sup> / <sub>4</sub> ", Ladle/Spoon	Dozen	44.78	2	30	2.55
7008TL	1 <sup>1</sup> / <sub>2</sub> oz, 9 <sup>1</sup> / <sub>4</sub> " x 3", Rice Ladle	Dozen	41.89	2	30	2.55
7009TL	12 <sup>1</sup> / <sub>2</sub> " x 2 <sup>1</sup> / <sub>2</sub> ", Spatula/Turner	Dozen	41.89	2	30	2.49

**\*\* Rice Ladle, Soup Spoon, Spatula and Turner shown on this page are not NSF Certified\*\***



White



W7106



W7104



W7102



W7105



W7103



W7101



W7009

Item	Description	U/M	Weight Gross lbs	Inner Pack	Master Pack	Cu. Ft.
W7009	12" x 2½", Slide Turner	Dozen	40.96	2	30	2.49
W7101	12" x 2¾", Solid Turner	Dozen	40.96	2	30	4.35
W7102	12" x 2½", Solid Spoon	Dozen	41.76	2	30	2.83
W7103	12" x 2⅝", Slotted Spoon	Dozen	47.30	2	30	2.81
W7104	12" x 1⅞", Pasta Fork	Dozen	50.64	2	30	4.76
W7105	12" x 1¾", Salad Turner	Dozen	42.68	2	30	2.33
W7106	12" x 3½", Ladle	Dozen	61.00	2	30	4.78

Bamboo



7001BO



7005BO



7006BO



7007BO



7008BO



7009BO

Item	Description	U/M	Weight Gross lbs	Inner Pack	Master Pack	Cu. Ft.
7001BO	1 oz, 7⅞" x 2½", Soup Ladle	Dozen	33.07	5	40	2.08
7005BO	1½ oz, 8¼" x 2¾", Rice Ladle	Dozen	48.50	2	30	2.38
7006BO	2½ oz, 10¼" x 3 ⅜", Soup Ladle	Dozen	41.89	2	30	3.85
7007BO	2½ oz, 8⅞" x 2¾", Ladle/Spoon	Dozen	44.78	2	30	2.55
7008BO	1½ oz, 9¼" x 3", Rice Ladle	Dozen	41.89	2	30	2.55
7009BO	12½" x 2½", Spatula/Turner	Dozen	41.89	2	30	2.49

**\*\* Rice Ladle, Soup Spoon, Spatula and Turner shown on this page are not NSF Certified\*\***

# Gastronorm Pans



40mm • 65mm • 100mm



Stackable for storage



PMS, E., H., F., G., I., J., K., L., M., N., O., P., Q., R., S., T., U., V., W., X., Y., Z., AA, AB, AC, AD, AE, AF, AG, AH, AI, AJ, AK, AL, AM, AN, AO, AP, AQ, AR, AS, AT, AU, AV, AW, AX, AY, AZ, BA, BB, BC, BD, BE, BF, BG, BH, BI, BJ, BK, BL, BM, BN, BO, BP, BQ, BR, BS, BT, BU, BV, BW, BX, BY, BZ, CA, CB, CC, CD, CE, CF, CG, CH, CI, CJ, CK, CL, CM, CN, CO, CP, CQ, CR, CS, CT, CU, CV, CW, CX, CY, CZ, DA, DB, DC, DD, DE, DF, DG, DH, DI, DJ, DK, DL, DM, DN, DO, DP, DQ, DR, DS, DT, DU, DV, DW, DX, DY, DZ, EA, EB, EC, ED, EE, EF, EG, EH, EI, EJ, EK, EL, EM, EN, EO, EP, EQ, ER, ES, ET, EU, EV, EW, EX, EY, EZ, FA, FB, FC, FD, FE, FF, FG, FH, FI, FJ, FK, FL, FM, FN, FO, FP, FQ, FR, FS, FT, FU, FV, FW, FX, FY, FZ, GA, GB, GC, GD, GE, GF, GG, GH, GI, GJ, GK, GL, GM, GN, GO, GP, GQ, GR, GS, GT, GU, GV, GW, GX, GY, GZ, HA, HB, HC, HD, HE, HF, HG, HH, HI, HJ, HK, HL, HM, HN, HO, HP, HQ, HR, HS, HT, HU, HV, HW, HX, HY, HZ, IA, IB, IC, ID, IE, IF, IG, IH, II, IJ, IK, IL, IM, IN, IO, IP, IQ, IR, IS, IT, IU, IV, IW, IX, IY, IZ, JA, JB, JC, JD, JE, JF, JG, JH, JI, JJ, JK, JL, JM, JN, JO, JP, JQ, JR, JS, JT, JU, JV, JW, JX, JY, JZ, KA, KB, KC, KD, KE, KF, KG, KH, KI, KJ, KK, KL, KM, KN, KO, KP, KQ, KR, KS, KT, KU, KV, KW, KX, KY, KZ, LA, LB, LC, LD, LE, LF, LG, LH, LI, LJ, LK, LL, LM, LN, LO, LP, LQ, LR, LS, LT, LU, LV, LW, LX, LY, LZ, MA, MB, MC, MD, ME, MF, MG, MH, MI, MJ, MK, ML, MM, MN, MO, MP, MQ, MR, MS, MT, MU, MV, MW, MX, MY, MZ, NA, NB, NC, ND, NE, NF, NG, NH, NI, NJ, NK, NL, NM, NN, NO, NP, NQ, NR, NS, NT, NU, NV, NW, NX, NY, NZ, OA, OB, OC, OD, OE, OF, OG, OH, OI, OJ, OK, OL, OM, ON, OO, OP, OQ, OR, OS, OT, OU, OV, OW, OX, OY, OZ, PA, PB, PC, PD, PE, PF, PG, PH, PI, PJ, PK, PL, PM, PN, PO, PP, PQ, PR, PS, PT, PU, PV, PW, PX, PY, PZ, QA, QB, QC, QD, QE, QF, QG, QH, QI, QJ, QK, QL, QM, QN, QO, QP, QQ, QR, QS, QT, QU, QV, QW, QX, QY, QZ, RA, RB, RC, RD, RE, RF, RG, RH, RI, RJ, RK, RL, RM, RN, RO, RP, RQ, RR, RS, RT, RU, RV, RW, RX, RY, RZ, SA, SB, SC, SD, SE, SF, SG, SH, SI, SJ, SK, SL, SM, SN, SO, SP, SQ, SR, SS, ST, SU, SV, SW, SX, SY, SZ, TA, TB, TC, TD, TE, TF, TG, TH, TI, TJ, TK, TL, TM, TN, TO, TP, TQ, TR, TS, TT, TU, TV, TW, TX, TY, TZ, UA, UB, UC, UD, UE, UF, UG, UH, UI, UJ, UK, UL, UM, UN, UO, UP, UQ, UR, US, UT, UY, UZ, VA, VB, VC, VD, VE, VF, VG, VH, VI, VJ, VK, VL, VM, VN, VO, VP, VQ, VR, VS, VT, VU, VV, VW, VX, VY, VZ, WA, WB, WC, WD, WE, WF, WG, WH, WI, WJ, WK, WL, WM, WN, WO, WP, WQ, WR, WS, WT, WU, WV, WW, WX, WY, WZ, XA, XB, XC, XD, XE, XF, XG, XH, XI, XJ, XK, XL, XM, XN, XO, XP, XQ, XR, XS, XT, XU, XV, XW, XX, XY, XZ, YA, YB, YC, YD, YE, YF, YG, YH, YI, YJ, YK, YL, YM, YN, YO, YP, YQ, YR, YS, YT, YU, YV, YW, YX, YY, YZ, ZA, ZB, ZC, ZD, ZE, ZF, ZG, ZH, ZI, ZJ, ZK, ZL, ZM, ZN, ZO, ZP, ZQ, ZR, ZS, ZT, ZU, ZV, ZW, ZX, ZY, ZZ



1 1/2" Height / 40mm



2 1/2" Height / 65mm



4" Height / 100mm

Item	Description	U/M	Weight Gross lbs	Inner Pack	Master Pack	Cu. Ft.
GN1001W	1/1, 40mm, 20 3/4" x 12 3/4" x 1 1/2"	Each	51.50	4	12	2.12
GN1002W	1/1, 65mm, 20 3/4" x 12 3/4" x 2 1/2"	Each	42.20	2	8	2.94
GN1004W	1/1, 100mm, 20 3/4" x 12 3/4" x 4"	Each	47.11	2	8	3.82
GN1121W	1/2, 40mm, 12 3/4" x 10 3/8" x 1 1/2"	Each	44.88	6	24	1.89
GN1122W	1/2, 65mm, 12 3/4" x 10 3/8" x 2 1/2"	Each	36.99	4	16	2.16
GN1124W	1/2, 100mm, 12 3/4" x 10 3/8" x 4"	Each	42.79	4	16	2.72
GN1132W	1/3, 65mm, 12 3/4" x 6 7/8" x 2 1/2"	Each	42.57	6	24	1.88
GN1134W	1/3, 100mm, 12 3/4" x 7" x 4"	Each	46.65	6	24	2.33
GN1142W	1/4, 65mm, 10 1/2" x 6 3/8" x 2 1/2"	Each	42.13	6	24	1.66
GN1144W	1/4, 100mm, 10 1/2" x 6 1/4" x 4"	Each	39.88	6	24	1.77
GN1162W	1/6, 65mm, 7" x 6 3/8" x 2 1/2"	Each	41.89	12	36	1.50
GN1164W	1/6, 100mm, 7" x 6 3/8" x 4"	Each	41.03	12	36	1.65
GN1221W	2/4, 40mm, 20 3/4" x 6 3/8" x 1 1/2"	Each	48.55	6	24	1.89
GN1222W	2/4, 65mm, 20 3/4" x 6 3/8" x 2 1/2"	Each	43.17	4	16	2.28
GN1232W	2/3, 65mm, 14" x 12 7/8" x 2 1/2"	Each	30.27	2	8	1.96



# ASIAN COOKWARE

ASIAN COOKWARE



BANP001

BANP002

## WOOD ROLLING PIN (ASIAN STYLE)

Use to roll out various types of dough when making food items.

ITEM	DESCRIPTION	U/M	WEIGHT GROSS lbs	INNER PACK	MASTER PACK	CU. FT.
BANP001	12", 1" Diameter	EACH	31.97	1	120	0.88
BANP002	14", 1" Diameter	EACH	34.17	1	120	1.02



WDSP012  
WDSP014  
WDSP016  
WDSP018

## WOODEN SPOON

Use for stirring sauce, soups, and other cooking needs.

ITEM	DESCRIPTION	U/M	WEIGHT GROSS lbs	INNER PACK	MASTER PACK	CU. FT.
WDSP012	12"	EACH	7.50	12	72	0.42
WDSP014	14"	EACH	8.20	12	72	0.49
WDSP016	16"	EACH	8.82	12	72	0.57
WDSP018	18"	EACH	9.70	12	72	0.62



SLLD309  
SLLD310  
SLLD311

SLSPA001  
SLSPA002

## SHOVEL & LADLE WITH WOOD HANDLE

Stainless steel ladle and shovel both come with hardwood handle. Arm extends up to 19 3/4" for deep pots and safety.

ITEM	DESCRIPTION	U/M	WEIGHT GROSS lbs	INNER PACK	MASTER PACK	CU. FT.
SLLD309	6 oz, 4" x 4 1/4" x 16 3/4"	EACH	41.80	25	100	1.79
SLLD310	8 oz, 4 1/4" x 4 1/2" x 18"	EACH	52.91	25	100	2.05
SLLD311	10 oz, 4 1/2" x 5" x 19 3/4"	EACH	63.93	25	100	2.28
SLSPA001	4 1/2" x 4 1/2" x 19 1/2"	EACH	48.50	25	100	2.09
SLSPA002	4" x 4 1/4" x 17 3/4"	EACH	44.09	25	100	1.87



MRGR001  
MRGR002  
MRGR003

## MARBLE GRINDER

Bowl style marble grinder. Ideal for blending spices and herbs.

Made in Taiwan

ITEM	DESCRIPTION	U/M	WEIGHT GROSS lbs	INNER PACK	MASTER PACK	CU. FT.
MRGR003	3" Diameter x 2 1/8" Height	EACH	39.68	24	24	1.33
MRGR001	4" Diameter x 2 3/8" Height	EACH	39.68	12	12	1.09
MRGR002	5" Diameter x 4 1/2" Height	EACH	41.89	8	8	1.23



## ALUMINUM BASIN

With tapered edges.



ITEM	DESCRIPTION	U/M	WEIGHT GROSS lbs	INNER PACK	MASTER PACK	CU. FT.
ALBS001	19" x 6"	EACH	17.64	1	10	2.34
ALBS002	20" x 6"	EACH	24.25	1	10	2.58
ALBS003	21½" x 6½"	EACH	25.35	1	10	2.99
ALBS004	23" x 7"	EACH	28.66	1	10	3.68
ALBS005	25" x 7"	EACH	33.07	1	10	5.00
ALBS006	27" x 7½"	EACH	44.09	1	10	6.05
ALBS007	30" x 7½"	EACH	57.32	1	10	7.35



ALBS001

## ASIAN STYLE ALUMINUM COLANDER

With tapered edges.



ITEM	DESCRIPTION	U/M	WEIGHT GROSS lbs	INNER PACK	MASTER PACK	CU. FT.
ALSB001	19½" x 6"	EACH	29.76	1	20	3.35
ALSB002	17½" x 5"	EACH	28.66	1	20	2.76
ALSB003	15¾" x 1½"	EACH	20.28	1	20	2.02
ALSB004	15" x 4"	EACH	19.84	1	20	1.72
ALSB005	13¼" x 4"	EACH	26.46	1	20	1.24
ALSB006	12" x 3¼"	EACH	28.66	1	20	0.79
ALSB007	11" x 3"	EACH	17.64	1	20	0.79
ALSB008	10" x 3"	EACH	26.46	1	20	0.62
ALSB009	8½" x 2¾"	EACH	19.84	1	20	0.49



ALSB009



ALSB001

## BAMBOO SKEWER

Thin, smooth-pointed bamboo skewers. Use for barbecues, or simply for holding ingredients together while cooking. 100 pcs/bag

ITEM	DESCRIPTION	U/M	WEIGHT GROSS lbs	INNER PACK	MASTER PACK	CU. FT.
BAST006	6"	BAG	17.64	30	120	0.57
BAST008	8"	BAG	23.15	30	120	0.74
BAST010	10"	BAG	35.27	30	120	1.30
BAST012	12"	BAG	48.50	30	120	1.54



BAST010



## BAMBOO HANDLE SKIMMER (COARSE MESH)

Round framed stainless steel mesh wires with riveted bamboo handle. Elongated handle is excellent for added safety precaution while deep frying or skimming. Concave net captures food while straining oil and other liquids.



ITEM	DESCRIPTION	U/M	WEIGHT GROSS lbs	INNER PACK	MASTER PACK	CU. FT.
SLSKR004	4" x 13½"	EACH	28.66	1	200	2.53
SLSKR006	6" x 16"	EACH	50.71	1	200	5.04
SLSKR008	8" x 19"	EACH	26.06	1	50	2.88
SLSKR010	10" x 21"	EACH	20.04	1	30	2.97
SLSKR012	12" x 26"	EACH	30.07	1	30	4.94
SLSKR014	14" x 28"	EACH	40.08	1	30	6.31



SLSKR004 ~ SLSKR014



SLNS001

SLNS002



SLNS005

SLNS536

SLNS553

### NOODLE SKIMMER

Sturdy stainless steel wiring with outer framework and wood handle. Deep pockets catch noodles securely while straining water, oil or other liquids. Convenient storage with built in hook hanger.



ITEM	DESCRIPTION	U/M	WEIGHT GROSS lbs	INNER PACK	MASTER PACK	CU. FT.
SLNS001	5½" x 5½" x 13¾" Flat Wood Handle	EACH	33.07	12	72	3.92
SLNS002	5½" x 5½" x 13¾" Round Wood Handle	EACH	31.11	12	72	3.92
SLNS005	5½" x 4¼" Bamboo Handle	EACH	26.40	1	50	2.99
SLNS536	5½" x 6" Flat Bottom, Round, S/S w/ Wood Handle	EACH	26.01	1	36	4.68
SLNS553	5" x 5¼" Flat Bottom, Round, S/S with Wood Handle	EACH	19.67	1	36	3.67

### SKIMMER FOR SHABU SHABU

Ideal for scooping small food items in Shabu-shabu and Chinese hot pots.



HPCS008

ITEM	DESCRIPTION	U/M	WEIGHT GROSS lbs	INNER PACK	MASTER PACK	CU. FT.
HPCS008	2½" Diameter x 8¾" Length	EACH	31.53	200	1000	2.65

### BAMBOO HANDLE SKIMMER



SLSKR004GV ~  
SLSKR014GV



SLSKR104GV ~ SLSKR612GV

ITEM	DESCRIPTION	U/M	WEIGHT GROSS lbs	INNER PACK	MASTER PACK	CU. FT.
<b>Coarse Mesh</b>						
SLSKR004GV	4"	EACH	34.11	1	200	2.69
SLSKR006GV	6"	EACH	44.09	1	200	5.42
SLSKR008GV	8"	EACH	31.00	1	50	2.88
SLSKR010GV	10"	EACH	22.05	1	30	3.19
SLSKR012GV	12"	EACH	34.61	1	30	4.94
SLSKR014GV	14"	EACH	47.40	1	30	6.31
<b>Fine Mesh</b>						
SLSKR104GV	4"	EACH	32.87	1	200	2.69
SLSKR106GV	6"	EACH	72.75	1	200	5.42
SLSKR108GV	8"	EACH	34.17	1	50	2.88
SLSKR110GV	10"	EACH	26.00	1	30	3.19
SLSKR112GV	12"	EACH	41.01	1	30	4.94
SLSKR114GV	14"	EACH	53.99	1	30	6.31
<b>Bowl</b>						
SLSKR512GV	5" x 2½"	EACH	17.64	1	50	1.72
<b>Flat</b>						
SLSKR612GV	6" x 1½"	EACH	17.59	1	50	1.87

**CARVING KNIFE**

Stainless steel blades with riveted wooden handle.

Made in Taiwan

ITEM	DESCRIPTION	U/M	WEIGHT GROSS lbs	INNER PACK	MASTER PACK	CU. FT.
JAS013090	3½" Carving Knife	EACH	26.46	12	120	2.40
SLCN001	Carving Knife/Set of 6	SET	30.42	1	120	2.00



JAS013090



SLCN001

**JAPANESE KNIFE**

Stainless steel blades, with riveted wooden handle.

Made in Taiwan

ITEM	DESCRIPTION (BLADE SIZE)	U/M	WEIGHT GROSS lbs	INNER PACK	MASTER PACK	CU. FT.
JAS013001	7.5" x 1.65"	EACH	26.46	6	60	2.00
JAS013002	6.5" x 1.9"	EACH	26.46	6	60	2.00
JAS013003	11.5" x 1.9"	EACH	28.66	6	60	2.03



JAS013001



JAS013002



JAS013003

**JAPANESE SASHIMI KNIFE**

Stainless steel blades, with riveted wooden handle. Finely slices sashimi into the required texture. Makes a great tool for sushi bars.

Made in Taiwan

ITEM	DESCRIPTION (BLADE SIZE)	U/M	WEIGHT GROSS lbs	INNER PACK	MASTER PACK	CU. FT.
JAS014210	8½" x 1½"	EACH	39.68	6	60	2.20
JAS014240	9½" x 1½"	EACH	39.68	6	60	2.50
JAS014270	10¾" x 1½"	EACH	44.09	6	60	2.50
JAS014300	12" x 1½"	EACH	48.50	6	60	2.50



JAS014210



JAS014240



JAS014270



JAS014300

**JAPANESE COW KNIFE**

Durable stainless steel knives with riveted ABS handles. Withstands any wear and tear from cutting through beef. Chops and cuts meat with precision.

Made in Taiwan

ITEM	DESCRIPTION (BLADE SIZE)	U/M	WEIGHT GROSS lbs	INNER PACK	MASTER PACK	CU. FT.
JAS012180	7½" x 1¼"	EACH	44.09	6	60	2.33
JAS012210	8¾" x 1¼"	EACH	46.30	6	60	2.33
JAS012240	9½" x 1¼"	EACH	48.50	6	60	2.33
JAS012270	10½" x 2"	EACH	55.12	6	60	2.33
JAS012300	11¾" x 2½"	EACH	57.32	6	60	2.33
JAS012330	13" x 2¼"	EACH	60.63	6	60	2.60



JAS012180



JAS012210



JAS012240



JAS012270



JAS012300



JAS012330



SLKF002

**SHARP KNIFE**

Stainless steel knife with a sharp angled tip. Balanced wooden handle.

Made in Taiwan

ITEM	DESCRIPTION (BLADE SIZE)	U/M	WEIGHT GROSS lbs	INNER PACK	MASTER PACK	CU. FT.
SLKF002	7.2" x 2.9"	EACH	44.09	1	50	2.49



SLKF021

**KING KNIFE**

Sharp stainless steel king knife for chopping, slicing and dicing. With wooden handle. Blade size in 7". Also available in Kimli (retailed boxed).

Made in Taiwan

ITEM	DESCRIPTION (BLADE SIZE)	U/M	WEIGHT GROSS lbs	INNER PACK	MASTER PACK	CU. FT.
SLKF021	7" x 3½"	EACH	44.09	1	50	2.40



SLKF003HK

SLKF004HK

SLKF005HK

**PING KNIFE**

Provides professional results with reliable cast iron blade. Made to last through heavy duty professional use. Comes with a wooden handle.

Made in Taiwan

ITEM	DESCRIPTION (BLADE SIZE)	U/M	WEIGHT GROSS lbs	INNER PACK	MASTER PACK	CU. FT.
SLKF003HK	9¼" x 4½"	EACH	46.72	1	50	2.50
SLKF004HK	8½" x 4¼"	EACH	40.94	1	50	2.50
SLKF005HK	7¾" x 4"	EACH	38.58	1	50	2.50



JAS010055A

JAS010055B

**SHARP AND ANGLE KNIFE**

For the proper preparation of vegetables and meats. Sharp stainless steel blade riveted onto wooden handle. Blade size available in 6¾" and 7". Sharp or angled.

Made in Taiwan

ITEM	DESCRIPTION (BLADE SIZE)	U/M	WEIGHT GROSS lbs	INNER PACK	MASTER PACK	CU. FT.
JAS010055A	11" x 3"	EACH	59.52	6	60	2.46
JAS010055B	11" x 3½"	EACH	59.52	6	60	2.46

### PING & WAN WOO KNIFE (SQUARE HEAD)

Cast iron square head knife with wooden handle. A great addition to any knife collection.

Made in Taiwan

ITEM	DESCRIPTION (BLADE SIZE)	U/M	WEIGHT GROSS lbs	INNER PACK	MASTER PACK	CU. FT.
SLKF012	9½" x 4½" Wan Woo Knife	EACH	72.35	1	50	1.26
SLKF018	8¼" x 4¼" Ping Knife	EACH	39.01	1	50	1.65

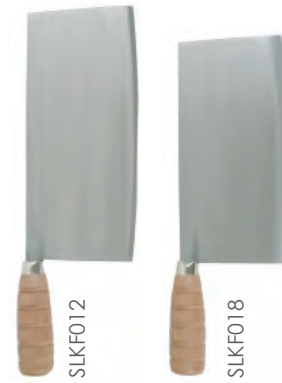

### PING & WAN WOO KNIFE (ROUND HEAD)

Cast iron round head knife with wooden handle. A great addition to any knife collection.

Made in Taiwan

ITEM	DESCRIPTION (BLADE SIZE)	U/M	WEIGHT GROSS lbs	INNER PACK	MASTER PACK	CU. FT.
SLKF019	9" x 4½" Wan Woo Knife	EACH	60.22	1	50	1.68
SLKF025	9" x 4¼" Shanghai Ping Knife	EACH	38.90	1	50	1.65



### CHINESE CLEAVER

For slicing through bones and other tough textures. Features a cast iron square-headed blade and wooden handle. Essential for meat and poultry preparation.

Made in Taiwan

ITEM	DESCRIPTION (BLADE SIZE)	U/M	WEIGHT GROSS lbs	INNER PACK	MASTER PACK	CU. FT.
SLKF016	8½" x 4½" Bone Knife	EACH	100.59	1	50	1.64
SLKF017	7½" x 4" Meat Knife	EACH	72.12	1	50	1.68
SLKF020	8" x 2" Duck Knife	EACH	20.19	1	50	1.48



### ASIAN CLEAVER

Sharp and precise for chopping through tough meat and bones. Stainless steel blade with riveted wooden handle.

ITEM	DESCRIPTION (BLADE SIZE)	U/M	WEIGHT GROSS lbs	INNER PACK	MASTER PACK	CU. FT.
OW189	6" x 2¾"	EACH	22.05	6	48	0.43





ALSR001

**WOK RACK**

Steel wok rack, with open top and perforated sides on flat steady rim. Offers support by holding heavy woks in place on the table or counter. Helps to keep the kitchen safe.

Made in Taiwan

ITEM	DESCRIPTION	U/M	WEIGHT GROSS lbs	INNER PACK	MASTER PACK	CU. FT.
ALSR001	Top: 8 1/4" Diameter, Bottom: 10" Diameter	EACH	28.66	1	100	1.17



ALPC001, ALPC002

**WOK COVER**

Keeps oil splatters, heat, or any other contents contained in the wok.



ALUMINUM

Made in Taiwan

ITEM	DESCRIPTION	U/M	WEIGHT GROSS lbs	INNER PACK	MASTER PACK	CU. FT.
ALPC001	12 1/4" Diameter	EACH	13.00	1	60	1.10
ALPC002	13 1/4" Diameter	EACH	15.15	1	60	2.10

SLWK008C



SLWK008

**STAINLESS STEEL WOK & COVER**

Stainless steel wok with handle.



STAINLESS STEEL

ITEM	DESCRIPTION	U/M	WEIGHT GROSS lbs	INNER PACK	MASTER PACK	CU. FT.
SLWK008C	Cover 7 3/4"	EACH	31.90	1	60	0.23
SLWK008	Wok 8"	EACH	41.89	1	60	0.60

**CURVED RIM WOK**

Prevents drips with curved rim. Heavy iron wok with rounded handles.

Made in Taiwan



IRWC001 ~ IRWC005

ITEM	DESCRIPTION	U/M	WEIGHT GROSS lbs	INNER PACK	MASTER PACK	CU. FT.
IRWC001	19"	EACH	4.19	1	1	0.27
IRWC002	21 1/2"	EACH	6.28	1	1	0.40
IRWC003	24"	EACH	6.83	1	1	0.64
IRWC004	26"	EACH	8.38	1	1	0.77
IRWC005	28 3/4"	EACH	9.70	1	1	1.44

### NON-STICK WOOD HANDLE WOK

A functional non-stick wok. Heavy carbon steel wok with wooden handles. Good leverage.

Made in Taiwan

ITEM	DESCRIPTION	U/M	WEIGHT GROSS lbs	INNER PACK	MASTER PACK	CU. FT.
TF001	12"	EACH	30.86	1	12	1.00
TF002	14" w/Helper Handle	EACH	39.68	1	12	1.70



TF002

### JAPANESE JIN-PING WOK (ONE PIECE STEEL)

Japanese Jin-Ping Woks. Extra strength steel with reinforced sandwiched welding.

ITEM	DESCRIPTION	U/M	WEIGHT GROSS lbs	INNER PACK	MASTER PACK	CU. FT.
IRJWC001	14"	EACH	38.80	1	12	1.56
IRJWC002	16"	EACH	46.30	1	12	2.01
IRJWC301	14"	EACH	33.51	1	10	1.77
IRJWC302	16"	EACH	38.80	1	10	2.12

Made in Taiwan

Made in Taiwan

Made in Japan

Made in Japan



IRJWC001, IRJWC002



Sandwich Weld



IRJWC301, IRJWC302

### TAIWAN WOK

Heavy-duty iron wok. A valuable tool for cooking.

Made in Taiwan

ITEM	DESCRIPTION	U/M	WEIGHT GROSS lbs	INNER PACK	MASTER PACK	CU. FT.
IRWK001	14"	EACH	39.68	1	12	1.88
IRWK002	16"	EACH	46.30	1	12	2.45



IRWK001, IRWK002

### WOOD HANDLE WOK

Iron wok for professional use. Made to last through excessive use. Comes with a wooden handle.

Made in Taiwan

ITEM	DESCRIPTION	U/M	WEIGHT GROSS lbs	INNER PACK	MASTER PACK	CU. FT.
IRWC006	14"	EACH	2.76	1	1	1.03
IRWC007	16"	EACH	3.20	1	1	0.28



IRWC006, IRWC007



ALSP002, ALSP003, ALSP004

**SNOW FLAT PAN**

Studded with round imprints. Wooden handle with a built-in hanging loop.



ITEM	DESCRIPTION	U/M	WEIGHT GROSS lbs	INNER PACK	MASTER PACK	CU. FT.
ALSP002	7 1/4" x 2 3/4"	EACH	33.07	20	120	8.30
ALSP003	8" x 3"	EACH	37.50	20	120	9.30
ALSP004	9" x 3"	EACH	28.66	20	80	8.90



SLSTP714

**ONE HANDLE POT WITH LID**

Mirror polished stainless steel pot with lid. A great tool for preparing authentic cuisines.



ITEM	DESCRIPTION	U/M	WEIGHT GROSS lbs	INNER PACK	MASTER PACK	CU. FT.
SLSTP714	7 1/4" Diameter One Handle Pot	EACH	15.43	1	12	1.83



CETW001

**SAN BAI WOK**

Durable aluminum broiler comes with wok and lid.



ITEM	DESCRIPTION	U/M	WEIGHT GROSS lbs	INNER PACK	MASTER PACK	CU. FT.
CETW001	6"	EACH	17.09	1	10	0.68
CETW002	7"	EACH	25.35	1	10	1.10
CETW003	8"	EACH	27.56	1	10	1.40
CETW004	9"	EACH	34.17	1	10	1.70
CETW005	10"	EACH	52.91	1	10	2.92



IRTP001, IRTP002

**BBQ PLATE (CAST IRON)**

Heavy-duty cast iron plate with concave shape to fit exactly on burner. Ridges added for attractive grilled texture on tortillas, pita breads, etc.

ITEM	DESCRIPTION	U/M	WEIGHT GROSS lbs	INNER PACK	MASTER PACK	CU. FT.
IRTP001	11 1/2" BBQ Plate	EACH	41.89	1	6	1.22
IRTP002	10 1/4" BBQ Plate	EACH	44.53	1	8	1.06



## ALUMINUM STEAMERS

A complete set of four parts, with bottom, two middle perforated stacks, and lid. Handles built into all sides of all compartments for safe handling while hot. Efficiently steams vegetables and other ingredients.

\*Larger sizes ALST013 through ALST016, come without bottom.



Aluminum

Made in Taiwan



MIDDLE

LID

BOTTOM

ALUMINUM  
STEAMER  
COMPLETE SET

ALST001~012

ALST013~016

ITEM	DESCRIPTION	U/M	WEIGHT GROSS lbs	INNER PACK	MASTER PACK	CU. FT.
<b>Small Hole Steamers with Bottom and Lid (Hole size: <math>\frac{1}{8}</math>" )</b>						
ALST001	11 $\frac{3}{8}$ " x 12 $\frac{1}{2}$ "	SET	2.43	1	1	0.79
ALST003	11 $\frac{1}{2}$ " x 14 $\frac{1}{2}$ "	SET	2.86	1	1	0.85
ALST005	13" x 19 $\frac{1}{2}$ "	SET	3.75	1	1	1.37
ALST007	15" x 20 $\frac{1}{4}$ "	SET	4.52	1	1	1.76
<b>Big Hole Steamers with Bottom and Lid (Hole size: <math>\frac{3}{8}</math>" )</b>						
ALST002	11 $\frac{3}{8}$ " x 12 $\frac{1}{2}$ "	SET	2.43	1	1	0.80
ALST004	11 $\frac{1}{2}$ " x 14 $\frac{1}{2}$ "	SET	2.86	1	1	0.85
ALST006	13" x 19 $\frac{1}{2}$ "	SET	3.75	1	1	1.37
ALST008	15" x 20 $\frac{1}{4}$ "	SET	4.52	1	1	1.81
ALST010	17" x 21 $\frac{1}{2}$ "	SET	6.00	1	1	2.37
ALST011	19" x 22 $\frac{5}{8}$ "	SET	7.94	1	1	3.11
ALST012	21" x 25 $\frac{1}{2}$ "	SET	12.57	1	1	3.01
<b>Steamers without Bottom, Heavy Duty</b>						
ALST013	19 $\frac{1}{2}$ " x 18"	SET	12.79	1	1	3.80
ALST014	22" x 21"	SET	14.55	1	1	4.70
ALST015	23" x 19"	SET	17.64	1	1	5.80
ALST016	26" x 22"	SET	19.40	1	1	7.60

**BURNER**

High-powered Jet Burners and Duck Burners. Power ranges from 62,000 to 160,000 BTU. Replacement nozzles available separately.



Jet Burner



Duck Burner

Jet Burner Nozzle  
IRBN001L, IRBN001N



Duck Burner Nozzle  
IRBN002L, IRBN002N

Jet Burner Pin  
IRBN003N



ITEM	DESCRIPTION	U/M	WEIGHT GROSS lbs	INNER PACK	MASTER PACK	CU. FT.
<b>JET BURNER</b>						
IRBR001L	20 Burner - Propane	EACH	41.89	8	8	0.80
IRBR001N	20 Burner - Natural Gas	EACH	41.89	8	8	0.80
IRBR002CL	23 Burner - Propane	EACH	44.53	8	8	1.12
IRBR002CN	23 Burner - Natural Gas	EACH	44.53	8	8	1.12
IRBR002L	23 Burner - Propane	EACH	40.70	8	8	0.50 <span>Made in Taiwan</span>
IRBR002N	23 Burner - Natural Gas	EACH	40.70	8	8	0.50 <span>Made in Taiwan</span>
IRBR003CL	32 Burner - Propane	EACH	41.89	5	5	1.31
IRBR003CN	32 Burner - Natural Gas	EACH	41.89	5	5	1.31
IRBR003L	32 Burner - Propane	EACH	42.99	5	5	0.95 <span>Made in Taiwan</span>
IRBR003N	32 Burner - Natural Gas	EACH	42.99	5	5	0.95 <span>Made in Taiwan</span>
<b>DUCK BURNER</b>						
IRBR004CL	18 Burner - Propane	EACH	41.89	6	6	1.04
IRBR004CN	18 Burner - Natural Gas	EACH	41.89	6	6	1.04
IRBR004L	18 Burner - Propane	EACH	42.99	6	6	0.94 <span>Made in Taiwan</span>
IRBR004N	18 Burner - Natural Gas	EACH	42.99	6	6	0.94 <span>Made in Taiwan</span>

**\*\* Sold by Master Pack Only \*\***

**BURNER NOZZLE**

ITEM	DESCRIPTION	U/M	WEIGHT GROSS lbs	INNER PACK	MASTER PACK	CU. FT.
IRBN001L	Jet Burner - Propane	EACH	45.19	100	1000	0.54
IRBN001N	Jet Burner - Natural Gas	EACH	45.19	100	1000	0.54
IRBN002L	Duck Burner - Propane	EACH	44.09	50	250	0.50
IRBN002N	Duck Burner - Natural Gas	EACH	44.09	50	250	0.50
IRBN003N	Jet Burner Pin, 5pc/pack	PACK	1.65	1	100	0.13 <span>Made in Taiwan</span>

### FAST STOVE

Heavy-duty Fast Stove, built with burner that can quickly be adjusted to low and high settings. It will not scorch meals while cooking. Comes with hose and gas nozzle.

**PROPANE ONLY.**

ITEM	DESCRIPTION	U/M	WEIGHT GROSS lbs	INNER PACK	MASTER PACK	CU. FT.
IRFS001	5B, 76,800 BTU	EACH	20.94	1	1	1.19
IRFS002	HL-202, 16,800 BTU	EACH	16.43	1	1	0.75
IRFS003	5A (Copper Nozzle), 91,200 BTU	EACH	20.94	1	1	1.20
H-205	5B-Automatic, 64,800 BTU	EACH	22.75	1	1	1.13

#### Fast Stove Parts

IRFS004	5½" x ¾" x 2¾" Aluminum	EACH	35.27	50	200	0.64
---------	-------------------------	------	-------	----	-----	------



IRFS001



IRFS002



IRFS004



H-205



IRFS003

### INSULATED SUSHI RICE POT

Keeps sushi rice moist without the need for electricity. Stainless steel top cover and lining. Easy to clean. Holds moisture in. Wood grain finish.



#### Wood Grain Exterior

ITEM	DESCRIPTION	U/M	WEIGHT GROSS lbs	INNER PACK	MASTER PACK	CU. FT.
SEJ71000	40 Cups	EACH	15.00	1	1	2.42
SEJ73000	60 Cups	EACH	17.00	1	1	2.81

SEJ71000, SEJ73000



#### Stainless Steel Exterior

ITEM	DESCRIPTION	U/M	WEIGHT GROSS lbs	INNER PACK	MASTER PACK	CU. FT.
SEJ72000	40 Cups	EACH	15.00	1	1	2.42
SEJ74000	60 Cups	EACH	17.00	1	1	2.81

SEJ72000, SEJ74000



# ASIAN TABLEWARE



ASIAN TABLEWARE

## BAMBOO SOUP SPOON

Soup spoon made with bamboo handle. Easy to wash and maintain.



ITEM	DESCRIPTION	U/M	WEIGHT GROSS lbs	INNER PACK	MASTER PACK	CU. FT.
30-27	4" x 11"	EACH	44.00	40	480	4.06
30-28	3" x 8½"	EACH	30.80	40	480	4.39
30-55	3" x 8½"	EACH	30.80	40	480	4.25

## DONBURI BOWL WITH LADLE

Japanese style, comes with bowl, lid, and ladle. Excellent for soup and noodle.

Made in Taiwan



ITEM	DESCRIPTION	U/M	WEIGHT GROSS lbs	INNER PACK	MASTER PACK	CU. FT.
PLNB001	30 oz, 6" Diameter, Red	EACH	39.60	1	60	5.80
PLNB002	30 oz, 6" Diameter, Black	EACH	39.60	1	60	5.80

## WOOD MISO & RICE BOWL

Assorted rice and miso soup bowls. Wood carved with clear finish for protection.



45-1



45-2



45-3



45-4



45-5



45-8



45-35

ITEM	DESCRIPTION	U/M	WEIGHT GROSS lbs	INNER PACK	MASTER PACK	CU. FT.
45-1	16½ oz, 5½" x 4¾"	DOZEN	33.01	0.5	6	4.13
45-2	10½ oz, 4¼" x 2½"	DOZEN	28.88	1	12	2.77
45-3	9 oz, 4" x 2½"	DOZEN	33.32	1	12	4.63
45-4	9 oz, 4¾" x 2¼"	DOZEN	33.01	1	12	3.07
45-5	9 oz, 4¾" x 2¼"	DOZEN	34.59	1	12	3.22
45-8	9 oz, 4" x 2½"	DOZEN	30.15	1	12	2.59
45-35	9 oz, 3¾" x 2¾"	DOZEN	36.18	1	12	3.57

## PLASTIC SUSHI PARTY TRAY

Container to accommodate large quantities of sushi. Ideal for use at parties or to accommodate large crowds serving.

ITEM	DESCRIPTION	U/M	WEIGHT GROSS lbs	INNER PACK	MASTER PACK	CU. FT.
PLSPT0802	8½" x 2¾"	EACH	18.10	1	18	1.84
PLSPT0902	9½" x 2¼"	EACH	22.44	1	18	2.78
PLSPT1102	11¾" x 2¾"	EACH	29.67	1	18	4.82



## HAND ROLL RACK

Convenient rack to hold sushi rolls. Accommodates 3, 5, or 10 rolls at once.

Made in Taiwan

ABS

ITEM	DESCRIPTION	U/M	WEIGHT GROSS lbs	INNER PACK	MASTER PACK	CU. FT.
29	7" x 4" x 3¼" 3 Cavities	EACH	12.80	1	60	3.30
30	10¼" x 4¼" x 3¼" 5 Cavities	EACH	11.90	1	40	3.50
53	8½" x 8½" x 4⅞" 10 Cavities	EACH	14.30	1	24	3.80

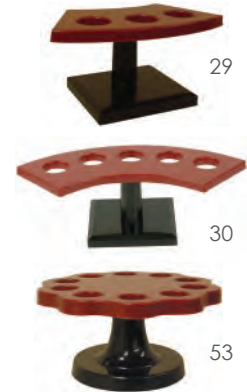

## OBON SERVING TRAY

Japanese Lacquer Ware with coated finish to resist water and moisture.

Made in Taiwan

ITEM	DESCRIPTION	U/M	WEIGHT GROSS lbs	INNER PACK	MASTER PACK	CU. FT.
PLA013	13" x 9½"	EACH	59.40	12	72	4.20
PLA016	15½" x 11½"	EACH	81.60	12	84	3.20



PLA013

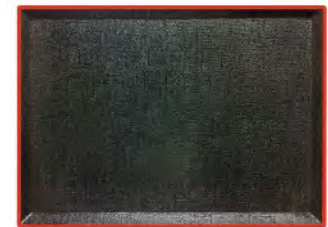

PLA016

## MAKUNOUCHI BENTO BOX

Japanese style lunch box with decorative exterior. Comes with removable inner tray or fixed interior. Separate compartments for each item.

Made in Taiwan

ITEM	DESCRIPTION	U/M	WEIGHT GROSS lbs	INNER PACK	MASTER PACK	CU. FT.
JPRB001	10⅝" x 8⅜" x 3½" w/ Removable Trays	EACH	48.18	1	24	4.80
JPRB002	10⅝" x 8⅜" x 3½"	EACH	35.64	1	24	4.80

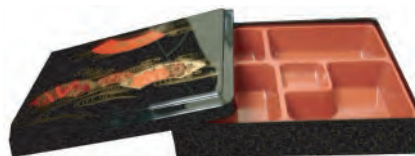

JPRB001



JPRB002



WOBR43  
WOBR57

**WOOD BRIDGE**

Decorative platter for assorted recipes. Crafted in wood.

ITEM	DESCRIPTION	U/M	WEIGHT GROSS lbs	INNER PACK	MASTER PACK	CU. FT.
WOBR43	17" x 13 <sup>3</sup> / <sub>8</sub> " x 4"	EACH	20.94	1	5	2.90
WOBR57	22 <sup>1</sup> / <sub>2</sub> " x 17 <sup>1</sup> / <sub>2</sub> " x 4 <sup>1</sup> / <sub>2</sub> "	EACH	39.68	1	5	5.50

**WOOD BOAT**

Festive wooden boat to decorate and display assorted recipes.



WOBOAT61  
WOBOAT76  
WOBOAT90

ITEM	DESCRIPTION	U/M	WEIGHT GROSS lbs	INNER PACK	MASTER PACK	CU. FT.
WOBOAT61	24" x 8" x 14"	EACH	48.40	1	6	5.80
WOBOAT76	30" x 9 <sup>1</sup> / <sub>2</sub> " x 16 <sup>3</sup> / <sub>8</sub> "	EACH	24.25	1	4	6.55
WOBOAT90	35 <sup>1</sup> / <sub>2</sub> " x 12" x 7"	EACH	33.00	1	4	9.99

IRPA001



**NABEMONO BOWL (CAST IRON)**

Large stew bowl for hot recipes. Durable cast iron construction. Includes wooden lid and base.

ITEM	DESCRIPTION	U/M	WEIGHT GROSS lbs	INNER PACK	MASTER PACK	CU. FT.
IRPA001	24 oz, 7" Diameter	EACH	52.80	1	18	2.10
IRPA002	32 oz, 7" Diameter	EACH	43.14	1	12	2.01
IRPA003	40 oz, 7 <sup>1</sup> / <sub>2</sub> " Diameter	EACH	55.00	1	8	2.40

IRPA002



IRPA003



IRPA004



**SHABU SHABU NABE BOWL (ALUMINUM ALLOY)**

Use this large Shabu Shabu pot to accommodate for large groups.

ITEM	DESCRIPTION	U/M	WEIGHT GROSS lbs	INNER PACK	MASTER PACK	CU. FT.
IRPA004	32 oz, 7 <sup>5</sup> / <sub>8</sub> " x 7" 9 <sup>3</sup> / <sub>4</sub> "	EACH	52.35	1	36	6.30

### SHIRAKI WOOD SUSHI SERVER

Large sushi server to accommodate large parties servings.

ITEM	DESCRIPTION	U/M	WEIGHT GROSS lbs	INNER PACK	MASTER PACK	CU. FT.
Y-55	12½" x 8"	EACH	28.66	1	12	2.18
Y-35	16½" x 10¼"	EACH	39.68	1	10	3.39
Y-15	21½" x 13¼"	EACH	39.68	1	6	4.36



### BAMBOO SUSHI PLATE

Light weight bamboo plate to accommodate single sushi serving plate.

ITEM	DESCRIPTION	U/M	WEIGHT GROSS lbs	INNER PACK	MASTER PACK	CU. FT.
WSPB001	8½" x 4¾" x 1¼"	EACH	17.60	6	24	0.96
WSPB002	9½" x 6" x 1¼"	EACH	21.85	6	24	1.26
WSPB003	10½" x 7" x 1¼"	EACH	24.20	6	24	1.63



### WOOD SUSHI PLATE

Wooden individual sushi plate. Ideal for customers served at shushi bar counter.

ITEM	DESCRIPTION	U/M	WEIGHT GROSS lbs	INNER PACK	MASTER PACK	CU. FT.
WSPW001	8½" x 4¾" x 2¼"	EACH	22.05	6	24	1.76
WSPW002	9½" x 6" x 2¼"	EACH	26.46	6	24	2.43
WSPW003	10½" x 7" x 2¼"	EACH	27.56	6	24	3.24



### SHIRAKI WOOD SHOYU HOLDER

Shiraki wood made dispenser for soy sauce and condiment dispensers. Compact and decorative.

ITEM	DESCRIPTION	U/M	WEIGHT GROSS lbs	INNER PACK	MASTER PACK	CU. FT.
Y-75	9" x 5"	EACH	24.25	6	36	1.74
Y-95	8" x 4½"	EACH	24.25	6	36	1.59
K109	6½" x 3¾" with Handle	EACH	30.86	7	42	2.80



### TOOTHPICKS

Round toothpicks made of bamboo. Packed.

ITEM	DESCRIPTION	U/M	WEIGHT GROSS lbs	INNER PACK	MASTER PACK	CU. FT.
BATP001	Bamboo Tooth Pick, 10 Bag/Pack	PACK	25.60	1	50	1.01



SLAL01A  
Wok Set



SLAL01B  
Wok Body



SLAL005  
Base Only

**ALCOHOL WOK**

Stainless steel woks with stand to keep meals nice and hot. Wok includes handles and lid.

ITEM	DESCRIPTION	U/M	WEIGHT GROSS lbs	INNER PACK	MASTER PACK	CU. FT.
SLAL01A	7½" Alcohol Wok Set	SET	41.89	1	24	4.08
SLAL02A	9" Alcohol Wok Set	SET	68.20	1	24	5.14
SLAL03A	10" Alcohol Wok Set	SET	58.42	1	24	6.33
SLAL04A	11" Alcohol Wok Set	SET	62.83	1	24	8.20
SLAL01B	7½" Alcohol Wok Body	EACH	59.40	6	72	5.09
SLAL02B	9" Alcohol Wok Body	EACH	68.30	6	48	5.03
SLAL03B	10" Alcohol Wok Body	EACH	68.34	6	48	4.87
SLAL04B	11" Alcohol Wok Body	EACH	77.16	6	48	6.43
SLAL005	Alcohol Wok Base	EACH	48.50	1	80	5.01

**OVAL FISH PLATTER**

Wok set comes with oval steel platter. Lever handle allows easy control of flames.



SLFD001, SLFD002



ITEM	DESCRIPTION	U/M	WEIGHT GROSS lbs	INNER PACK	MASTER PACK	CU. FT.
SLFD001	14"	EACH	57.76	1	24	9.86
SLFD002	16"	EACH	69.22	1	24	13.02



**CHAFING WOK SET**

Steel wok set comes with lid and base. Heating compartment to keep meals hot.



SLFM001

ITEM	DESCRIPTION	U/M	WEIGHT GROSS lbs	INNER PACK	MASTER PACK	CU. FT.
SLFM001	7" x 7¼" Wok Set	SET	41.80	1	30	5.50



## RICE CONTAINER

Keep your rice warm and moist with an insulated container. Constructed with light weight plastic. Container for rice with lid. Replacement lid also available.

### Insulated

ITEM	DESCRIPTION	U/M	WEIGHT GROSS lbs	INNER PACK	MASTER PACK	CU. FT.
T-111	64 oz, Rice Container, w/ handle. Spoon Included	SET	28.00	1	12	2.43
T-111C	Rice Container Cover Fits T-111 and T-333	EACH	32.63	12	72	2.82



### Regular

ITEM	DESCRIPTION	U/M	WEIGHT GROSS lbs	INNER PACK	MASTER PACK	CU. FT.
P-222	72 oz, 7½" Rice Container	SET	19.25	1	12	2.67
T-333	72 oz, Rice Container w/ handle. Spoon Included	SET	21.61	1	12	2.35



## RICE SCOOP

A simple hand tool for scooping rice from container. Durable and easy to clean.

ITEM	DESCRIPTION	U/M	WEIGHT GROSS lbs	INNER PACK	MASTER PACK	CU. FT.
PLRS001	Plastic Rice Scoop	EACH	33.07	50	500	1.55
PLRS003	10½" Plastic Jumbo Rice Scoop	EACH	21.67	24	120	1.79



## PHO BOWL – MELAMINE



### Ivory

ITEM	DESCRIPTION	U/M	WEIGHT GROSS lbs	INNER PACK	MASTER PACK	CU. FT.
PH5005V	19 oz, 5⅞" x 2¼"	DOZEN	37.25	1	6	1.65
PH5007V	38 oz, 7⅞" x 2¾"	DOZEN	38.06	1	4	2.26
PH5008V	58 oz, 8¼" x 3¼"	DOZEN	42.02	1	3	3.16
PH5010V	88 oz, 9¼" x 3⅞"	DOZEN	46.95	1	2	2.78



### White

ITEM	DESCRIPTION	U/M	WEIGHT GROSS lbs	INNER PACK	MASTER PACK	CU. FT.
PH5005TW	19 oz, 5⅞" x 2¼"	DOZEN	37.25	1	6	1.65
PH5007TW	38 oz, 7⅞" x 2¾"	DOZEN	38.06	1	4	2.26
PH5008TW	58 oz, 8¼" x 3¼"	DOZEN	42.02	1	3	3.16
PH5010TW	88 oz, 9¼" X 3⅞"	DOZEN	46.95	1	2	2.78





10" Red



12" Blue



14" Light Green



16" Red

**FISH PLATTER (MELAMINE)**

Festive fish shaped platter.



ITEM	DESCRIPTION	U/M	WEIGHT GROSS lbs	INNER PACK	MASTER PACK	CU. FT.
1000CFB	10" - Blue	DOZEN	19.11	0.5	3	1.47
1000CFG	10" - Light Green	DOZEN	19.11	0.5	3	1.47
1000CFR	10" - Red	DOZEN	19.11	0.5	3	1.47
1200CFB	12" - Blue	DOZEN	26.04	0.5	3	2.12
1200CFG	12" - Light Green	DOZEN	26.04	0.5	3	2.12
1200CFR	12" - Red	DOZEN	26.04	0.5	3	2.12
1400CFB	14" - Blue	DOZEN	30.03	0.25	2	2.97
1400CFG	14" - Light Green	DOZEN	30.03	0.25	2	2.97
1400CFR	14" - Red	DOZEN	30.03	0.25	2	2.97
1600CFB	16" - Blue	DOZEN	38.85	0.25	2	3.90
1600CFG	16" - Light Green	DOZEN	38.85	0.25	2	3.90
1600CFR	16" - Red	DOZEN	38.85	0.25	2	3.90

**JAPANESE LANTERN**

Festive lanterns for decoration. 16" diameter.



HL-22



HL-23



HL36-2

ITEM	DESCRIPTION	U/M	WEIGHT GROSS lbs	INNER PACK	MASTER PACK	CU. FT.
HL-22	Red, Fortune	EACH	22.46	12	96	5.88
HL-23	Red, Longevity	EACH	22.46	12	96	5.88
HL36-2	Geisha	EACH	30.29	12	96	9.88

**WELCOME MAT**

Festive red mat to invite guests. Works in all kinds of weather.

ITEM	DESCRIPTION	U/M	WEIGHT GROSS lbs	INNER PACK	MASTER PACK	CU. FT.
PLWC001	54" x 34" Welcome Mat	EACH	70.40	12	12	4.00



PLWC001



## CHOPSTICKS

Bag sealed chopsticks. Made of selective bamboo, plastics and melamine for various choices. 1,000 Pairs/Case

ITEM	DESCRIPTION	U/M	WEIGHT GROSS lbs	INNER PACK	MASTER PACK	CU. FT.
BACS002	45 cm Long Chopsticks	PAIR	22.05	50	500	2.07
PLCS001	Dragon Chopsticks	CASE	66.00	1	1	1.11
PLCS002	White Chopsticks	CASE	66.00	1	1	1.11
PLCS003	Red Chopsticks	CASE	66.00	1	1	1.11
MLCS001	Melamine Chopsticks White	CASE	66.00	1	1	1.10
MLCS002	Melamine Chopsticks Yellow	CASE	66.00	1	1	1.10
MLCS001B	Melamine Chopsticks Black	CASE	66.00	1	1	1.10
MLCS001G	Melamine Chopsticks Green	CASE	66.00	1	1	1.10



BACS002

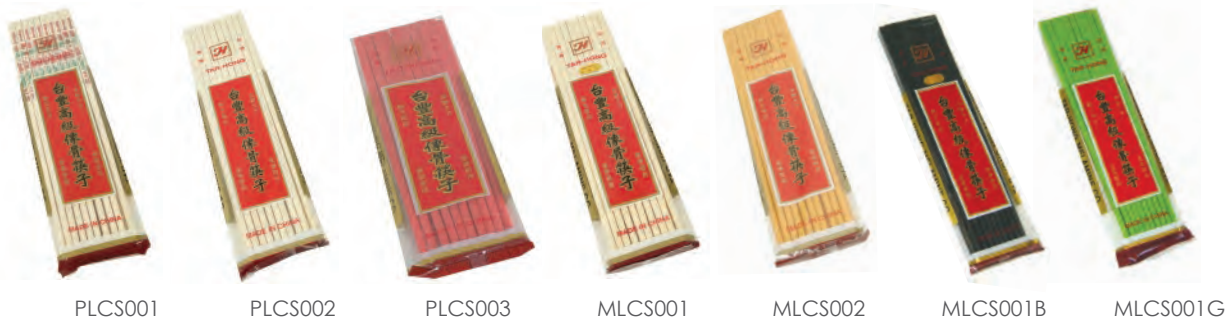

\*Sold by Master Pack Only

## CHOPSTICKS HOLDER

Plastic vertical chopstick holders. Available in black, ivory, and stainless steel.

ITEM	DESCRIPTION	U/M	WEIGHT GROSS lbs	INNER PACK	MASTER PACK	CU. FT.
PLCH001-B	Black	EACH	28.60	1	24	3.20
PLCH001-I	Ivory	EACH	28.60	1	24	3.20
SLCH007	Stainless Steel	EACH	37.48	1	24	2.81



PLCH001-B



PLCH001-I



SLCH007

## SUSHI ROLLER

Bamboo rolling tool for Sushi hand rolls. Compact and easy to use.

ITEM	DESCRIPTION	U/M	WEIGHT GROSS lbs	INNER PACK	MASTER PACK	CU. FT.
BASR095JP	9½" x 9½" - Flat	EACH	44.09	10	200	1.63
BASR195JP	9½" x 9½" - Round	EACH	24.25	10	200	1.54



BASR095JP



BASR195JP



BASR095JP



BASR195JP



## Pizza Supplies

- |                  |        |
|------------------|--------|
| Dough Boxes      | p. 248 |
| Pizza Tray       | p. 199 |
| Pizza Peels      | p. 200 |
| Pizza Screen     | p. 199 |
| Pizza Bags       | p. 200 |
| Pizza Stands     | p. 327 |
| Cheese Dispenser | p. 320 |
| Pizza Cutter     | p. 200 |
| Pan Grip         | p. 200 |

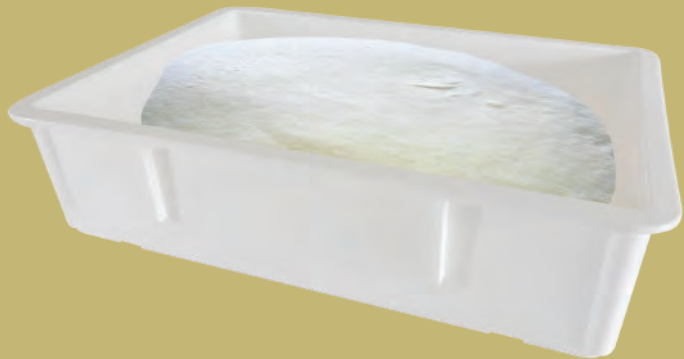



# BAKEWARE & SUPPLIES

2023

ALBA0214



ALBA0312



Handles



## BAKE PAN

ALUMINUM

ITEM	DESCRIPTION	U/M	WEIGHT GROSS lbs	INNER PACK	MASTER PACK	CU. FT.
ALBA0214	26 1/4" x 18 1/4" x 2 1/4"	EACH	44.98	1	12	1.79
ALBA0312	26 1/4" x 18 1/4" x 3 1/4" with Handles	EACH	30.87	1	6	2.48

CARBON STEEL NON-STICK



SLKMP012



SLKMP024



SLKMP124

ALUMINUM



ALKMP012



ALKMP024

## MUFFIN PAN

Multiple usage include food storage and food preparation. Smooth surface for easy cleaning and maintenance.

ITEM	DESCRIPTION	U/M	WEIGHT GROSS lbs	INNER PACK	MASTER PACK	CU. FT.
<b>Aluminum</b>						
ALKMP012	3 1/2 oz, 12 cup	EACH	31.97	12	24	1.40
ALKMP024	3 1/2 oz, 24 cup	EACH	26.00	12	12	1.44
<b>Carbon Steel, Non-Stick</b>						
SLKMP012	3 1/2 oz, 12 cup	EACH	28.66	1	24	1.41
SLKMP024	3 1/2 oz, 24 cup	EACH	30.78	1	12	2.00
SLKMP124	1 1/2 oz, 24 cup	EACH	28.66	1	24	1.37

BAKEWARE & SUPPLIES

**SHEET PAN**

With galvanized wire, perfect for all baking needs.



TRUE GAUGE	ITEM	DESCRIPTION	U/M	WEIGHT GROSS lbs	INNER PACK	MASTER PACK	CU. FT.
	ALSP1006	10" x 6" Eighth Size	EACH	40.73	12	72	1.43
	ALSP1013	9½" x 13" Quarter Size	EACH	26.06	24	24	0.78
	ALSP1622	16" x 22" Two-thirds Size	EACH	25.31	12	12	1.34
	ALSP1813	18" x 13" Half Size	EACH	20.06	12	12	0.86
	ALSP1826	18" x 26" Full Size	EACH	34.70	12	12	1.91
	ALSP1826M	18" x 26" Full Size Pan	EACH	38.08	12	12	1.91
	ALSP1826H	18" x 26" Full Size Pan	EACH	42.97	12	12	1.91
	ALSP1826S	18" x 26" Full Size Pan	EACH	55.93	12	12	1.94
<b>Perforated</b>							
	ALSP1813PF	18" x 13" Half Size, Perforated	EACH	19.75	12	12	0.86
	ALSP1826PF	18" x 26" Full Size, Perforated	EACH	34.61	12	12	1.91
	ALSP1813PG	18" x 13" Half Size, Fully Perforated	EACH	20.98	12	12	0.94
	ALSP1826PG	18" x 26" Full Size, Fully Perforated	EACH	35.48	12	12	1.91
	ALSP1826HPF	18" x 26" Perforated Full Size Pan	EACH	39.50	12	12	1.91
<b>Non-Stick</b>							
	ALSP1813D	18" x 13" Half Size	EACH	23.44	12	12	0.94
	ALSP1826D	18" x 26" Full Size	EACH	39.32	12	12	1.91



**SHEET PAN**

Open bead edge is easy to clean.



ITEM	DESCRIPTION	U/M	WEIGHT GROSS lbs	INNER PACK	MASTER PACK	CU. FT.
SLSP1813	18" x 13" Half Size Sheet, 18/8 Stainless Steel	EACH	17.46	6	6	0.46
SLSP1826	18" x 26" Full Size Sheet, 18/8 Stainless Steel	EACH	35.36	6	6	1.02



\*open bead design

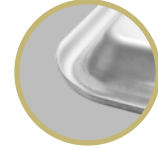

**SHEET PAN COVER – POLYPROPYLENE**

ITEM	DESCRIPTION	U/M	WEIGHT GROSS lbs	INNER PACK	MASTER PACK	CU. FT.
PLSP1013C	9½" x 13" Quarter Size	EACH	10.34	12	24	1.32
PLSP1813C	18" x 13" Half Size	EACH	25.00	12	36	2.34
PLSP1826C	18" x 26" Full Size	EACH	45.00	12	36	5.86



(Cover & Pan are sold separately)



PLSP1826C



PLSP1813C



PLSP1013C

**ALUMINUM SHEET PAN TRUCK**

- 14 gauge 6063 aluminum with 1" extruded aluminum tube frame
- Full swivel casters 5" diameter x 1¼" width
- Capacity: up to 54 full size (18" x 26") or 108 half size (18" x 13") sheet pans
- Overall Size 20¾" W x 28¼" D x 33¾" H
- Ships knocked down



ALSC1826  
Sheet Pans Sold Separately



PLCB5150



ITEM	DESCRIPTION	U/M	WEIGHT GROSS lbs	INNER PACK	MASTER PACK	CU. FT.
ALSC1826	Full Size Aluminum Sheet Pan Truck w/four 5" Swivel Casters	SET	22.66	1	1	1.87
PLCB5150	Replacement 5" Swivel Caster For ALSC1826	EACH	28.11	1	18	1.41

## PAN RACK

Rack with cross supports.

10 tier rack holds 10 full-size pans, or 20 half-size pans.

20 tier rack holds 20 full-size pans, or 40 half-size pans.

2 large locking casters and 2 regular casters for easy transport are included.

Clear cover is also available separately.



ITEM	DESCRIPTION	U/M	WEIGHT GROSS lbs	INNER PACK	MASTER PACK	CU. FT.
ALSPR010	10-Tier 20¼" x 26" x 38½"	SET	20.64	1	1	2.26
ALSPR020	20-Tier 20¼" x 26" x 69¼"	SET	32.86	1	1	4.18
<b>Pan Rack Accessories</b>						
PLRC005	5" Caster	EACH	16.70	1	12	0.50
PLRC005B	5" Locking Caster	EACH	19.28	1	12	0.59
PLPRC020	20-Tier Pan Rack Cover - Clear	EACH	49.20	1	12	1.85

**\* Shipped Freight Only - No UPS \***





**DOUGH PAN/ PIE PAN**



ALUMINUM



ALDP048  
ALDP048c  
ALDP096  
ALDP096c



ALPN009  
ALPN010  
ALPN011  
ALPN012



ITEM	DESCRIPTION	U/M	WEIGHT GROSS lbs	INNER PACK	MASTER PACK	CU. FT.
<b>Dough Pan</b>						
ALDP048	48 oz Dough Pan, 8" Diameter x 2½" Stackable	EACH	27.31	12	48	5.04
ALDP048C	Dough Pan Cover For ALDP048,	EACH	26.72	12	120	1.34
ALDP096	96 oz Dough Pan, 9" Diameter x 3¾" Stackable	EACH	28.31	12	48	7.01
ALDP096C	Dough Pan Cover For ALDP096,	EACH	34.26	12	120	1.70
<b>Pie Pan</b>						
ALPN009	9" Pie Pan	EACH	31.38	12	72	1.75
ALPN010	10" Pie Pan	EACH	34.71	12	72	2.31
ALPN011	11" Pie Pan	EACH	41.05	12	72	2.49
ALPN012	12" Pie Pan	EACH	49.17	12	72	2.92

**PIE MARKER**

Portion control. For pie or cake cutting.



ALUMINUM

ITEM	DESCRIPTION	U/M	WEIGHT GROSS lbs	INNER PACK	MASTER PACK	CU. FT.
ALPMA005	5 Cut	EACH	33.07	12	96	8.16
ALPMA006	6 Cut	EACH	34.17	12	96	8.16
ALPMA007	7 Cut	EACH	35.27	12	96	8.16
ALPMA008	8 Cut	EACH	36.38	12	96	8.16
ALPMA009	9 Cut	EACH	38.58	12	96	8.77
ALPMA010	10 Cut	EACH	39.68	12	96	8.77
ALPMA012	12 Cut	EACH	43.50	12	96	8.77



ALPMA008

**PIE SERVER**

Stainless steel blade. Durable and flexible. Sturdy handle made of plastic or wood.

ITEM	DESCRIPTION	U/M	WEIGHT GROSS lbs	INNER PACK	MASTER PACK	CU. FT.
SLTWPS002	6" w/ 3" x 4½" Blade Wood Handle. 11¼" x 3" x 1½"	EACH	40.79	12	120	1.19
SLPS027P	2½" x 4¼" Plastic Handle	EACH	30.86	12	120	1.43



SLTWPS002

SLPS027P

**ROUND LAYER CAKE PAN**

For creating the perfect multi-layer cake.



ITEM	DESCRIPTION	U/M	WEIGHT GROSS lbs	INNER PACK	MASTER PACK	CU. FT.
<b>2" Pan</b>						
ALCP0302	3" Diameter x 2"	EACH	10.71	12	48	0.99
ALCP0602	6" Diameter x 2"	EACH	12.83	6	36	2.30
ALCP0802	8" Diameter x 2"	EACH	21.66	6	36	5.03
ALCP0902	9" Diameter x 2"	EACH	27.94	6	36	5.51
ALCP1002	10" Diameter x 2"	EACH	29.49	6	36	7.03
ALCP1202	12" Diameter x 2"	EACH	36.79	6	36	9.90
ALCP1402	14" Diameter x 2"	EACH	28.17	6	24	6.78
ALCP1602	16" Diameter x 2"	EACH	33.99	6	24	9.09



ITEM	DESCRIPTION	U/M	WEIGHT GROSS lbs	INNER PACK	MASTER PACK	CU. FT.
<b>3" Pan</b>						
ALCP0303	3" Diameter x 3"	EACH	13.89	12	48	1.40
ALCP0603	6" Diameter x 3"	EACH	15.21	6	36	3.22
ALCP0803	8" Diameter x 3"	EACH	25.30	6	36	6.54
ALCP0903	9" Diameter x 3"	EACH	27.96	6	36	7.34
ALCP1003	10" Diameter x 3"	EACH	36.44	6	36	9.15
ALCP1203	12" Diameter x 3"	EACH	44.51	6	36	12.87
ALCP1403	14" Diameter x 3"	EACH	31.35	6	24	9.70
ALCP1603	16" Diameter x 3"	EACH	36.64	6	24	12.83

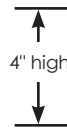

ITEM	DESCRIPTION	U/M	WEIGHT GROSS lbs	INNER PACK	MASTER PACK	CU. FT.
<b>4" Pan</b>						
ALCP1004	10" Diameter x 3"	EACH	13.89	12	48	1.40
ALCP1204	12" Diameter x 3"	EACH	15.21	6	36	3.22
ALCP1404	14" Diameter x 3"	EACH	25.30	6	36	6.54
ALCP1604	16" Diameter x 3"	EACH	27.96	6	36	7.34



**DREDGER**

For dispensing flour, sugar and more.



SLRDH001



SLRDH002



ALRDH001



ALRDH002



PLRDH003

ITEM	DESCRIPTION	U/M	WEIGHT GROSS lbs	INNER PACK	MASTER PACK	CU. FT.	
SLRDH001	10 oz with Handle	EACH	22.00	12	72	1.95	STAINLESS STEEL
SLRDH002	10 oz without Handle	EACH	20.79	12	72	1.95	STAINLESS STEEL
ALRDH001	10 oz Dredge With Handle	EACH	19.10	12	144	3.16	ALUMINUM
ALRDH002	10 oz Dredge Without Handle	EACH	16.88	12	144	3.16	ALUMINUM
PLRDH003	10 oz with 3 Snap-On Lids: Fine, Medium & Large Holes. (Polycarbonate Cup with Polypropylene Lid)	SET	25.30	12	72	3.36	POLYCARBONATE

**LIQUID MEASURE CUP**

With riveted handles. Easy to measure.



ALKAM005



ALKAM010



ALKAM020



ALKAM040



ITEM	DESCRIPTION	U/M	WEIGHT GROSS lbs	INNER PACK	MASTER PACK	CU. FT.
ALKAM005	½ qt	EACH	20.30	1	48	3.31
ALKAM010	1 qt	EACH	17.64	1	36	4.10
ALKAM020	2 qt	EACH	20.94	1	24	4.93
ALKAM040	4 qt	EACH	16.71	1	12	4.07

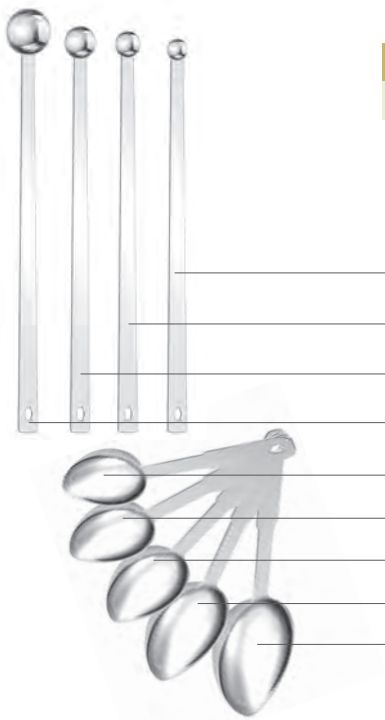

### MEASURING SPOON

Measurements comply with U.S. Standards.



ITEM	DESCRIPTION	U/M	WEIGHT GROSS lbs	INNER PACK	MASTER PACK	CU. FT.
SLMS025L	1/4 tsp, 15 3/4" Long	EACH	21.60	12	144	0.53
SLMS050L	1/2 tsp, 15 3/8" Long	EACH	30.00	12	144	0.53
SLMS100L	1 tsp, 15 1/2" Long	EACH	30.80	12	144	0.91
SLMS150L	1 Tbsp, 16" Long	EACH	31.40	12	144	0.91
SLMS013V	1/8 Cup, 8 3/4" Long	EACH	15.70	12	72	0.21
SLMS025V	1/4 Cup, 8 3/4" Long	EACH	18.40	12	72	0.26
SLMS033V	1/3 Cup, 8 3/4" Long	EACH	22.80	12	72	0.38
SLMS050V	1/2 Cup, 10" Long	EACH	26.20	12	72	0.46
SLMS100V	1 Cup, 11" Long	EACH	27.70	12	72	0.67

### MEASURING SPOON SET & MEASURING CUP SET

Measurements comply with U.S. Standards.



SLMC2414

ITEM	DESCRIPTION	U/M	WEIGHT GROSS lbs	INNER PACK	MASTER PACK	CU. FT.
SLMC2414	1/4, 1/2, 1 Cup	SET	37.48	12	72	1.59
SLMC2415	1/4, 1/2, 1 tsp, 1 Tbsp	SET	30.75	24	288	0.88
SLMC2416	1/4, 1/2, 1 tsp, 1 Tbsp	SET	48.5	24	288	1.13
OW356	1/4, 1/2, 1 tsp, 1 Tbsp	SET	48.40	24	288	1.13



SLMC2415



SLMC2416



OW356

### MEASURING SPOON SET

Measurements comply with U.S. Standards.



ALMC001

ITEM	DESCRIPTION	U/M	WEIGHT GROSS lbs	INNER PACK	MASTER PACK	CU. FT.
ALMC001	1 Tbsp, 1 Tsp, 1/2 Tsp & 1/4 Tsp	SET	23.15	24	288	0.88

**Make baking easier with non-stick silicone baking products**

- Non-stick high heat silicone
- Flexible and unbreakable
- FDA Approved
- Temperature rated -40° to 550° F



PLBM001S

PLBM002S

PLBM003S

PLBM004S

PLBM005S

**SILICONE BAKING MOLD**

ITEM	DESCRIPTION	U/M	WEIGHT GROSS lbs	INNER PACK	MASTER PACK	CU. FT.
PLBM001S	2.7 oz, Hemisphere	EACH	14.06	1	48	3.68
PLBM002S	4.4 oz, Heart	EACH	18.82	1	48	5.57
PLBM003S	4.57 oz, Muffin	EACH	15.64	1	48	3.68
PLBM004S	3.89 oz, Dahlia	EACH	16.90	1	48	3.68
PLBM005S	3.89 oz, Sunflower	EACH	18.38	1	48	3.68

SILICONE BAKING MOLD



PLBM006S      PLBM007S      PLBM008S      PLBM009S      PLBM010S



ITEM	DESCRIPTION	U/M	WEIGHT GROSS lbs	INNER PACK	MASTER PACK	CU. FT.
PLBM006S	1 oz, Madeleine	EACH	14.14	1	48	2.79
PLBM007S	2.1 oz, Savarin	EACH	13.32	1	48	2.79
PLBM008S	2.4 oz, Heart	EACH	15.11	1	48	3.68
PLBM009S	3 oz, Pyramid	EACH	14.27	1	48	3.68
PLBM010S	3.7 oz, Brioche	EACH	13.00	1	48	3.68

SILICONE BAKING MAT

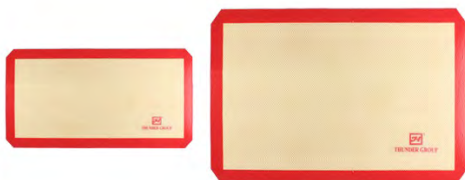

PLBM0804S      PLBM1108S

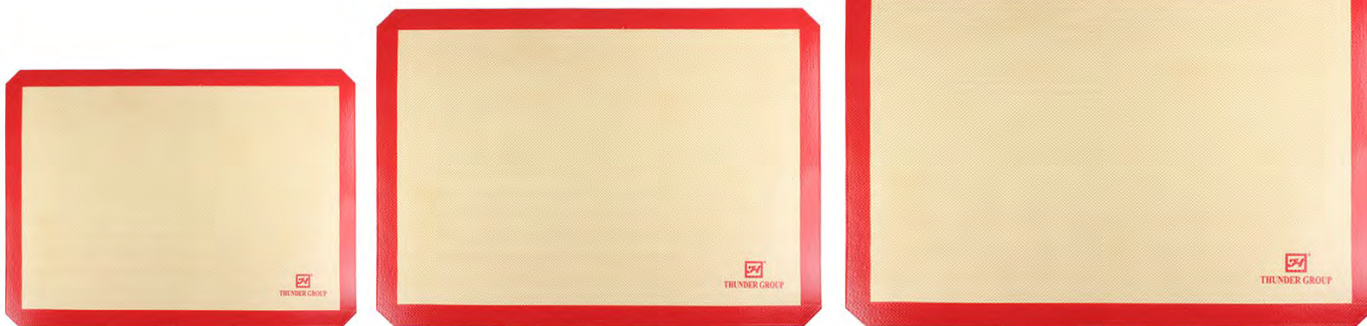

PLBM1216S      PLBM1520S      PLBM1624S

ITEM	DESCRIPTION	U/M	WEIGHT GROSS lbs	INNER PACK	MASTER PACK	CU. FT.
PLBM0804S	4 $\frac{3}{4}$ " x 8 $\frac{3}{4}$ " Rectangular, Fits $\frac{1}{8}$ Sheet Pan	EACH	10.32	12	48	0.11
PLBM1108S	8 $\frac{1}{4}$ " x 11 $\frac{3}{4}$ " Rectangular, Fits $\frac{1}{4}$ Sheet Pan	EACH	13.49	12	48	0.74
PLBM1216S	11 $\frac{7}{8}$ " x 16 $\frac{1}{2}$ " Rectangular, Fits $\frac{1}{2}$ Sheet Pan	EACH	19.52	12	48	1.45
PLBM1520S	14 $\frac{5}{8}$ " x 20 $\frac{1}{2}$ " Rectangular, Fits $\frac{3}{8}$ Sheet Pan	EACH	25.98	12	48	1.75
PLBM1624S	16 $\frac{1}{2}$ " x 24 $\frac{1}{2}$ " Rectangular, Fits $\frac{1}{2}$ Sheet Pan	EACH	34.76	12	48	1.97

## PIZZA TRAY & PIZZA SCREEN



Wide Rim  
ALPTWR008 ~ ALPTWR022



Seamless Rim  
ALPZ08 ~ ALPZ22



Coupe Style  
ALPTCS008 ~ ALPTCS018



ITEM	DESCRIPTION	U/M	WEIGHT GROSS lbs	INNER PACK	MASTER PACK	CU. FT.
<b>Pizza Tray</b>						
ALPTWR008	8" Wide Rim Tray	EACH	40.79	12	168	1.70
ALPTWR009	9" Wide Rim Tray	EACH	50.04	12	168	2.04
ALPTWR010	10" Wide Rim Tray	EACH	61.73	12	168	2.50
ALPTWR011	11" Wide Rim Tray	EACH	72.75	12	168	2.98
ALPTWR012	12" Wide Rim Tray	EACH	61.07	12	120	2.77
ALPTWR013	13" Wide Rim Tray	EACH	28.66	12	48	1.25
ALPTWR014	14" Wide Rim Tray	EACH	33.07	12	48	1.40
ALPTWR015	15" Wide Rim Tray	EACH	39.24	12	48	1.72
ALPTWR016	16" Wide Rim Tray	EACH	44.09	12	48	1.81
ALPTWR017	17" Wide Rim Tray	EACH	49.16	12	48	2.16
ALPTWR018	18" Wide Rim Tray	EACH	56.88	12	48	2.36
ALPTWR019	19" Wide Rim Tray	EACH	31.53	12	24	1.59
ALPTWR020	20" Wide Rim Tray	EACH	34.61	12	24	1.75
ALPTWR022	22" Wide Rim Tray	EACH	41.89	12	24	2.07
<b>Pizza Screen</b>						
ALPZ08	8" Seamless Rim Screen	EACH	24.25	12	168	1.30
ALPZ09	9" Seamless Rim Screen	EACH	28.66	12	168	1.67
ALPZ10	10" Seamless Rim Screen	EACH	33.07	12	168	1.97
ALPZ11	11" Seamless Rim Screen	EACH	37.48	12	168	2.34
ALPZ12	12" Seamless Rim Screen	EACH	27.60	12	120	2.82
ALPZ13	13" Seamless Rim Screen	EACH	15.40	12	48	0.97
ALPZ14	14" Seamless Rim Screen	EACH	15.84	12	48	1.27
ALPZ15	15" Seamless Rim Screen	EACH	16.72	12	48	1.37
ALPZ16	16" Seamless Rim Screen	EACH	18.48	12	48	1.54
ALPZ17	17" Seamless Rim Screen	EACH	20.33	12	48	1.61
ALPZ18	18" Seamless Rim Screen	EACH	22.13	12	48	2.24
ALPZ19	19" Seamless Rim Screen	EACH	14.00	12	24	1.12
ALPZ20	20" Seamless Rim Screen	EACH	14.99	12	24	1.24
ALPZ22	22" Seamless Rim Screen	EACH	15.00	12	24	1.53
<b>Coupe Tray</b>						
ALPTCS008	8" Coupe Style Tray	EACH	40.74	12	168	1.79
ALPTCS009	9" Coupe Style Tray	EACH	49.69	12	168	2.08
ALPTCS010	10" Coupe Style Tray	EACH	60.80	12	168	2.51
ALPTCS011	11" Coupe Style Tray	EACH	72.53	12	168	3.05
ALPTCS012	12" Coupe Style Tray	EACH	61.07	12	120	2.63
ALPTCS013	13" Coupe Style Tray	EACH	28.57	12	48	1.41
ALPTCS014	14" Coupe Style Tray	EACH	32.54	12	48	1.49
ALPTCS015	15" Coupe Style Tray	EACH	37.39	12	48	1.69
ALPTCS016	16" Coupe Style Tray	EACH	41.71	12	48	1.82
ALPTCS017	17" Coupe Style Tray	EACH	46.83	12	48	1.99
ALPTCS018	18" Coupe Style Tray	EACH	51.37	12	48	2.22



PLPB018

**PIZZA BAG**

Insulated bag with Velcro fasteners and holes for ventilation. The exterior is made out of durable Leatheroid PVC (a synthetic leather) with nylon edges. The interior is constructed of 1" foam insulation for better heat retention. T-strap for easy handling.

ITEM	DESCRIPTION	U/M	WEIGHT GROSS lbs	INNER PACK	MASTER PACK	CU. FT.
PLPB018	18" x 18" Holds 2 of 16" Pizza	EACH	17.42	1	12	4.58
PLPB020	20" x 20" Holds 2 of 18" Pizza	EACH	21.16	1	12	5.56
PLPB024	24" x 24" Holds 2 of 22" Pizza	EACH	27.78	1	12	7.81



**PIZZA PEEL**

Endures heat, scrubbing, and other harsh treatment. Surface area withstands bending and offers a reliable support.

ITEM	DESCRIPTION	U/M	WEIGHT GROSS lbs	INNER PACK	MASTER PACK	CU. FT.
<b>Aluminum with Wood Handle</b>						
ALWDPP2512	12" x 14" Blade, 25" Overall Length, 12" Handle	EACH	27.94	12	24	1.51
ALWDPP3012	12" x 14" Blade, 30" Overall Length, 16 7/8" Handle	EACH	31.90	12	24	1.87
ALWDPP3512	12" x 14" Blade, 35" Overall Length, 22" Handle	EACH	34.40	12	24	2.14
ALWDPP5212	12" x 14" Blade, 52" Overall Length, 38" Handle	EACH	38.50	12	24	2.98
<b>Wood</b>						
WDPP1222	12" x 14" Blade, 22" Overall Length, 8 1/4" Handle	EACH	19.84	1	12	0.98
/DPP1236	12" X 14" Blade, 36" Overall Length, 22 1/4" Handle	EACH	28.66	1	12	1.61
VDPP1242	12" X 14" Blade, 42" Overall Length, 28 3/4" Handle	EACH	29.98	1	12	1.87
VDPP1424	14" x 16" Blade, 24" Overall Length, 8 3/8" Handle	EACH	30.86	1	12	1.26
WDPP1436	14" x 16" Blade, 36" Overall Length, 20 3/8" Handle	EACH	33.95	1	12	1.82
WDPP1442	14" x 16" Blade, 42" Overall Length, 26 3/8" Handle	EACH	35.27	1	12	2.18
WDPP1642	16" x 18" Blade, 42" Overall Length, 24 3/4" Handle	EACH	22.05	1	6	1.25
WDPP1842	18" x 18" Blade, 42" Overall Length, 22 1/8" Handle	EACH	47.18	1	12	2.78
WDPP2042	20" x 21" Blade, 42" Overall Length, 20 3/8" Handle	EACH	28.66	1	6	1.56

**PIZZA ACCESSORIES**



ITEM	DESCRIPTION	U/M	WEIGHT GROSS lbs	INNER PACK	MASTER PACK	CU. FT.
<b>Pizza Server</b>						
SLTWPS005	3" x 4 1/4" Blade Wood Handle, 10" x 2 1/4" x 2 1/4"	EACH	39.00	12	180	1.25
SLTWPS006	2 1/2" x 5" Blade Wood Handle, 10 1/4" x 2 1/8" x 1 1/4"	EACH	30.64	12	144	0.89
<b>Pizza Cutter</b>						
SLTWPC002	2 1/2" Wheel Plastic Handle, 8 3/4" x 3 3/4" x 7/8"	EACH	42.90	12	120	1.18
SLTWPC004	4" Wheel Plastic Handle, 9 1/4" x 4 1/2" x 7/8"	EACH	44.09	12	120	2.05
<b>Pan Grips</b>						
ALPG008H	Heavy Duty, Aluminum, 7 7/8" x 1 1/4" x 6 1/2"	EACH	18.80	12	48	0.78
SLPG008D	For Deep Dish, Steel, 7 3/8" x 1 1/2" x 2 3/4"	EACH	22.70	6	60	0.95
SLPG008S	For Shallow Pan, Steel, 7 7/8" x 1 1/2" x 2 3/4"	EACH	22.50	6	60	0.97



**ROLLING PIN**

ITEM	DESCRIPTION	U/M	WEIGHT GROSS lbs	INNER PACK	MASTER PACK	CU. FT.
<b>Aluminum</b>						
ALRNP013	13"	EACH	22.90	1	6	1.02
ALRNP015	15"	EACH	28.50	1	6	1.14
ALRNP018	18"	EACH	33.00	1	6	1.28
<b>Wood</b>						
WDRNP013	13"	EACH	17.60	1	6	0.84
WDRNP015	15"	EACH	18.52	1	6	0.93
WDRNP018	18"	EACH	24.03	1	6	1.01

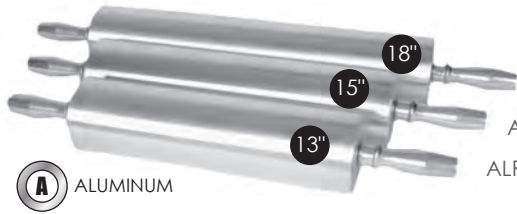

**FLOUR SIFTER**

Mirror-finished body made of stainless steel. Four wire agitator to properly sift flour.



ITEM	DESCRIPTION	U/M	WEIGHT GROSS lbs	INNER PACK	MASTER PACK	CU. FT.
SLFS008	8 Cup	EACH	16.29	1	12	3.25



**ROLLER DOCKER**

Professional rolling docker with sanitary stainless steel handle. Plastic barrel with securely mounted pins.



ITEM	DESCRIPTION	U/M	WEIGHT GROSS lbs	INNER PACK	MASTER PACK	CU. FT.
SLRD008	Plastic Barrel, 8 Wheels	EACH	25.35	1	24	1.98
SLRD020	Half Size Plastic Barrel 3/8" Stainless Pin	EACH	19.84	1	24	1.43
SLRD038	Plastic Barrel, 3/8" Stainless Pin	EACH	28.66	1	24	1.96



**ADJUSTABLE DOUGH DIVIDER & CROISSANT CUTTER**

Made of stainless steel. The dough dividers can be locked for constant widths.

ITEM	DESCRIPTION	U/M	WEIGHT GROSS lbs	INNER PACK	MASTER PACK	CU. FT.
<b>Adjustable Dough divider</b>						
SLADD05	5-Wheel	EACH	41.89	1	36	1.75
SLADD06	6-Wheel	EACH	42.99	1	36	2.00
<b>Croissant Cutter</b>						
CRCCT038	Cutter Size: 8 1/4" x 3 3/4" x 3 3/4"	EACH	30.80	1	20	4.40



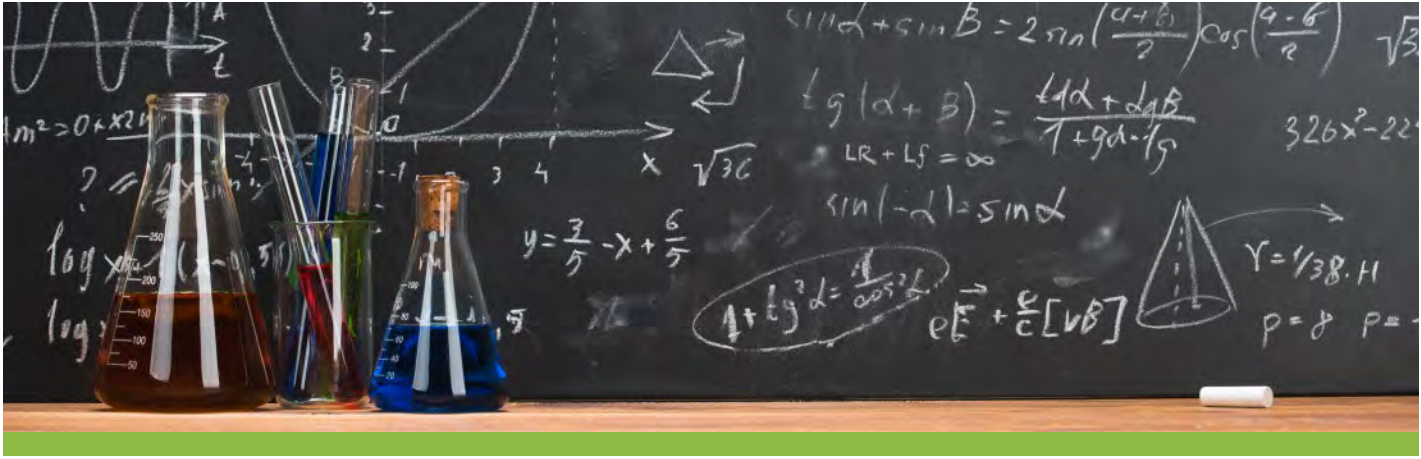

## What is Polycarbonate?

Polycarbonate is a clear, durable, shatterproof material that is known for its impact resistance.

Polycarbonate made materials are far stronger than those made from acrylic. It's used in applications which demand high performance properties such as in bulletproof windows, riot shields, eyewear lenses etc. This thermoplastic polymer has a highly transparency and refractive index and it has better light transmission characteristics than many conventional glasses.

Bring in the polycarbonate material into Foodservice industry, Thunder Group make public of this unique, elegant & stylish line back in 2009, which brings a new twist to professionals in the foodservice industry, flipping the concept of the traditional glassware in commercial environment. Polycarbonate drinkware looks and feels like glass, but, it is not glass. Its usage provides a perfect upscale dining experience while entertaining with friends and family in a safe environment indoor or outdoor. It also adds to the cost-saving in night clubs and bars' operational side in the long run because breakage will never be a concern or turn into a lawsuit for foodservice operators.

### Starburst Pattern

- Crystal clear glass-like
- One-piece molding process
- Durable quality eliminating weak joints
- Shatter and break resistant
- Patented design
- Cold drink (10° C / 50° F) use only





STACKABLE



PLTHRG212C

ROCKS GLASS

ITEM	DESCRIPTION	U/M	WEIGHT GROSS lbs	INNER PACK	MASTER PACK	CU. FT.
PLTHRG208C	8 oz, 3¼"	EACH	6.56	12	24	0.76
PLTHRG210C	10 oz, 3⅝"	EACH	8.34	12	24	0.92
PLTHRG212C	12 oz, 3⅞"	EACH	10.00	12	24	1.12



STACKABLE

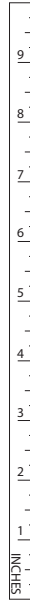

PLTHST214C

HIGHBALL GLASS

ITEM	DESCRIPTION	U/M	WEIGHT GROSS lbs	INNER PACK	MASTER PACK	CU. FT.
PLTHST212C	12 oz, 5⅞"	EACH	10.50	12	24	1.21
PLTHST214C	14 oz, 6⅞"	EACH	12.00	12	24	1.49



PLTHPS013C



PLTHPS023C

PILSNER GLASS

ITEM	DESCRIPTION	U/M	WEIGHT GROSS lbs	INNER PACK	MASTER PACK	CU. FT.
PLTHPS013C	13 oz, 8¼"	EACH	9.90	12	24	1.42
PLTHPS023C	23 oz, 10"	EACH	8.50	12	12	0.81

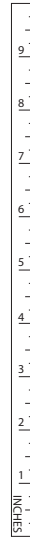

PLPCM001

BEER MUG

ITEM	DESCRIPTION	U/M	WEIGHT GROSS lbs	INNER PACK	MASTER PACK	CU. FT.
PLPCM001	16 oz, 6¼"	EACH	16.32	24	24	1.16

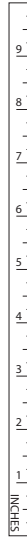

PLTHMG016C

PLTHMG020C

PINT GLASS

ITEM	DESCRIPTION	U/M	WEIGHT GROSS lbs	INNER PACK	MASTER PACK	CU. FT.
PLTHMG016C	16 oz, 6"	EACH	11.46	12	24	1.24
PLTHMG020C	20 oz, 6¾"	EACH	12.41	12	24	1.52

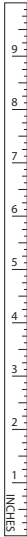

PLTHEP016C

PLTHEP020C

ENGLISH PUB GLASS

ITEM	DESCRIPTION	U/M	WEIGHT GROSS lbs	INNER PACK	MASTER PACK	CU. FT.
PLTHEP016C	16 oz, 6¼"	EACH	10.50	12	24	1.24
PLTHEP020C	20 oz, 6½"	EACH	12.00	12	24	1.49

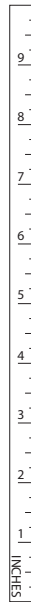

PLTHWP015C

WATER PITCHER w/STARBURST BASE

ITEM	DESCRIPTION	U/M	WEIGHT GROSS lbs	INNER PACK	MASTER PACK	CU. FT.
PLTHWP015C	1.5 liter / 51oz, 9½"	EACH	4.81	1	3	0.86
PLTHWP020C	2 liter / 68oz, 10½"	EACH	6.08	1	3	1.08

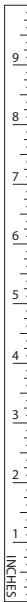

PLWP032CL

WATER PITCHER w/THREE SPOUTS

ITEM	DESCRIPTION	U/M	WEIGHT GROSS lbs	INNER PACK	MASTER PACK	CU. FT.
PLWP032CL	32 oz Water Pitcher (Three Spouts)	EACH	4.81	12	12	0.90
PLWP064CL	64 oz Water Pitcher (Three Spouts)	EACH	9.37	12	12	1.79

Heavy Base Style

STACKABLE PYRAMID



PLTHRG010C

CLASSIC ROCKS GLASS

ITEM	DESCRIPTION	U/M	WEIGHT GROSS lbs	INNER PACK	MASTER PACK	CU. FT.
PLTHRG008C	8½ oz, 3¼"	EACH	8.04	12	24	0.71
PLTHRG010C	10 oz, 3½"	EACH	9.08	12	24	0.78
PLTHRG012C	12 oz, 3¾"	EACH	9.82	12	24	0.85

STACKABLE PYRAMID

Heavy Base Style



PLTHST012C

CLASSIC HIGHBALL

ITEM	DESCRIPTION	U/M	WEIGHT GROSS lbs	INNER PACK	MASTER PACK	CU. FT.
PLTHST012C	12 oz, 5½"	EACH	6.06	12	24	0.86
PLTHST014C	14 oz, 6½"	EACH	6.80	12	24	0.98

Heavy Base Style

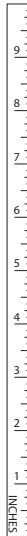

PLTHSG002AC

PLTHSG130SC  
PLTHSG125SC

SHOT GLASS

ITEM	DESCRIPTION	U/M	WEIGHT GROSS lbs	INNER PACK	MASTER PACK	CU. FT.
PLTHSG002AC	2 oz Flair, 3¾"	EACH	20.30	24	144	2.07
PLTHSG125SC	2½ oz Square, 2½"	EACH	17.95	24	144	1.08
PLTHSG130SC	3 oz Square, 2½"	EACH	29.10	24	144	1.35

Heavy Base Style

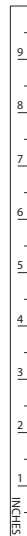

PLTHSG001CC  
PLTHSG015CC  
PLTHSG002CC

SHOT GLASS

ITEM	DESCRIPTION	U/M	WEIGHT GROSS lbs	INNER PACK	MASTER PACK	CU. FT.
PLTHSG001CC	1 oz Round, 2½"	EACH	17.10	24	144	0.89
PLTHSG015CC	1½ oz Round, 3¼"	EACH	21.00	24	144	1.27
PLTHSG002CC	2 oz Round, 4¼"	EACH	23.79	24	144	1.36

Heavy Base Style



PLTHBK140C

ICE BUCKET

ITEM	DESCRIPTION	U/M	WEIGHT GROSS lbs	INNER PACK	MASTER PACK	CU. FT.
PLTHBK040C	4 qt - 8" Diameter, 8 1/2"H	EACH	11.46	1	6	2.38
PLTHBK140C	4 qt - 8" Diameter with 6" Clear PC Tong	EACH	11.84	1	6	2.38

Heavy Base Style



PLTHCG008C

PLTHFT005C

COCKTAIL GLASS / FRUIT TRAY

ITEM	DESCRIPTION	U/M	WEIGHT GROSS lbs	INNER PACK	MASTER PACK	CU. FT.
PLTHCG008C	8 oz, 3 3/4"	EACH	8.27	12	24	0.79
PLTHFT005C	5 oz, 5" Diameter x 2" Tall	EACH	8.51	12	48	1.37



PLTHMR009C

MAGARITA GLASS

ITEM	DESCRIPTION	U/M	WEIGHT GROSS lbs	INNER PACK	MASTER PACK	CU. FT.
PLTHMR009C	9 oz	EACH	7.24	12	12	2.11
PLTHMR009C	11 oz	EACH	8.14	12	12	2.62



PLTHMT008C

MARTINI GLASS

ITEM	DESCRIPTION	U/M	WEIGHT GROSS lbs	INNER PACK	MASTER PACK	CU. FT.
PLTHMT008C	8 oz, 6 1/2"	EACH	8.86	12	24	2.54

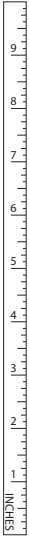

PLTHHC016C PLTHHC024C

**HURICANE GLASSES**

ITEM	DESCRIPTION	U/M	WEIGHT GROSS lbs	INNER PACK	MASTER PACK	CU. FT.
PLTHHC016C	16 oz, 8"	EACH	8.29	12	24	1.54
PLTHHC024C	24 oz, 9 1/4"	EACH	11.77	12	24	2.05

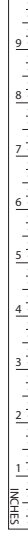

PLTHGL020C

**GOBLET**

ITEM	DESCRIPTION	U/M	WEIGHT GROSS lbs	INNER PACK	MASTER PACK	CU. FT.
PLTHGL020C	20 oz, 7 3/4"	EACH	10.50	12	24	1.59

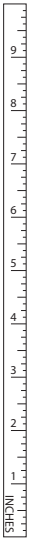

PLTHCP007C



PLTHWG011RC PLTHWG014RC



PLTHWG023RC PLTHWG025RC

**CHAMPAGNE**

ITEM	DESCRIPTION	U/M	WEIGHT GROSS lbs	INNER PACK	MASTER PACK	CU. FT.
PLTHCP007C	7 oz, 9"	EACH	7.14	12	24	1.32

**WINE GLASSES**

ITEM	DESCRIPTION	U/M	WEIGHT GROSS lbs	INNER PACK	MASTER PACK	CU. FT.
PLTHWG011RC	11 oz, 9"	EACH	7.25	12	24	1.42
PLTHWG014RC	14 oz, 9 3/4"	EACH	8.91	12	24	1.83
PLTHWG023RC	23 oz, 9"	EACH	7.94	12	24	2.27
PLTHWG025RC	25 oz, 8 5/8"	EACH	8.38	12	24	2.56

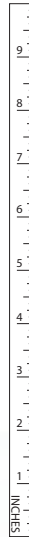

PLTHSS016C

SHOT SHAKER

ITEM	DESCRIPTION	U/M	WEIGHT GROSS lbs	INNER PACK	MASTER PACK	CU. FT.
PLTHSS016C	16 oz - 3 Piece Set, 8¾"	EACH	16.90	6	36	2.23



PLTHCF050CC



PLTHCF100CC



CARAFE

ITEM	DESCRIPTION	U/M	WEIGHT GROSS lbs	INNER PACK	MASTER PACK	CU. FT.
PLTHCF050CC	17 oz Carafe - ½ liter, 6"	EACH	3.55	12	12	0.60
PLTHCF100CC	34 oz Carafe - 1 liter, 9¾"	EACH	5.71	12	12	1.02
PLTHSL001W	Snap Lid (White Polypropylene)	EACH	6.59	12	144	0.62

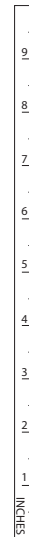

PLTHWD009C

PLTHCF075NC

DECANTER

ITEM	DESCRIPTION	U/M	WEIGHT GROSS lbs	INNER PACK	MASTER PACK	CU. FT.
PLTHWD009C	9 oz, 9¾"	EACH	4.19	12	24	0.71
PLTHCF075NC	750 ml, 9¾"	EACH	6.00	12	12	1.34

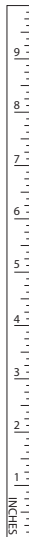

PLTHSN024C

SCHOONER

ITEM	DESCRIPTION	U/M	WEIGHT GROSS lbs	INNER PACK	MASTER PACK	CU. FT.
PLTHSN024C	24 oz Schooner, 7¼"	EACH	11.97	12	12	1.10





# BAR SUPPLIES

2023

## TABLE MOUNT WINE OPENER

This durable mirror polished stainless steel wine opener uses a lever-action mechanism to insert the corkscrew smoothly into the bottle and removes the cork with one quick, upward motion.

ITEM	DESCRIPTION	U/M	WEIGHT GROSS lbs	INNER PACK	MASTER PACK	CU. FT.
SLDWO001	11¾" x 11" x 2" Clamp on max - 1.5" Thick table	EACH	17.64	1	6	1.43



SLDWO001

## BOTTLE AND CAN OPENER

Convenient compact size, for professional bartending. A multi-purpose tool for opening medium size cans and bottle caps.

ITEM	DESCRIPTION	U/M	WEIGHT GROSS lbs	INNER PACK	MASTER PACK	CU. FT.
SLBO002	Flat - 7" x 2"	EACH	49.50	24	240	0.22
SLBO003	Can Opener - 4¼" x ¾" x 1"	EACH	28.66	60	600	0.36
SLBO004	Wall Mount Bottle Opener - 4½" x 2½" x 1"	EACH	49.50	24	288	0.47
SLBO005	Corkscrew Opener, Chrome Plated - 6½" x 2½" x 2½"	EACH	46.30	12	144	3.01
WDW06768	Corkscrew w/ Wooden Handle - 4" x 4" x 1½"	EACH	5.95	24	120	0.64
OW115	Champagne Opener - 7" x 2¾" x 1¾"	EACH	52.80	12	144	1.84
OW110	Rotary Can Opener 8" x 2" x 2½"	EACH	44.53	12	96	1.72
SLBO106	Punch Can Opener 7" x 1¾" x 1"	EACH	38.14	12	144	0.23



SLBO002



SLBO003



SLBO004



SLBO005



WDW06768



OW115



OW110



SLBO106

## CAP CATCHER

Smooth back notch for flat wall-mounting. Deep inner catcher for containing bottle caps.



ITEM	DESCRIPTION	U/M	WEIGHT GROSS lbs	INNER PACK	MASTER PACK	CU. FT.
SLCCA13	5½" x 10"	EACH	43.56	12	24	3.61



SLCCA13

BAR SUPPLIES

209

MRWC001R



MRWC002R

**MARBLE WINE COOLER**

ITEM	DESCRIPTION	U/M	WEIGHT GROSS lbs	INNER PACK	MASTER PACK	CU. FT.
MRWC001R	4 1/2" x 6" Black	EACH	24.20	1	6	0.75
MRWC002R	4 1/2" x 6" Natural	EACH	24.20	1	6	0.75



PLBC004P

**4 COMPARTMENT BAR CADDY WITH COVER**

Sturdy and easy to clean.

ITEM	DESCRIPTION	U/M	WEIGHT GROSS lbs	INNER PACK	MASTER PACK	CU. FT.
PLBC004P	18" x 5" x 3"	EACH	43.25	6	36	5.78



SLCN004

**CONDIMENT COMPARTMENT & REPLACEMENT INSERT**

1-pint plastic inserts. Detachable. Acrylic lid hinged onto stainless steel casing. (Open bottom).

ITEM	DESCRIPTION	U/M	WEIGHT GROSS lbs	INNER PACK	MASTER PACK	CU. FT.
SLCN004	4 Compartments 12" x 5 7/8" x 3 1/2"	EACH	33.10	1	16	3.00
SLCN005	5 Compartments 15" x 5 7/8" x 3 1/2"	EACH	41.50	1	16	3.70
SLCN006	6 Compartments 17 7/8" x 5 7/8" x 3 1/2"	EACH	44.09	1	16	4.50



SLINS002

SLINS001

**Condiment Replacement Inserts, 2 Sizes**

SLINS001	Large, 2 Pint 6" x 5 7/8" x 3"	EACH	14.90	12	60	2.55
SLINS002	Small, 1 Pint 5 3/4" x 3" x 3"	EACH	18.85	12	120	2.41



SSCD004

**CONDIMENT COMPARTMENT**

(Open bottom)



ITEM	DESCRIPTION	U/M	WEIGHT GROSS lbs	INNER PACK	MASTER PACK	CU. FT.
SSCD003	3 Compartments	EACH	37.48	1	16	2.72
SSCD004	4 Compartments	EACH	39.60	1	16	3.56
SSCD005	5 Compartments	EACH	50.60	1	16	4.24
SSCD006	6 Compartments	EACH	57.20	1	16	5.03

**SPEED RAIL**

Organize and store bar pour bottles or other bottles for fast and easy access.



SLSPR022S



ITEM	DESCRIPTION	U/M	WEIGHT GROSS lbs	INNER PACK	MASTER PACK	CU. FT.
SLSPR022S	22" x 4" x 6 1/8"	EACH	28.66	1	8	3.35
SLSPR032S	32" x 4" x 6 1/8"	EACH	30.86	1	6	3.66
SLSPR042S	42" x 4" x 6 1/8"	EACH	24.25	1	4	3.20

SLSPR032S



SLSPR042S

## MUDDLER

Bar muddler with tenderizer head is just the right tool for mashing up fruits, herbs and spices to make those mixed drinks pop. The tenderizer head offers a comprehensive mash.

ITEM	DESCRIPTION	U/M	WEIGHT GROSS lbs	INNER PACK	MASTER PACK	CU. FT.
WDML008W	8" x 1" x 1", Flat Head, Walnut	EACH	23.15	24	144	1.25
PLML008N	8" x 1" x 1", Netted Head, Black	EACH	57.38	12	216	1.75
PLML008T	8" x 1" x 1", Triangular Head, Black	EACH	59.76	12	216	1.83



WDML008W  
Lacquered  
Wood



PLML008N  
Polycarbonate



PLML008T  
Polycarbonate

## DELUXE BAR SPOON

The handle is twirled for easy stirring.



ITEM	DESCRIPTION	U/M	WEIGHT GROSS	INNER PACK	MASTER PACK	CU. FT.
SLKBS011	11" Length	EACH	20.28	24	240	0.49



SLKBS011

## BAR TONG

Hang tag packaging.



ITEM	DESCRIPTION	U/M	WEIGHT GROSS lbs	INNER PACK	MASTER PACK	CU. FT.
IRSH4403	4 3/4" Multi-Functional Tongs	EACH	24.26	12	360	1.80
SLGB026	9 7/8" Bean Tongs	EACH	40.13	12	360	3.00
SLPB030	12" Plum Tongs	EACH	40.13	12	360	3.48

IRSH4403



SLGB026

SLPB030

## STRAINER



ITEM	DESCRIPTION	U/M	WEIGHT GROSS lbs	INNER PACK	MASTER PACK	CU. FT.
SLBS022	Bar Strainer 6" x 4 5/8" x 7/8"	EACH	14.33	24	120	1.22
SLJS031	Julep Strainer 6 1/8" x 2 7/8" x 1 1/2"	EACH	23.75	12	240	0.76



SLBS022



SLJS031



SLHO030

**SCOOP**



ITEM	DESCRIPTION	U/M	WEIGHT GROSS lbs	INNER PACK	MASTER PACK	CU. FT.
SLHO030	4 oz - 9 3/4" x 3 5/8" x 1"	EACH	24.64	12	144	1.22



IRCP008

IRPC008

**ICE CHIPPER & ICE PICK**

Comes with comfortable wooden handle.

ITEM	DESCRIPTION	U/M	WEIGHT GROSS lbs	INNER PACK	MASTER PACK	CU. FT.
IRCP008	9" Chipper - 9" x 2 7/16" x 9/2"	EACH	40.79	12	120	1.32
IRPC008	8" Pick - 8" x 1 3/16" x 1 1/16"	EACH	30.36	12	180	3.81

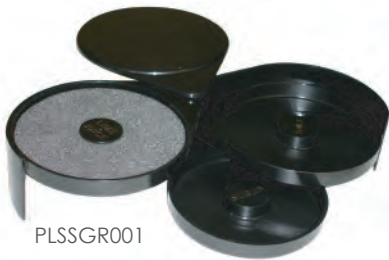

PLSSGR001

**SALT & SUGAR GLASS RIMMER**

Folds to small package for easy storage. Accommodates cocktail glasses up to 5 1/2 in diameter.

ITEM	DESCRIPTION	U/M	WEIGHT GROSS lbs	INNER PACK	MASTER PACK	CU. FT.
PLSSGR001	Three swing trays with a sponge for dampening the glass rim	EACH	25.96	2	24	1.96



PLBC006

**BAR CADDY**



ITEM	DESCRIPTION	U/M	WEIGHT GROSS lbs	INNER PACK	MASTER PACK	CU. FT.
PLBC006	Plastic Bar Caddy 6 Compartments 9 1/2" x 5 3/4" x 4 1/8"	EACH	15.19	1	12	1.92



PLTP050A Arrow

PLTP050S Sword

**PICKS**

Assorted colors. (500 piece per pack)



ITEM	DESCRIPTION	U/M	WEIGHT GROSS	INNER PACK	MASTER PACK	CU. FT.
PLTP050A	3 1/2" Arrow	PACK	23.15	24	96	2.85
PLTP050S	3" Sword	PACK	35.27	12	96	6.11

## COCKTAIL SHAKER

Versatile functions for both dry and wet products.



ITEM	DESCRIPTION	U/M	WEIGHT GROSS lbs	INNER PACK	MASTER PACK	CU. FT.
SLIG001	15 oz - 3 5/8" x 3 5/8" x 4 5/8"	EACH	49.94	12	144	1.08
SLIG002	30 oz - 3 5/8" x 3 5/8" x 7"	EACH	36.00	6	72	1.37



SLIG001



SLIG002

## COCKTAIL SHAKER SET

Mirror-finished stainless steel mixer. Three-piece ensemble: container, cup and ice strainer for spill-free pouring.



ITEM	DESCRIPTION	U/M	WEIGHT GROSS lbs	INNER PACK	MASTER PACK	CU. FT.
SLIG008	8 oz - 3 Piece Set 2 3/4" x 2 3/4" x 7 1/8"	EACH	19.84	1	48	2.40
SLIG003	16 oz - 3 Piece Set 3" x 3" x 7 5/8"	EACH	14.40	1	24	1.42
SLIG004	28 oz - 3 Piece Set 3 5/8" x 3 5/8" x 10"	EACH	16.94	1	24	2.84



SLIG008

SLIG003

SLIG004

## MALT CUP

Fits standard machines.



ITEM	DESCRIPTION	U/M	WEIGHT GROSS lbs	INNER PACK	MASTER PACK	CU. FT.
SLMC001	30 oz 4 1/8" x 4 1/8" x 6 3/4"	EACH	34.87	6	72	1.49



SLMC001

## JIGGER

Holds from 1/2 oz to 2 oz.



ITEM	DESCRIPTION	U/M	WEIGHT GROSS lbs	INNER PACK	MASTER PACK	CU. FT.
SLJG001	1/2 & 1 oz 2" x 2" x 2 3/16"	EACH	24.25	12	300	1.96
SLJG002	3/4 & 1 1/2 oz 1 7/8" x 2 5/16" x 2 11/16"	EACH	31.80	12	300	3.53
SLJG003	1 & 2 oz 2 5/8" x 2 5/8" x 3 1/8"	EACH	37.70	12	300	4.68



SLJG001



SLJG002



SLJG003

**INTERLOCKING MAT**

ITEM	DESCRIPTION	U/M	WEIGHT GROSS lbs	INNER PACK	MASTER PACK	CU. FT.
PLIM1212SM	12" x 12" Black	EACH	11.44	1	12	0.69

- Light weight
- Dishwasher safe
- Sanitary
- Durable
- Easy assembly

PLIM1212SM



Bar mat securely interlocks via underside tab. Mat can be easily put together and taken apart to fit desired area.

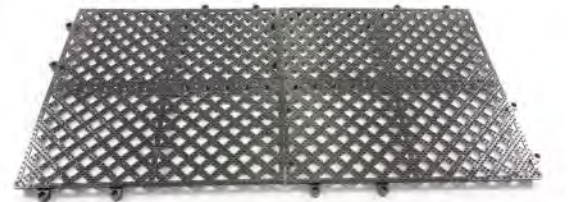

Two interlocked bar mats.

**BAR SERVICE MAT**

The non-slip drainer/mats are essential to keep counter tops clean. Pattern molds helps to secure grip for wet glassware, and the receptacle ends provides drainage for spilled drinks. Easy to wash. Available in brown or black.

ITEM	DESCRIPTION	U/M	WEIGHT GROSS lbs	INNER PACK	MASTER PACK	CU. FT.
<b>Service Mat</b>						
PLSVM1218BL	12" x 18" Black	EACH	26.23	1	12	0.71
PLSVM1218R	12" x 18" Brown	EACH	26.23	1	12	0.71
<b>Bar Mat</b>						
PLBM027BL	27" x 3 1/4" Black	EACH	48.50	1	50	1.98
PLBM027R	27" x 3 1/4" Brown	EACH	48.50	1	50	1.98

**SERVICE MAT**



PLSVM1218BL

PLSVM1218R

**BAR MAT**

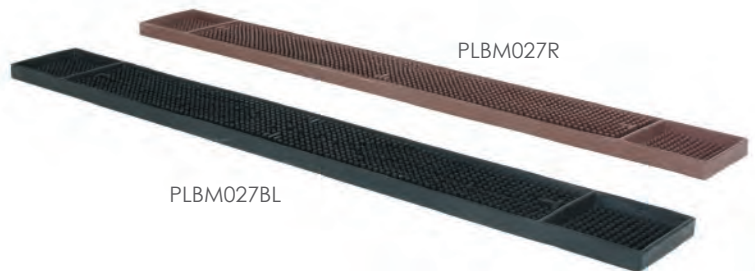

PLBM027R

PLBM027BL

**BAR LINER**

Bar liners provides impact absorption and drainage.

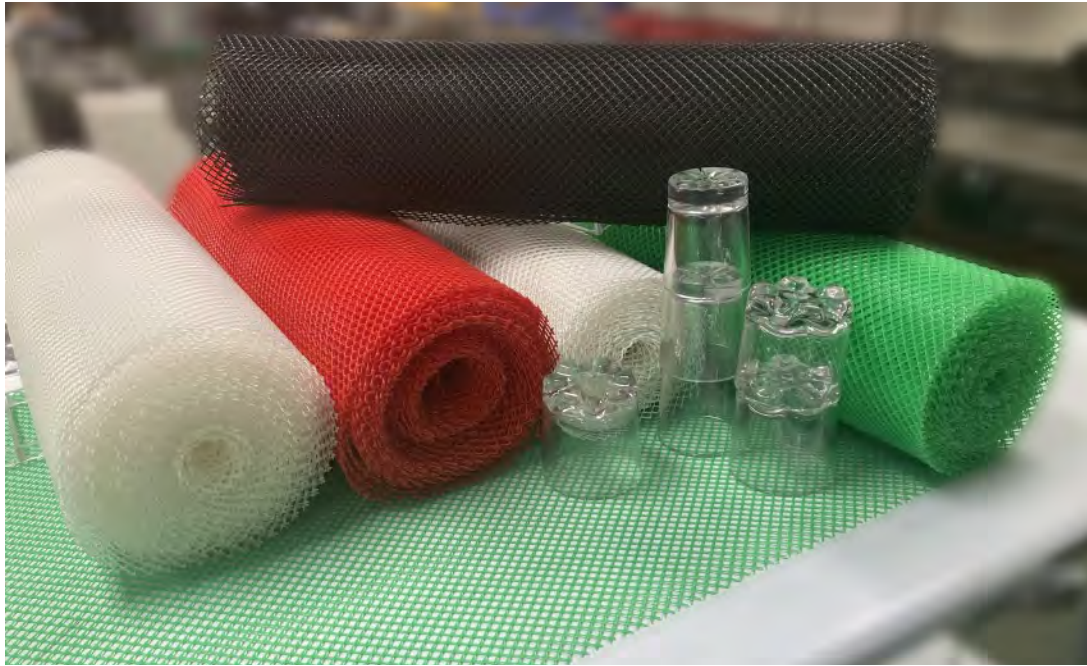

ITEM	DESCRIPTION	U/M	WEIGHT GROSS lbs	INNER PACK	MASTER PACK	CU. FT.
PLBL240C	2' x 40' Clear	EACH	13.23	1	2	2.02
PLBL240G	2' x 40' Green	EACH	13.23	1	2	2.02
PLBL240K	2' x 40' Black	EACH	13.23	1	2	2.02
PLBL240R	2' x 40' Red	EACH	13.23	1	2	2.02
PLBL240W	2' x 40' White	EACH	13.23	1	2	2.02

**WIRE GLASS HANGER**

Stores glass stemware.

ITEM	DESCRIPTION	U/M	WEIGHT GROSS lbs	INNER PACK	MASTER PACK	CU. FT.
<b>Brass Plated</b>						
SLKGH010	10" x 4 <sup>9</sup> / <sub>16</sub> " x 1 <sup>5</sup> / <sub>8</sub> "	EACH	41.01	12	120	2.54
SLKGH016	16" x 4 <sup>9</sup> / <sub>16</sub> " x 1 <sup>5</sup> / <sub>8</sub> "	EACH	28.00	12	60	2.09
SLKGH024	24" x 4 <sup>9</sup> / <sub>16</sub> " x 1 <sup>5</sup> / <sub>8</sub> "	EACH	37.04	12	60	3.11
<b>Chrome Plated</b>						
SLKGH010C	10" x 4 <sup>9</sup> / <sub>16</sub> " x 1 <sup>5</sup> / <sub>8</sub> "	EACH	41.01	12	120	2.54
SLKGH016C	16" x 4 <sup>9</sup> / <sub>16</sub> " x 1 <sup>5</sup> / <sub>8</sub> "	EACH	28.00	12	60	2.09
SLKGH024C	24" x 4 <sup>9</sup> / <sub>16</sub> " x 1 <sup>5</sup> / <sub>8</sub> "	EACH	37.04	12	60	3.11

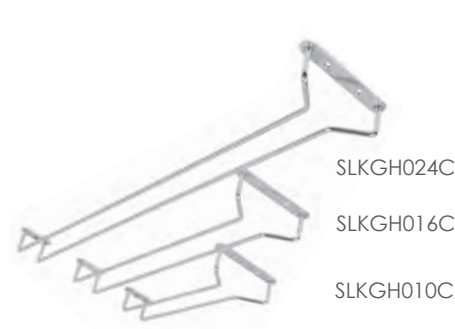

LIQUOR & JUICE POUR BOTTLES



PLSNP01B



PLSNP01G



PLSNP01O



PLSNP01R



PLSNP01W



PLSNP01Y

1 QT

Color Coded

ITEM	DESCRIPTION	U/M	WEIGHT GROSS lbs	INNER PACK	MASTER PACK	CU. FT.
PLSNP01B	1 qt Brown - 3¾" x 3¾" x 13½"	EACH	5.84	1	12	0.85
PLSNP01G	1 qt Green - 3¾" x 3¾" x 13½"	EACH	5.84	1	12	0.85
PLSNP01O	1 qt Orange - 3¾" x 3¾" x 13½"	EACH	5.84	1	12	0.85
PLSNP01R	1 qt Red - 3¾" x 3¾" x 13½"	EACH	5.84	1	12	0.85
PLSNP01W	1 qt White - 3¾" x 3¾" x 13½"	EACH	5.84	1	12	0.85
PLSNP01Y	1 qt Yellow - 3¾" x 3¾" x 13½"	EACH	5.84	1	12	0.85



PLSNP02B



PLSNP02G



PLSNP02O



PLSNP02R



PLSNP02W



PLSNP02Y

2 QT

Color Coded

ITEM	DESCRIPTION	U/M	WEIGHT GROSS lbs	INNER PACK	MASTER PACK	CU. FT.
PLSNP02B	2 qt Brown - 4½" x 4½" x 13¾"	EACH	3.28	1	6	0.87
PLSNP02G	2 qt Green - 4½" x 4½" x 13¾"	EACH	3.28	1	6	0.87
PLSNP02O	2 qt Orange - 4½" x 4½" x 13¾"	EACH	3.28	1	6	0.87
PLSNP02R	2 qt Red - 4½" x 4½" x 13¾"	EACH	3.28	1	6	0.87
PLSNP02W	2 qt White - 4½" x 4½" x 13¾"	EACH	3.28	1	6	0.87
PLSNP02Y	2 qt Yellow - 4½" x 4½" x 13¾"	EACH	3.28	1	6	0.87





**POURER**

Economy free flow pourer with wide range of selection on flow speeds.

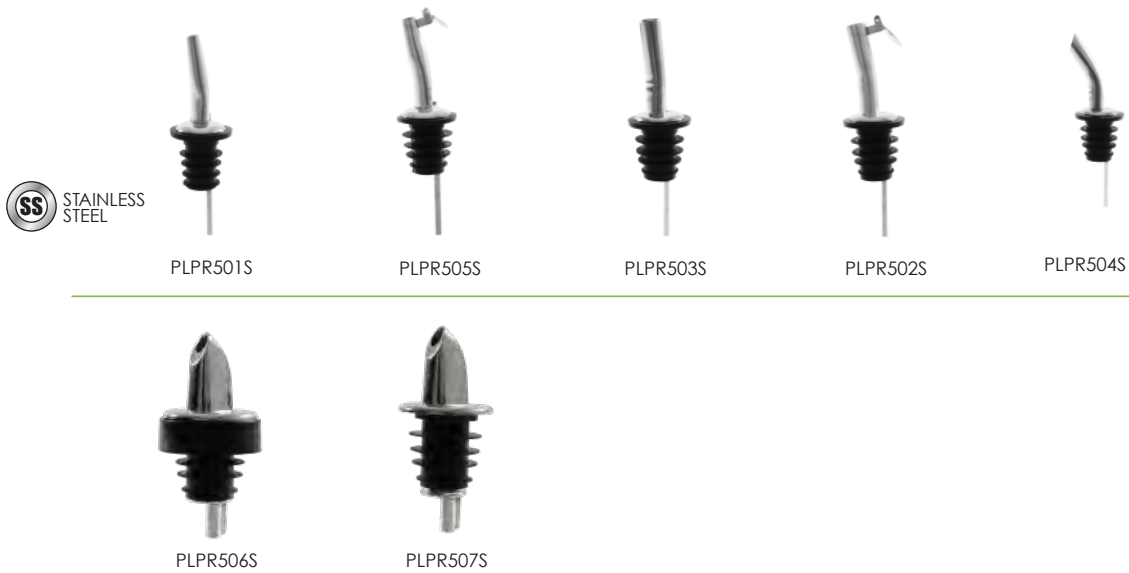

ITEM	DESCRIPTION	U/M	WEIGHT GROSS lbs	INNER PACK	MASTER PACK	CU. FT.
<b>Stainless Steel</b>						
PLPR501S	Tapered, Med Flow - 4½" x 1½" x 1½"	PACK OF 12	17.60	12	48	2.88
PLPR505S	Tapered with Flip Cap, Med Flow - 4½" x 1½" x 1½"	PACK OF 12	23.54	12	48	2.88
PLPR503S	Jet, Extra Fast Flow - 4½" x 1½" x 1½"	PACK OF 12	17.97	12	48	2.88
PLPR502S	Jet with Flip Cap, Fast Flow - 4½" x 1½" x 1½"	PACK OF 12	19.49	12	48	2.88
PLPR504S	Gooseneck, Fast Flow - 4½" x 1½" x 1½"	PACK OF 12	18.35	12	48	2.88
<b>Chrome</b>						
PLPR506S	Free Flow. Soft Collar	PACK OF 12	23.23	12	72	2.24
PLPR507S	Free Flow. No Collar	PACK OF 12	18.68	12	72	2.24

**POURER COVER**



PLPRC001

**UNIVERSAL CAP**

**DUST CAP**



PLPRC002BK



PLPRC002RD

ITEM	DESCRIPTION	U/M	WEIGHT GROSS lbs	INNER PACK	MASTER PACK	CU. FT.
PLPRC001	Universal Cap, Plastic - 3" x 1½" x 1½"	PACK OF 12	25.45	12	48	2.88
PLPRC002BK	Dust Cap, 1", Black, Plastic - ½" x ½" x ⅝"	PACK OF 12	10.12	1	144	0.98
PLPRC002RD	Dust Cap, 1", Red, Plastic	PACK OF 12	10.12	1	144	0.98

**MEASURED POURER**

Fits standard 750 mL liquor bottles and color coded for portion control.

**Collared**



Color Coded

ITEM	DESCRIPTION	U/M	WEIGHT GROSS lbs	INNER PACK	MASTER PACK	CU. FT.
PLPR050C	½ oz, Orange Tail	PACK OF 12	16.02	1	25	1.19
PLPR063C	⅝ oz, Black Tail	PACK OF 12	16.02	1	25	1.19
PLPR075C	¾ oz, Green Tail	PACK OF 12	16.02	1	25	1.19
PLPR088C	⅞ oz, Blue Tail	PACK OF 12	16.02	1	25	1.19
PLPR100C	1 oz, Red Tail	PACK OF 12	16.02	1	25	1.19
PLPR113C	1 ⅙ oz, Purple Tail	PACK OF 12	16.02	1	25	1.19
PLPR125C	1 ¼ oz, Clear Tail	PACK OF 12	16.02	1	25	1.19
PLPR150C	1 ½ oz, Yellow Tail	PACK OF 12	16.02	1	25	1.19
PLPR200C	2 oz, White Tail	PACK OF 12	16.02	1	25	1.19

Package of 12



**Without Collar**

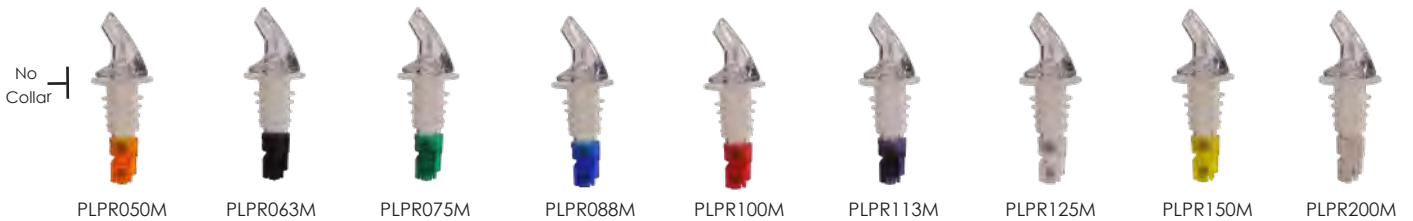

Color Coded

ITEM	DESCRIPTION	U/M	WEIGHT GROSS lbs	INNER PACK	MASTER PACK	CU. FT.
PLPR050M	½ oz, Orange Tail	PACK OF 12	12.72	1	25	1.19
PLPR063M	⅝ oz, Black Tail	PACK OF 12	12.72	1	25	1.19
PLPR075M	¾ oz, Green Tail	PACK OF 12	12.72	1	25	1.19
PLPR088M	⅞ oz, Blue Tail	PACK OF 12	12.72	1	25	1.19
PLPR100M	1 oz, Red Tail	PACK OF 12	12.72	1	25	1.19
PLPR113M	1 ⅙ oz, Purple Tail	PACK OF 12	12.72	1	25	1.19
PLPR125M	1 ¼ oz, Clear Tail	PACK OF 12	12.72	1	25	1.19
PLPR150M	1 ½ oz, Yellow Tail	PACK OF 12	12.72	1	25	1.19
PLPR200M	2 oz, White Tail	PACK OF 12	12.72	1	25	1.19

Package of 12



## SCREENED POURER

The build-in screen will keep bugs and insects from entering the bottle.



Color Coded

ITEM	DESCRIPTION	U/M	WEIGHT GROSS lbs	INNER PACK	MASTER PACK	CU. FT.
PLPR600AM	Amber - 3½" x 1⅜" x 1⅜"	PACK OF 12	15.44	12	48	2.88
PLPR600CL	Clear - 3½" x 1⅜" x 1⅜"	PACK OF 12	15.44	12	48	2.88
PLPR600RD	Red - 3½" x 1⅜" x 1⅜"	PACK OF 12	15.44	12	48	2.88
PLPR600SM	Smoke - 3½" x 1⅜" x 1⅜"	PACK OF 12	15.44	12	48	2.88

## FLOW LIQUOR POURER

### Collared



With Collar

### Without Collar

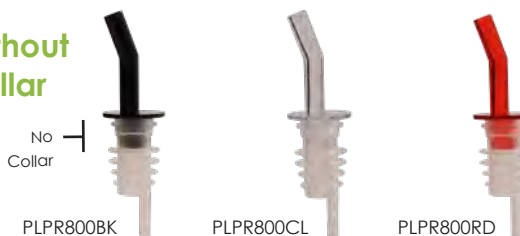

No Collar

ITEM	DESCRIPTION	U/M	WEIGHT GROSS lbs	INNER PACK	MASTER PACK	CU. FT.
PLPR700BK	Black - 4½" x 1½" x 1½"	PACK OF 12	18.37	12	48	2.88
PLPR700CL	Clear - 4½" x 1½" x 1½"	PACK OF 12	18.37	12	48	2.88
PLPR700RD	Red - 4½" x 1½" x 1½"	PACK OF 12	18.37	12	48	2.88
PLPR800BK	Black - 3½" x 1½" x 1½"	PACK OF 12	12.28	12	48	2.88
PLPR800CL	Clear - 3½" x 1½" x 1½"	PACK OF 12	12.28	12	48	2.88
PLPR800RD	Red - 3½" x 1½" x 1½"	PACK OF 12	12.28	12	48	2.88

## FREE FLOW POURER



Color Coded

ITEM	DESCRIPTION	U/M	WEIGHT GROSS lbs	INNER PACK	MASTER PACK	CU. FT.
PLPR900BK	Black - 2⅔" x 1⅜" x 1⅜"	PACK OF 12	13.90	12	72	2.24
PLPR900BL	Blue - 2⅔" x 1⅜" x 1⅜"	PACK OF 12	13.90	12	72	2.24
PLPR900CL	Clear - 2⅔" x 1⅜" x 1⅜"	PACK OF 12	13.90	12	72	2.24
PLPR900GR	Green - 2⅔" x 1⅜" x 1⅜"	PACK OF 12	13.90	12	72	2.24
PLPR900RD	Red - 2⅔" x 1⅜" x 1⅜"	PACK OF 12	13.90	12	72	2.24
PLPR900WH	White - 2⅔" x 1⅜" x 1⅜"	PACK OF 12	13.90	12	72	2.24
PLPR900YW	Yellow - 2⅔" x 1⅜" x 1⅜"	PACK OF 12	13.90	12	72	2.24

**SLIP RESISTANT SERVING TRAY**

Anti-slip serving trays with textured surface or cork.

**ABS**

	ITEM	DESCRIPTION	U/M	WEIGHT GROSS lbs	INNER PACK	MASTER PACK	CU. FT.
Textured Surface	PLRT012	12" Round, (S), <b>Black</b>	EACH	42.99	12	60	1.95
	PLRT014	14" Round, (M), <b>Black</b>	EACH	55.12	12	48	2.00
	PLRT016	16" Round, (L), <b>Black</b>	EACH	70.55	12	48	2.55
	PLRT1612	16" x 12 Rectangular, <b>Black</b>	EACH	42.99	12	36	2.42
Cork	PLRT012BCK	12" Round w/ Cork, (S), <b>Black</b>	EACH	45.10	12	60	1.95
	PLRT014BCK	14" Round w/ Cork, (M), <b>Black</b>	EACH	48.38	12	48	2.00
	PLRT016BCK	16" Round w/ Cork, (L), <b>Black</b>	EACH	61.71	12	48	2.55
	PLRT1612BCK	16" x 12 Rectangular w/ Cork, <b>Black</b>	EACH	44.35	12	36	2.42
	PLRT012CK	12" Round w/ Cork, (S), <b>Brown</b>	EACH	45.19	12	60	1.95
	PLRT014CK	14" Round w/ Cork, (M), <b>Brown</b>	EACH	48.48	12	48	2.00
	PLRT016CK	16" Round w/ Cork, (L), <b>Brown</b>	EACH	61.84	12	48	2.55
	PLRT1612CK	16" x 12 Rectangular w/ Cork, <b>Brown</b>	EACH	44.44	12	36	2.42



**POLYPROPYLENE**

	ITEM	DESCRIPTION	U/M	WEIGHT GROSS lbs	INNER PACK	MASTER PACK	CU. FT.
Black	PLST1100BL	11" Round Tray	EACH	10.36	12	12	0.31
	PLST1400BL	14" Round Tray	EACH	14.11	12	12	0.49
	PLST1600BL	16" Round Tray	EACH	25.35	12	12	0.72
	PLST1418BL	14" x 18" Rectangular Tray	EACH	22.48	12	12	0.75
	PLST2700BL	22" x 27" Oval Tray	EACH	35.26	6	6	1.89
Brown	PLST1100BR	11" Round Tray	EACH	10.36	12	12	0.31
	PLST1400BR	14" Round Tray	EACH	14.11	12	12	0.49
	PLST1600BR	16" Round Tray	EACH	25.35	12	12	0.72
	PLST1418BR	14" x 18" Rectangular Tray	EACH	22.48	12	12	0.75
	PLST2700BR	22" x 27" Oval Tray	EACH	35.26	6	6	1.89

Round Tray  
PLST1100 ~ PLST1600



PLST1418



PLST2700



**FIBERGLASS**

	ITEM	DESCRIPTION	U/M	WEIGHT GROSS lbs	INNER PACK	MASTER PACK	CU. FT.
<b>Black</b>	PLFT1100BK	11" Round	EACH	10.14	1	12	0.34
	PLFT1400BK	14" Round	EACH	16.09	1	12	0.52
	PLFT1418BK	14" x 18" Rectangular	EACH	28.66	1	12	0.77
	PLFT1600BK	16" Round	EACH	25.35	1	12	0.72
	PLFT2700BK	22" x 27" Oval	EACH	27.78	1	6	1.91
<b>Brown</b>	PLFT1100BR	11" Round	EACH	10.14	1	12	0.34
	PLFT1400BR	14" Round	EACH	16.09	1	12	0.52
	PLFT1418BR	14" x 18" Rectangular	EACH	28.66	1	12	0.77
	PLFT1600BR	16" Round	EACH	25.35	1	12	0.72
	PLFT2700BR	22" x 27" Oval	EACH	27.78	1	6	1.91

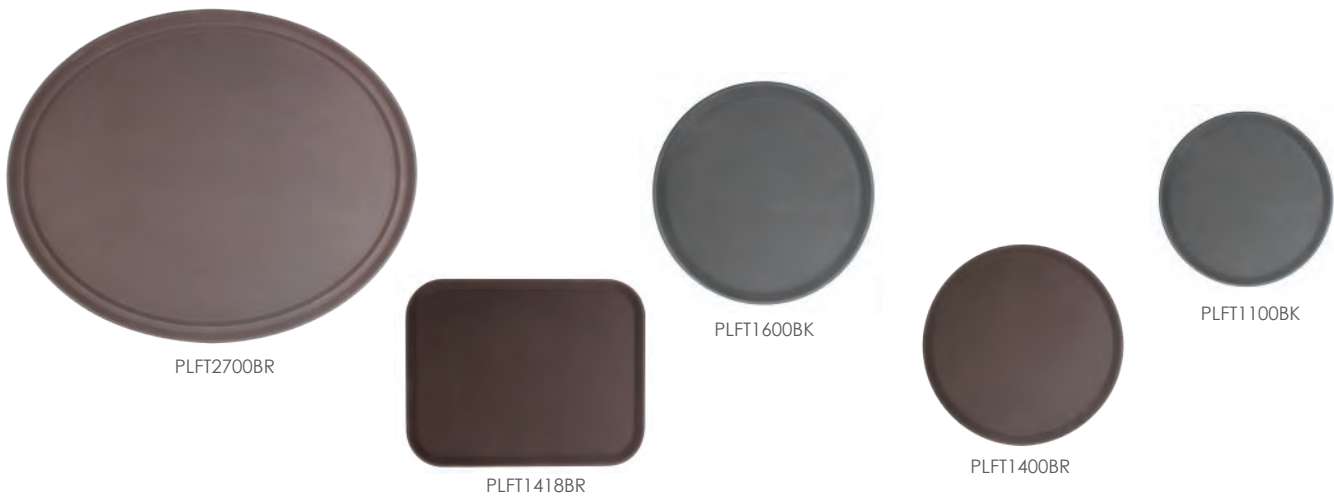

**WINE BUCKET & FOLDABLE STAND**

Present chilled wines and champagnes in an elegant ensemble.



ITEM	DESCRIPTION	U/M	WEIGHT GROSS lbs	INNER PACK	MASTER PACK	CU. FT.
SLWB001	8 qt Wine Bucket 10" x 9" x 10 1/8"	EACH	44.85	6	24	3.45
SLWB003	Foldable Stand 9 3/4" x 9 3/4" x 28 5/8"	EACH	36.30	3	12	1.23

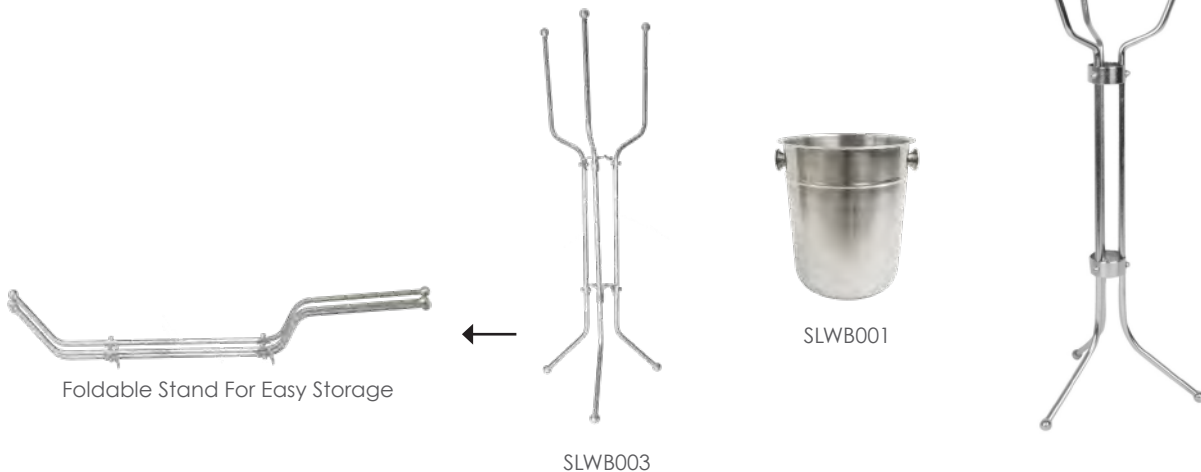

# CATERING & BUFFETWARE



CATERING & BUFFETWARE



SLRCF0860

## ROUND ROLL TOP CHAFER

Swivels open easily to 90 degree angle.



ITEM	DESCRIPTION	U/M	WEIGHT GROSS lbs	INNER PACK	MASTER PACK	CU. FT.
SLRCF0860	6 qt with Stainless Steel Handle 17" x 16½" x 17¾"	SET	24.25	1	1	3.28



SLRCF8632

## DELUXE ROUND CHAFER

Stainless steel Deluxe Round Chafers with faux wood or brass handles and knobs with a polished finish cover. Serves up to 5 quarts.



ITEM	DESCRIPTION	U/M	WEIGHT GROSS lbs	INNER PACK	MASTER PACK	CU. FT.
SLRCF8632	5 qt with Wood Handle 17¾" x 13" x 16½"	SET	9.50	1	1	2.36
SLRCF8633	5 qt with Brass Handle 17¾" x 13" x 16½"	SET	10.50	1	1	2.36



SLRCF8633



SLRCF8633



SLRCF8307

## MARMITE CHAFER



ITEM	DESCRIPTION	U/M	WEIGHT GROSS lbs	INNER PACK	MASTER PACK	CU. FT.
SLRCF8307	7 qt 12½" x 9¼" x 13¼"	EACH	6.83	1	1	0.81
SLRCF8311	11 qt 14½" x 11½" x 13¼"	EACH	7.94	1	1	1.08



SLRCF8311



SLRCF8307

## DELUXE CHAFER - HALF SIZE



ITEM	DESCRIPTION	U/M	WEIGHT GROSS lbs	INNER PACK	MASTER PACK	CU. FT.
SLRCF0825	4 qt with Faux Wood Handle 17 <sup>1</sup> / <sub>16</sub> " x 11 <sup>1</sup> / <sub>16</sub> " x 16 <sup>3</sup> / <sub>16</sub> "	SET	9.76	1	1	1.42



SLRCF0825

## DELUXE CHAFER - FULL SIZE

Full size Deluxe Chafers. Handles also available in faux wood or brass.



ITEM	DESCRIPTION	U/M	WEIGHT GROSS lbs	INNER PACK	MASTER PACK	CU. FT.
SLRCF8532	8 qt with Faux Wood Handle 26 <sup>1</sup> / <sub>2</sub> " x 14" x 16 <sup>1</sup> / <sub>2</sub> "	SET	17.00	1	1	2.84
SLRCF8533	8 qt with Brass Handle 26 <sup>1</sup> / <sub>2</sub> " x 14" x 16 <sup>1</sup> / <sub>2</sub> "	SET	16.42	1	1	2.84



SLRCF8532



SLRCF8533



SLRCF8532

## CONTINENTAL CHAFER



ITEM	DESCRIPTION	U/M	WEIGHT GROSS lbs	INNER PACK	MASTER PACK	CU. FT.
SLRCF0840	8 qt with Brass Handle 22 <sup>3</sup> / <sub>8</sub> " x 14 <sup>7</sup> / <sub>8</sub> " x 12 <sup>3</sup> / <sub>4</sub> "	SET	13.23	1	1	2.03



SLRCF0840

## WIRE STAND

ITEM	DESCRIPTION	U/M	WEIGHT GROSS lbs	INNER PACK	MASTER PACK	CU. FT.
SLRCF511	22 <sup>3</sup> / <sub>4</sub> " x 12 <sup>1</sup> / <sub>4</sub> " x 9" Wire Stand for Full Size Aluminum Foil Tray	EACH	17.64	1	10	3.42



SLRCF511

**GOLD ACCENTED ROUND CHAFER**



ITEM	DESCRIPTION	U/M	WEIGHT GROSS lbs	INNER PACK	MASTER PACK	CU. FT.
SLRCF0831GH	4 qt - 16½" x 13¾" x 12"	SET	8.50	1	1	1.14



SLRCF0831GH



Gift boxed

**GOLD ACCENTED OVAL CHAFER**



ITEM	DESCRIPTION	U/M	WEIGHT GROSS lbs	INNER PACK	MASTER PACK	CU. FT.
SLRCF0836GH	6 qt - 21¾" x 12¾" x 11½"	SET	10.58	1	1	1.93



SLRCF0836GH



Gift boxed

**GOLD ACCENTED OBLONG CHAFER**



ITEM	DESCRIPTION	U/M	WEIGHT GROSS lbs	INNER PACK	MASTER PACK	CU. FT.
SLRCF0833GH	8 qt - 25" x 13¾" x 12¼"	SET	13.23	1	1	2.07



SLRCF0833GH



Gift boxed



**GOLD ACCENTED CHAFER**



ITEM	DESCRIPTION	U/M	WEIGHT GROSS lbs	INNER PACK	MASTER PACK	CU. FT.
SLRCF0834GH	4 qt - 17" x 11½" x 12½"	SET	8.38	1	1	1.25



Gift boxed



SLRCF0834GH

**STACKABLE CHAFER**



ITEM	DESCRIPTION	U/M	WEIGHT GROSS lbs	INNER PACK	MASTER PACK	CU. FT.
SLRCF0833BT	8 qt - 24¾" x 14¾" x 12¾"	SET	13.67	1	1	2.07



Gift boxed



SLRCF0833BT

**ROLL TOP CHAFER**

Roll top golden chafer with gold accents on handles. Fuel holders side in underneath. 8 quart capacity.



ITEM	DESCRIPTION	U/M	WEIGHT GROSS lbs	INNER PACK	MASTER PACK	CU. FT.
SLRCF0171G	8 qt, with Golden Accent Handles 24¼" x 14¾" x 15½"	SET	24.47	1	1	3.27



Gift boxed



SLRCF0171G

## ECONOMY CHAFER

Parts & accessories sold separately.



ITEM	DESCRIPTION	U/M	WEIGHT GROSS lbs	INNER PACK	MASTER PACK	CU. FT.
SLRCF001F	8 qt - 23 $\frac{3}{8}$ " x 13 $\frac{3}{8}$ " x 12 $\frac{3}{8}$ ", w/ Folding Stand	SET	11.01	1	1	1.15
SLRCF001	8 qt - 23 $\frac{3}{8}$ " x 13 $\frac{3}{8}$ " x 15 $\frac{1}{2}$ ", w/ Plastic Handle on Top Cover	SET	12.79	1	1	2.13
SLRCF002	8 qt - 23 $\frac{3}{8}$ " x 13 $\frac{3}{8}$ " x 13 $\frac{3}{8}$ " Plastic Footed	SET	13.23	1	1	2.17
SLRCF005	8 qt - 22 $\frac{5}{8}$ " x 14 $\frac{7}{8}$ " x 12 $\frac{3}{4}$ " Foldable	SET	13.67	1	1	1.29



SLRCF001F



Foldable Stand



Gift Boxed



SLRCF001



Gift boxed



SLRCF002



Gift boxed



Holder clips for cover included



SLRCF005



Gift boxed

### CHAFFER PARTS & ACCESSORIES

ITEM	DESCRIPTION	U/M	WEIGHT GROSS lbs	INNER PACK	MASTER PACK	CU. FT.
SLRCF100	Cover Holder Clip 5 <sup>9</sup> / <sub>8</sub> " x 1" x 1"	EACH	3.09	12	12	0.70
SLRCF111	Dripless Water Pan 22" x 14" x 4 <sup>1</sup> / <sub>2</sub> "	EACH	40.78	1	12	2.52
SLRCF112	Dome Cover with Plastic Handle 21 <sup>1</sup> / <sub>8</sub> " x 13 <sup>1</sup> / <sub>8</sub> " x 4"	EACH	26.23	1	12	3.18
SLRCF113	Fuel Holder 6 <sup>3</sup> / <sub>8</sub> " x 3 <sup>1</sup> / <sub>2</sub> " x 2 <sup>5</sup> / <sub>8</sub> "	EACH	28.00	6	72	2.30
SLRCF114	Folding Frame with Fuel Plate 23" x 12 <sup>1</sup> / <sub>2</sub> " x 9"	SET	5.51	1	1	1.06
SLRCF115	Dome Cover With Chrome Plated Handle 21 <sup>1</sup> / <sub>8</sub> " x 13" x 3 <sup>1</sup> / <sub>3</sub> "	EACH	26.23	12	24	3.01



SLRCF112



SLRCF115



SLRCF100



SLRCF111



SLRCF114



SLRCF113



SLRCF114  
Shown folded

### HINGED DOME COVER

Hinged dome cover with handle, suitable for full size (8 qt) chafers.

ITEM	DESCRIPTION	U/M	WEIGHT GROSS lbs	INNER PACK	MASTER PACK	CU. FT.
SLRCF7100	Stainless Steel 21 <sup>3</sup> / <sub>8</sub> " x 12" x 2 <sup>1</sup> / <sub>2</sub> "	EACH	41.89	3	12	5.00
PLRCF001H	Polycarbonate 21" x 13" x 3"	EACH	23.25	12	12	2.98
PLRCF001R	Roll Top Chafer Cover, Polycarbonate 21 <sup>1</sup> / <sub>8</sub> " x 14 <sup>1</sup> / <sub>4</sub> " x 7 <sup>1</sup> / <sub>3</sub> "	EACH	9.59	4	4	3.45



SLRCF7100



PLRCF001R



PLRCF001H



PLRCF001H

18/8 STAINLESS STEEL LUXOR SPOON

High quality serving spoons are elegantly crafted in 18-8 stainless steel in mirror finish.



ITEM	DESCRIPTION	U/M	WEIGHT GROSS lbs	INNER PACK	MASTER PACK	CU. FT.
<b>Spoon</b>						
SLBF101	13" Solid - 3 3/4" x 2 1/2 x 1 5/8", 9 3/4" Handle Length	EACH	49.70	12	120	0.56
SLBF102	13" Slotted 3 3/4" x 2 1/2 x 1 5/8", 9 3/4" Handle Length	EACH	45.40	12	120	0.56
SLBF103	10 1/2" Solid 3 3/4" x 2 1/2 x 1 5/8", 7 1/8" Handle Length	EACH	41.00	12	120	0.62
SLBF105	9 3/4" Solid 3 1/8" x 2 1/2 x 1 3/8", 6 3/4" Handle Length	EACH	29.00	12	120	0.45
SLBF106	9 3/4" Slotted 3 1/8" x 2 1/2 x 1 3/8", 6 3/4" Handle Length	EACH	28.99	12	120	0.45
<b>Pastry Server</b>						
SLBF109	8 1/2" Pastry Server 5 3/8" x 2 x 1 5/8", 3 3/4" Handle Length	EACH	29.50	12	120	0.53

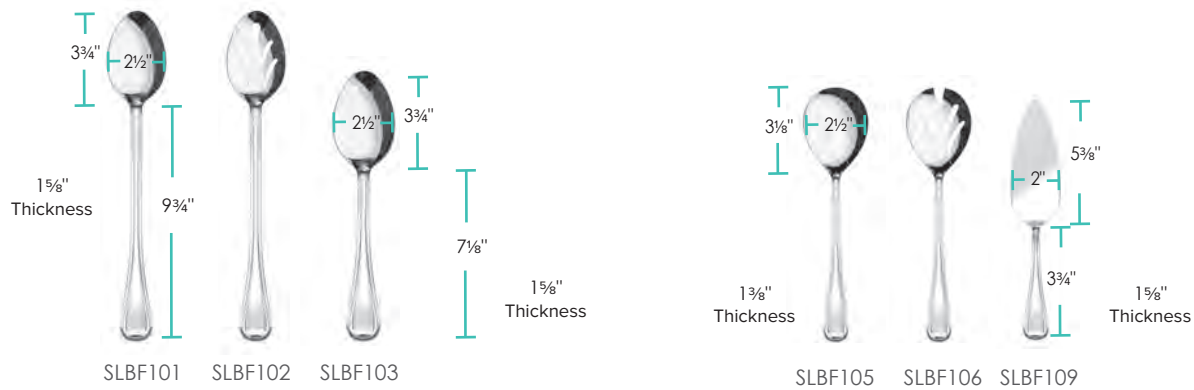

JUICE DISPENSER

ITEM	DESCRIPTION	U/M	WEIGHT GROSS lbs	INNER PACK	MASTER PACK	CU. FT.
SLRCF0031GH	2.2 Gallon, 10" x 13 1/16" x 23 1/4" - Gold Accented Knobs - Stainless Steel Lid & Base - Polycarbonate Body	EACH	12.79	1	1	2.23



SLRCF0031GH





**BUFFETWARE**

One-piece construction. Thick handles with finger grips fit the hand comfortably. A great contribution to buffet serving. Durable and easy to clean.



ITEM	DESCRIPTION	U/M	WEIGHT GROSS lbs	INNER PACK	MASTER PACK	CU. FT.
SLBF001	Solid Serving Spoon 12" x 2 <sup>7</sup> / <sub>16</sub> " x 1"	EACH	38.58	12	144	1.14
SLBF002	Slotted Serving Spoon 11 <sup>7</sup> / <sub>8</sub> " x 2 <sup>7</sup> / <sub>16</sub> " x 1 <sup>1</sup> / <sub>8</sub> "	EACH	36.38	12	144	1.14
SLBF003	Notched Serving Spoon 11 <sup>3</sup> / <sub>4</sub> " x 2 <sup>7</sup> / <sub>16</sub> " x 1"	EACH	34.17	12	144	1.14
SLBF004	2-Tine Pot Fork 11 <sup>1</sup> / <sub>8</sub> " x 1" x 1 <sup>1</sup> / <sub>4</sub> "	EACH	29.76	12	144	0.96
SLBF005	4-Tine Meat Fork 10 <sup>9</sup> / <sub>16</sub> " x 1 <sup>3</sup> / <sub>4</sub> " x <sup>7</sup> / <sub>8</sub> "	EACH	31.97	12	144	1.02
SLBF006	1 oz Spout Ladle 12" x 3 <sup>1</sup> / <sub>4</sub> " x 2"	EACH	49.60	12	144	1.36
SLBF007	2 oz Spout Ladle 12 <sup>1</sup> / <sub>4</sub> " x 3 <sup>5</sup> / <sub>8</sub> " x 3 <sup>1</sup> / <sub>4</sub> "	EACH	55.12	12	144	1.84
SLBF008	4 oz Deep Ladle 12 <sup>1</sup> / <sub>2</sub> " x 3 <sup>5</sup> / <sub>8</sub> " x 3 <sup>1</sup> / <sub>4</sub> "	EACH	61.73	12	144	2.32
SLBF009	Pastry Server 11 <sup>1</sup> / <sub>8</sub> " x 2 <sup>3</sup> / <sub>16</sub> " x 1 <sup>7</sup> / <sub>16</sub> "	EACH	47.40	12	144	1.28
SLBF010	Pie/Cake Server 11 <sup>1</sup> / <sub>2</sub> " x 4" x 2 <sup>1</sup> / <sub>2</sub> "	EACH	52.91	12	144	2.58
SLBF011	Perforated Turner 14 <sup>1</sup> / <sub>4</sub> " x 3 <sup>1</sup> / <sub>4</sub> " x 1 <sup>1</sup> / <sub>8</sub> "	EACH	55.12	12	144	1.40
SLBF012	Round Skimmer 14 <sup>1</sup> / <sub>4</sub> " x 4 <sup>3</sup> / <sub>16</sub> " x 1 <sup>3</sup> / <sub>4</sub> "	EACH	58.42	12	144	2.27
SLBF013	Carving Knife 12 <sup>3</sup> / <sub>4</sub> " x <sup>7</sup> / <sub>8</sub> " x <sup>3</sup> / <sub>8</sub> "	EACH	33.07	12	144	1.09
SLBF014	Slicing Knife 13 <sup>1</sup> / <sub>16</sub> " x 1 <sup>3</sup> / <sub>16</sub> " x <sup>3</sup> / <sub>8</sub> "	EACH	35.27	12	144	1.16
SLBF015	Cheese Plane 11" x 2 <sup>3</sup> / <sub>16</sub> " x 1 <sup>5</sup> / <sub>8</sub> "	EACH	47.40	12	144	1.28



SLOP010 ~ SLOP026



### OVAL PLATTER

Mirror finished.



ITEM	DESCRIPTION	U/M	WEIGHT GROSS lbs	INNER PACK	MASTER PACK	CU. FT.
SLOP010	10" x 7 <sup>3</sup> / <sub>16</sub> " x <sup>3</sup> / <sub>4</sub> "	EACH	29.29	12	72	0.77
SLOP012	12" x 8 <sup>1</sup> / <sub>2</sub> " x <sup>7</sup> / <sub>8</sub> "	EACH	29.60	12	72	0.81
SLOP014	14" x 8 <sup>3</sup> / <sub>4</sub> " x <sup>1</sup> / <sub>2</sub> "	EACH	24.44	12	36	0.62
SLOP016	16" x 10 <sup>5</sup> / <sub>8</sub> " x 1"	EACH	35.16	12	36	0.85
SLOP018	18" x 11 <sup>3</sup> / <sub>4</sub> " x 1 <sup>1</sup> / <sub>4</sub> "	EACH	43.25	12	24	1.10
SLOP020	20" x 13 <sup>3</sup> / <sub>8</sub> " x 1 <sup>1</sup> / <sub>8</sub> "	EACH	48.49	12	24	1.33
SLOP022	22" x 14 <sup>1</sup> / <sub>2</sub> " x 1"	EACH	40.60	18	18	1.00
SLOP024	24" x 16 <sup>3</sup> / <sub>8</sub> " x 1 <sup>1</sup> / <sub>2</sub> "	EACH	34.95	12	12	0.97
SLOP026	26" x 18" x 1 <sup>3</sup> / <sub>16</sub> "	EACH	41.64	12	12	1.14



SLCT310 ~ SLCT318



### ROUND TRAY with NARROW RIM

Edges contoured for tight secure grip.



ITEM	DESCRIPTION	U/M	WEIGHT GROSS lbs	INNER PACK	MASTER PACK	CU. FT.
SLCT310	10" Diameter	EACH	34.61	12	48	1.49
SLCT312	12" Diameter	EACH	46.85	12	48	2.08
SLCT314	14" Diameter	EACH	34.72	12	24	1.43
SLCT316	16" Diameter	EACH	50.15	12	24	1.83
SLCT318	18" Diameter	EACH	62.83	12	24	2.37



SLCS001



### CAKE STAND



ITEM	DESCRIPTION	U/M	WEIGHT GROSS lbs	INNER PACK	MASTER PACK	CU. FT.
SLCS001	13 <sup>1</sup> / <sub>4</sub> " x 6"	EACH	34.00	1	12	5.08

**PLATE COVER**

Mirror finish. Nestles in place during stacked storage, or while in use.



ITEM	DESCRIPTION	U/M	WEIGHT GROSS lbs	INNER PACK	MASTER PACK	CU. FT.
SLPC230	9 3/4" Diameter x 2 1/4" Height	EACH	33.00	12	48	1.37
SLPC250	10" Diameter x 2 3/8" Height	EACH	38.58	12	48	2.01



SLPC230  
SLPC250

**CONDIMENT PACK HOLDER**



ITEM	DESCRIPTION	U/M	WEIGHT GROSS lbs	INNER PACK	MASTER PACK	CU. FT.
SLFC002	Condiment Pack Holder with three divided areas. Fits 1/6 and 1/3 steam pans. 13 1/4" x 16 5/8" x 9"	EACH	29.98	1	4	5.63



SLFC002

\*Steam pan shown - sold separately

**FLATWARE CYLINDER HOLDER**



ITEM	DESCRIPTION	U/M	WEIGHT GROSS lbs	INNER PACK	MASTER PACK	CU. FT.
SLFC004	4 holes - 10 3/8" x 11 7/8" x 8"	EACH	24.25	1	6	4.26
SLFC006	6 holes - 15 1/4" x 11 7/8" x 8"	EACH	22.00	1	4	5.03



SLFC004



SLFC006

**FLATWARE CYLINDER**

Perforated holes for aeration. Outer lip fits perfectly in holders.

With Outer Lip  
Straight Wall Style

ITEM	DESCRIPTION	U/M	WEIGHT GROSS lbs	INNER PACK	MASTER PACK	CU. FT.
PLFC001	Plastic with Outer Lip 4 3/8" Diameter x 5 3/8" Height	DOZEN	13.89	3	6	2.20
SLFC001	Stainless Steel with Outer Lip 4 3/8" Diameter x 5 3/8" Height	EACH	27.00	12	72	1.22
SLFC007	4 3/4" Diameter x 7" Height	EACH	21.78	12	48	5.61
SLFC008	4 1/2" Diameter x 5 1/2" Height	EACH	23.76	12	60	5.31



PLFC001



SLFC001



SLFC007



SLFC008

\*\*No outer lip\*\*



**22 GAUGE ANTI-JAM STEAM PANS (EXTRA HEAVY)**

ITEM	DESCRIPTION	U/M	WEIGHT GROSS lbs	INNER PACK	MASTER PACK	CU. FT.
STPA2001	Full Size 1 1/4" Deep	EACH	28.60	6	12	1.71
STPA2002	Full Size 2 1/2" Deep	EACH	37.05	6	12	2.74
STPA2004	Full Size 4" Deep	EACH	42.86	6	12	4.00
STPA2006	Full Size 6" Deep	EACH	50.12	6	12	4.63
STPA2121	Half Size 1 1/4" Deep	EACH	15.53	12	24	1.62
STPA2122	Half Size 2 1/2" Deep	EACH	39.95	12	24	1.96
STPA2124	Half Size 4" Deep	EACH	47.08	6	24	4.00
STPA2126	Half Size 6" Deep	EACH	53.68	6	12	2.47
STPA2132	Third Size 2 1/2" Deep	EACH	15.27	12	48	2.96
STPA2134	Third Size 4" Deep	EACH	67.14	12	24	2.21
STPA2136	Third Size 6" Deep	EACH	44.18	12	24	2.51
STPA2142	Quarter Size 2 1/2" Deep	EACH	23.32	12	72	3.47
STPA2144	Quarter Size 4" Deep	EACH	0.00	12	48	3.46
STPA2146	Quarter Size 6" Deep	EACH	73.48	12	24	1.92
STPA2162	Sixth Size 2 1/2" Deep	EACH	16.98	12	72	2.50
STPA2164	Sixth Size 4" Deep	EACH	60.02	12	48	2.42
STPA2166	Sixth Size 6" Deep	EACH	51.30	12	48	2.68
STPA2192	Ninth Size 2 1/2" Deep	EACH	22.26	12	72	1.84
STPA2194	Ninth Size 4" Deep	EACH	44.97	12	72	2.73
STPA2122L	Half Size Long 2" Deep	EACH	41.90	12	24	2.36
STPA2124L	Half Size Long 4" Deep	EACH	53.00	12	24	2.61
STPA2126L	Half Size Long 6" Deep	EACH	35.51	6	12	2.13
STPA2232	Two-Thirds Size 2 1/2" Deep	EACH	52.23	12	24	2.88
STPA2234	Two-Thirds Size 4" Deep	EACH	61.90	12	24	3.61
STPA2236	Two-Thirds Size 6" Deep	EACH	38.50	6	12	2.83



STPA2144



**24 GAUGE ANTI-JAM STEAM PANS (HEAVY DUTY)**

ITEM	DESCRIPTION	U/M	WEIGHT GROSS lbs	INNER PACK	MASTER PACK	CU. FT.
STPA3001	Full Size 1 1/4" Deep	EACH	22.97	6	12	2.67
STPA3002	Full Size 2 1/2" Deep	EACH	28.90	6	12	2.67
STPA3004	Full Size 4" Deep	EACH	33.43	6	12	4.00
STPA3006	Full Size 6" Deep	EACH	40.54	6	12	4.63
STPA3121	Half Size 1 1/4" Deep	EACH	23.29	12	24	1.96
STPA3122	Half Size 2 1/2" Deep	EACH	31.50	12	24	1.96
STPA3122L	Half Size Long 2 1/2" Deep	EACH	31.04	12	24	2.20
STPA3124	Half Size 4" Deep	EACH	38.40	6	24	4.00
STPA3124L	Half Size Long 4" Deep	EACH	19.27	6	12	2.20
STPA3126	Half Size 6" Deep	EACH	22.64	6	12	2.47
STPA3126L	Half Size Long 6" Deep	EACH	22.92	6	12	2.56
STPA3132	Third Size 2 1/2" Deep	EACH	45.80	12	48	2.96
STPA3134	Third Size 4" Deep	EACH	26.94	12	24	2.21
STPA3136	Third Size 6" Deep	EACH	34.82	12	24	2.46
STPA3142	Quarter Size 2 1/2" Deep	EACH	53.74	12	72	3.47
STPA3144	Quarter Size 4" Deep	EACH	43.65	12	48	3.46
STPA3146	Quarter Size 6" Deep	EACH	28.91	12	24	1.92
STPA3162	Sixth Size 2 1/2" Deep	EACH	36.03	12	72	2.50
STPA3164	Sixth Size 4" Deep	EACH	30.06	12	48	2.42
STPA3166	Sixth Size 6" Deep	EACH	40.27	12	48	2.58
STPA3192	Ninth Size 2 1/2" Deep	EACH	26.13	12	72	1.84
STPA3194	Ninth Size 4" Deep	EACH	35.95	12	72	2.73
STPA3232	Two-Thirds Size 2 1/2" Deep	EACH	41.00	12	24	2.62
STPA3234	Two-Thirds Size 4" Deep	EACH	47.15	12	24	4.00
STPA3236	Two-Thirds Size 6" Deep	EACH	28.46	6	12	3.14



STPA3132



STPA3236



**25 GAUGE ANTI-JAM STEAM PANS**

ITEM	DESCRIPTION	U/M	WEIGHT GROSS lbs	INNER PACK	MASTER PACK	CU. FT.
STPA4002	Full Size 2½" Deep	EACH	29.61	6	12	2.60
STPA4004	Full Size 4" Deep	EACH	35.03	6	12	4.00
STPA4006	Full Size 6" Deep	EACH	40.03	6	12	4.63
STPA4122	Half Size 2½" Deep	EACH	33.33	12	24	1.96
STPA4124	Half Size 4" Deep	EACH	41.25	6	24	4.00
STPA4126	Half Size 6" Deep	EACH	24.23	6	12	2.47
STPA4132	Third Size 2½" Deep	EACH	45.72	12	48	2.33
STPA4134	Third Size 4" Deep	EACH	27.68	12	24	2.06
STPA4136	Third Size 6" Deep	EACH	36.31	12	24	2.36
STPA4142	Quarter Size 2½" Deep	EACH	56.25	12	72	2.91
STPA4144	Quarter Size 4" Deep	EACH	46.43	12	48	3.46
STPA4146	Quarter Size 6" Deep	EACH	29.35	12	24	1.92
STPA4162	Sixth Size 2½" Deep	EACH	38.75	12	72	2.02
STPA4164	Sixth Size 4" Deep	EACH	33.33	12	48	2.42
STPA4166	Sixth Size 6" Deep	EACH	42.03	12	48	2.58
STPA4192	Ninth Size 2½" Deep	EACH	26.79	12	72	1.61
STPA4194	Ninth Size 4" Deep	EACH	37.86	12	72	2.49

18/8 SS STAINLESS STEEL

25 TRUE GAUGE



STPA4164

**STEAM PAN COVER**

Reinforced edges prevent bending, and fit tightly on steam pans.

ITEM	DESCRIPTION	U/M	WEIGHT GROSS lbs	INNER PACK	MASTER PACK	CU. FT.
STPA5000C	Full Size Solid Cover	EACH	45.44	12	24	3.65
STPA5000CS	Full Size Slotted Cover	EACH	45.02	12	24	3.65
STPA5120C	Half Size Solid Cover	EACH	44.69	12	48	3.78
STPA5120CL	Half Size Long Solid Cover	EACH	23.67	12	24	1.98
STPA5120CS	Half Size Slotted Cover	EACH	44.29	12	48	3.78
STPA5120CSL	Half Size Long Slotted Cover	EACH	23.12	12	24	1.98
STPA5130C	Third Size Solid Cover	EACH	45.88	12	72	3.66
STPA5130CS	Third Size Slotted Cover	EACH	45.07	12	72	3.66
STPA5140C	Quarter Size Solid Cover	EACH	35.29	12	72	3.03
STPA5140CS	Quarter Size Slotted Cover	EACH	34.26	12	72	3.03
STPA5160C	Sixth Size Solid Cover	EACH	23.30	12	72	2.33
STPA5160CS	Sixth Size Slotted Cover	EACH	22.85	12	72	2.33
STPA5190C	Ninth Size Solid Cover	EACH	16.32	12	72	1.55
STPA5190CS	Ninth Size Slotted Cover	EACH	15.87	12	72	1.55
STPA5230C	Two-Thirds Size Solid Cover	EACH	30.26	12	24	2.43
STPA5230CS	Two-Thirds Size Slotted Cover	EACH	29.72	12	24	2.43

STPA5140CS Quarter Size

18/8 SS STAINLESS STEEL

24 TRUE GAUGE



STPA5130CS Third Size

STPA5000CS Full Size

STPA5120CS Half Size

**PERFORATED STEAM PAN**

ITEM	DESCRIPTION	U/M	WEIGHT GROSS lbs	INNER PACK	MASTER PACK	CU. FT.
STPA3001PF	Full Size 1¼" Deep	EACH	22.31	6	12	1.50
STPA3002PF	Full Size 2½" Deep	EACH	26.83	6	12	2.65
STPA3004PF	Full Size 4" Deep	EACH	32.37	6	12	3.25
STPA3006PF	Full Size 6" Deep	EACH	36.71	6	12	3.96
STPA3121PF	Half Size 1¼" Deep	EACH	23.58	12	24	1.60
STPA3122PF	Half Size 2½" Deep	EACH	30.15	12	24	2.44
STPA3124PF	Half Size 4" Deep	EACH	38.71	6	24	3.35
STPA3126PF	Half Size 6" Deep	EACH	22.49	6	12	2.12
STPA3022	Full Size 2½" Deep, Divided	EACH	33.51	6	12	2.65

18/8 SS STAINLESS STEEL

24 TRUE GAUGE



STPA3126PF

IRSC001



9007

**SCISSOR**

Durable steel blades provide long lasting sharpness. Enclosed in plastic grip handles for greater comfort.

ITEM	DESCRIPTION	U/M	WEIGHT GROSS lbs	INNER PACK	MASTER PACK	CU. FT.
IRSC001	7¾"	DOZEN	52.91	1	12	1.15
9007	4"	DOZEN	26.00	1	12	1.46

Made in Taiwan



OW360

**VEGETABLE SHREDDER**

Manual vegetable shredder with turn lever. Comes with 3 shred pattern blades. Stainless steel grater riveted on colored plastic handle.

ITEM	DESCRIPTION	U/M	WEIGHT GROSS lbs	INNER PACK	MASTER PACK	CU. FT.
JAS022006	10¾" x 4¾" 6¾"	EACH	15.43	1	8	2.30
<b>Grater</b>						
PLVS001	15" x 3" Grater, Large	EACH	54.01	12	240	4.18
PLVS002	12¼" x 2¾" Grater, Medium	EACH	41.89	12	240	2.95
PLVS003	10½" x 2½" Grater, Small	EACH	30.12	12	240	2.13
OW360	Multi-Use Slicer	EACH	42.09	12	120	3.84



PLVS001

PLVS002

PLVS003

\* PLVS Comes in assorted colors



JAS022006

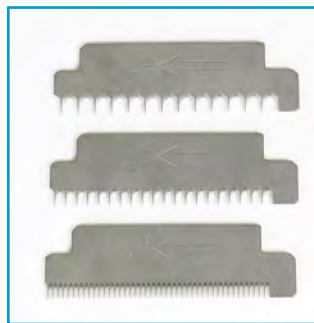

SLMLB002

**MELON BALLER**

Stainless steel mini scoopers fastened onto a wooden handle.

ITEM	DESCRIPTION	U/M	WEIGHT GROSS lbs	INNER PACK	MASTER PACK	CU. FT.
SLMLB002	7" x 1¾" x 5/16" With Wooden Center Grip	EACH	14.30	36	144	0.45

**ADAPTOR BAR**

ITEM	DESCRIPTION	U/M	WEIGHT GROSS lbs	INNER PACK	MASTER PACK	CU. FT.
SLTHAB012	12" x 1" x 3/8" Adaptor Bar w/Groove	EACH	28.00	24	144	0.51
SLTHAB020	20" x 1" x 3/8" Adaptor Bar w/Groove	EACH	37.48	24	120	0.73
SLTHAB012D	12" x 1" x 1/2" Adaptor Bar	EACH	26.62	24	144	0.60
SLTHAB020D	20" x 1" x 1/2" Adaptor Bar	EACH	36.70	24	120	0.99

Made in Taiwan

Made in Taiwan

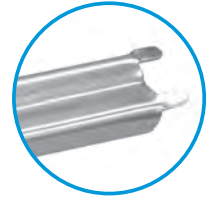

SLTHAB012  
STEAM PAN & WATER PAN  
SOLD SEPERATELY

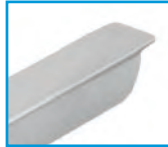

SLTHAB012

SLTHAB020D

SLTHAB012D

**FUNNEL**

ITEM	DESCRIPTION	U/M	WEIGHT GROSS lbs	INNER PACK	MASTER PACK	CU. FT.
<b>Plastic</b>						
*15 mm tube's outer diameter.						
PLFN004	4 1/8" Diameter, 8 oz, Tube Diameter = 0.6"	EACH	19.14	12	360	3.02
PLFN005	5 1/4" Diameter, 16 oz, Tube Diameter = 0.6"	EACH	23.80	12	360	4.62
PLFN006	6 1/4" Diameter, 32 oz, Tube Diameter = 0.6"	EACH	35.00	12	360	5.93
<b>Stainless Steel</b>						
*17 mm tube's outer diameter. Removable strainer						
SLFN005	5" Diameter x 5 7/8" Length, 11 1/2 oz	EACH	9.70	1	36	3.40
SLFN006	6" Diameter x 6 3/4" Length, 18 oz	EACH	14.00	1	36	4.29

Made in Taiwan

Made in Taiwan

Made in Taiwan

SS STAINLESS STEEL



PLFN004



PLFN005



PLFN006



SLFN005



SLFN006



SLIC001

### INSET COVER - DIVIDED

- \* Plastic Knob
- \* Notch on side for ladle



ITEM	DESCRIPTION	U/M	WEIGHT GROSS lbs	INNER PACK	MASTER PACK	CU. FT.
SLIC001	10" Diameter, 7 qt	EACH	22.05	6	24	2.75
SLIC002	12" Diameter, 11 qt	EACH	29.76	6	24	3.73



ALWP001

### WATER PAN



ITEM	DESCRIPTION	U/M	WEIGHT GROSS lbs	INNER PACK	MASTER PACK	CU. FT.
ALWP001	25 qt 20 <sup>3</sup> / <sub>4</sub> " x 12 <sup>3</sup> / <sub>4</sub> " x 6 <sup>1</sup> / <sub>2</sub> ", 1mm	EACH	15.87	6	6	2.24



SLSPG001

### SPILLAGE PAN



ITEM	DESCRIPTION	U/M	WEIGHT GROSS lbs	INNER PACK	MASTER PACK	CU. FT.
SLSPG001	25 qt 21" x 13" x 6", 0.7mm	EACH	24.25	6	6	2.72



SLTHFB010

### FALSE BOTTOM

For use with steam table pans. Holds foods above pan bottom for draining.



ITEM	DESCRIPTION	U/M	WEIGHT GROSS lbs	INNER PACK	MASTER PACK	CU. FT.
SLTHFB010	10 <sup>1</sup> / <sub>2</sub> " x 8 <sup>1</sup> / <sub>4</sub> " x <sup>3</sup> / <sub>8</sub> "	EACH	26.46	1	24	0.77
SLTHFB017	17" x 8 <sup>3</sup> / <sub>4</sub> " x <sup>3</sup> / <sub>8</sub> "	EACH	47.40	1	24	1.50



SLPHAP068

### ADAPTOR PLATE



ITEM	DESCRIPTION	U/M	WEIGHT GROSS lbs	INNER PACK	MASTER PACK	CU. FT.
SLPHAP066	Two 6 <sup>1</sup> / <sub>2</sub> " Holes Fits 4 qt Inset Pans 20 <sup>3</sup> / <sub>16</sub> " x 12 <sup>7</sup> / <sub>8</sub> "	EACH	57.00	1	24	0.55
SLPHAP068	One 6 <sup>1</sup> / <sub>2</sub> ", & One 8 <sup>1</sup> / <sub>2</sub> " Hole Fits 4 qt & 7 qt Inset Pans 20 <sup>3</sup> / <sub>16</sub> " x 12 <sup>7</sup> / <sub>8</sub> "	EACH	49.00	1	24	0.55
SLPHAP088	Two 8 <sup>1</sup> / <sub>2</sub> " Holes Fits 7 qt Inset Pans 20 <sup>3</sup> / <sub>16</sub> " x 12 <sup>7</sup> / <sub>8</sub> "	EACH	43.00	1	24	0.55

## BAIN MARIE POT & COVER

Polished exterior and satin interior. Stackable cover fits perfectly on pot.



ITEM	DESCRIPTION	U/M	WEIGHT GROSS lbs	INNER PACK	MASTER PACK	CU. FT.
<b>Pot</b>						
SLBM001	1½ qt Bain Marie Pot 4⅞" Diameter x 5¼" Height	EACH	15.40	6	24	1.48
SLBM002	2 qt Bain Marie Pot 4⅞" Diameter x 6¼" Height	EACH	20.13	6	24	2.15
SLBM003	3½ qt Bain Marie Pot 7" Diameter x 7¾" Height	EACH	26.75	6	24	3.28
SLBM004	4¼ qt Bain Marie Pot 7⅞" Diameter x 7¾" Height	EACH	17.35	6	12	1.46
SLBM005	6 qt Bain Marie Pot 8" Diameter x 8½" Height	EACH	22.45	6	12	4.57
SLBM006	8¼ qt Bain Marie Pot 8⅞" Diameter x 9¾" Height	EACH	26.60	6	12	5.68
<b>Cover</b>						
SLBM007	Fits 1½ qt, SLBM001	EACH	26.86	12	144	1.78
SLBM008	Fits 2 qt, SLBM001	EACH	32.89	12	144	2.03
SLBM009	Fits 3½ qt, SLBM001	EACH	44.95	12	144	3.63
SLBM010	Fits 4¼ qt, SLBM001	EACH	27.02	12	72	2.17
SLBM011	Fits 6 qt SLBM001	EACH	30.83	6	72	3.79
SLBM012	Fits 8¼ qt SLBM001	EACH	25.27	6	48	2.06

**\* IMPROVED \***

COVER  
SLBM007 ~ SLBM012



POT  
SLBM001 ~ SLBM006

## INSET PAN & COVER

Mirror-polished exterior and satin finish interior.



ITEM	DESCRIPTION	U/M	WEIGHT GROSS lbs	INNER PACK	MASTER PACK	CU. FT.
<b>Pan</b>						
SLIP001	2½ qt Inset Pan 5⅞" Diameter x 7½" Height	EACH	27.50	6	36	2.31
SLIP002	4 qt Inset Pan 7⅞" Diameter x 8" Height	EACH	45.24	6	36	4.37
SLIP003	7 qt Inset Pan 9½" Diameter x 8¼" Height	EACH	40.13	6	24	4.42
SLIP004	11 qt Inset Pan 11⅞" Diameter x 8" Height	EACH	54.21	6	24	6.14
<b>Cover</b>						
SLIP005	Fits 2½ qt, SLIP001	EACH	19.29	6	72	1.02
SLIP006	Fits 4 qt, SLIP002	EACH	30.24	6	72	1.56
SLIP007	Fits 7 qt, SLIP003	EACH	31.88	6	48	1.78
SLIP008	Fits 11 qt, SLIP004	EACH	32.78	6	36	2.67

COVER  
SLIP005 ~ SLIP008



INSET PAN  
SLIP001 ~ SLIP004

## PAIL

With swing handle.



ITEM	DESCRIPTION	U/M	WEIGHT GROSS lbs	INNER PACK	MASTER PACK	CU. FT.
SLPAL002	2 qt, 6½" Diameter x 6¼" Height w/3½" handle Length	EACH	49.50	12	72	2.93
SLPAL006	6 qt, 8⅞" Diameter x 9½" Height w/5" handle Length	EACH	37.04	12	24	2.11
SLPAL009	9 qt, 10" Diameter x 10¼" Height w/5" handle Length	EACH	23.50	12	12	1.22
SLPAL013	13 qt, 11⅞" Diameter x 11" Height w/6" handle Length	EACH	27.60	12	12	1.59



SLPAL002 ~ SLPAL013

## ROUND FOOD STORAGE CONTAINERS

### CLEAR



ITEM	DESCRIPTION	U/M	WEIGHT GROSS lbs	INNER PACK	MASTER PACK	CU. FT.
PLRFT301PC	1 qt, 5 1/2" Diameter x 5" Height	EACH	19.73	6	48	2.35
PLRFT302PC	2 qt, 7 3/8" Diameter x 4 1/4" Height	EACH	15.26	12	24	2.02
PLRFT304PC	4 qt, 7 3/8" Diameter x 8 1/2" Height	EACH	11.93	12	12	1.31
PLRFT306PC	6 qt, 8 5/8" Diameter x 7 5/8" Height	EACH	12.57	12	12	1.84
PLRFT308PC	8 qt, 8 5/8" Diameter x 10 5/8" Height	EACH	16.36	12	12	2.21
PLRFT312PC	12 qt, 12 3/8" Diameter x 8 3/4" Height	EACH	23.88	12	12	4.16
PLRFT318PC	18 qt, 12 3/8" Diameter x 12" Height	EACH	16.36	6	6	2.81
PLRFT322PC	22 qt, 12 3/8" Diameter x 14 3/8" Height	EACH	20.08	6	6	3.40

### TRANSLUCENT



ITEM	DESCRIPTION	U/M	WEIGHT GROSS lbs	INNER PACK	MASTER PACK	CU. FT.
PLRFT301TL	1 qt, 5 1/2" Diameter x 5" Height	EACH	19.73	6	48	2.35
PLRFT302TL	2 qt, 7 3/8" Diameter x 4 1/4" Height	EACH	15.26	12	24	2.02
PLRFT304TL	4 qt, 7 3/8" Diameter x 8 1/2" Height	EACH	11.93	12	12	1.31
PLRFT306TL	6 qt, 8 5/8" Diameter x 7 5/8" Height	EACH	12.57	12	12	1.84
PLRFT308TL	8 qt, 8 5/8" Diameter x 10 5/8" Height	EACH	16.36	12	12	2.21
PLRFT312TL	12 qt, 12 3/8" Diameter x 8 3/4" Height	EACH	23.88	12	12	4.16
PLRFT318TL	18 qt, 12 3/8" Diameter x 12" Height	EACH	16.36	6	6	2.81
PLRFT322TL	22 qt, 12 3/8" Diameter x 14 3/8" Height	EACH	20.08	6	6	3.40

**WHITE**



POLYPROPYLENE

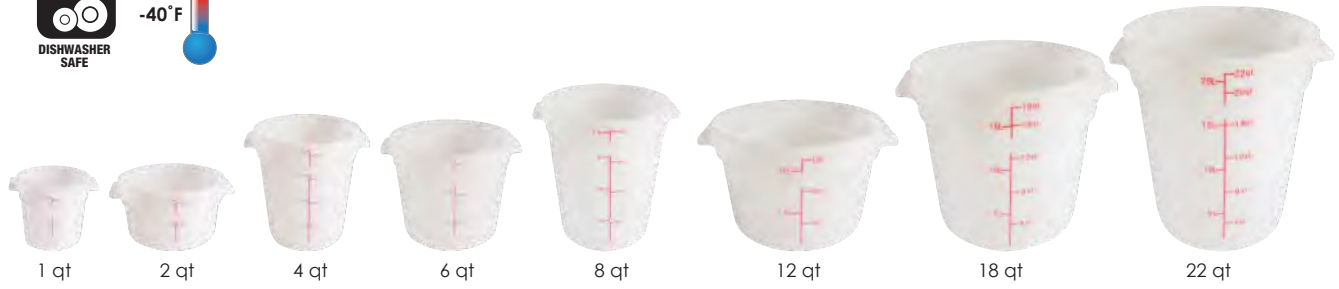

ITEM	DESCRIPTION	U/M	WEIGHT GROSS lbs	INNER PACK	MASTER PACK	CU. FT.
PLRFT301PP	1 qt, 5 1/8" Diameter x 5" Height	EACH	19.73	6	48	2.35
PLRFT302PP	2 qt, 7 3/8" Diameter x 4 1/4" Height	EACH	15.26	12	24	2.02
PLRFT304PP	4 qt, 7 7/8" Diameter x 8 1/2" Height	EACH	11.93	12	12	1.31
PLRFT306PP	6 qt, 8 3/8" Diameter x 7 5/8" Height	EACH	12.57	12	12	1.84
PLRFT308PP	8 qt, 8 7/8" Diameter x 10 1/8" Height	EACH	16.36	12	12	2.21
PLRFT312PP	12 qt, 12 3/8" Diameter x 8 3/4" Height	EACH	23.88	12	12	4.16
PLRFT318PP	18 qt, 12 3/8" Diameter x 12" Height	EACH	16.36	6	6	2.81
PLRFT322PP	22 qt, 12 3/8" Diameter x 14 7/8" Height	EACH	20.08	6	6	3.40

**LIDS**



ITEM	DESCRIPTION	U/M	WEIGHT GROSS lbs	INNER PACK	MASTER PACK	CU. FT.
<b>White</b>						
PLRFC0001PP	Fits 1 qt, PLRFT301PP	EACH	1.32	12	12	0.10
PLRFC0204PP	Fits 2 & 4 qt, PLRFT302PP & 304PP	EACH	5.00	12	12	0.25
PLRFC0608PP	Fits 6 & 8 qt, PLRFT306PP & 308PP	EACH	4.12	12	12	0.41
PLRFC121822PP	Fits 12, 18 & 22 qt, PLRFT312, 318, 322PP	EACH	4.96	6	6	0.45
<b>Translucent</b>						
PLRFC0001TL	Fits 1 qt, PLRFT301TL	EACH	1.32	12	12	0.10
PLRFC0204TL	Fits 2 & 4 qt, PLRFT302TL & PLRFT304TL	EACH	5.00	12	12	0.25
PLRFC0608TL	Fits 6 & 8 qt, PLRFT306TL & PLRFT308TL	EACH	4.12	12	12	0.41
PLRFC121822TL	Fits 12, 18 & 22 qt, PLRFT312TL, PLRFT-318TL & PLRFT322TL	EACH	4.96	6	6	0.45
<b>Clear</b>						
PLRFC0001PC	Fits 1 qt, PLRFT301PC	EACH	1.32	12	12	0.10
PLRFC0204PC	Fits 2 & 4 qt, PLRFT302PC & PLRFT304PC	EACH	5.00	12	12	0.25
PLRFC0608PC	Fits 6 & 8 qt, PLRFT306PC & PLRFT308PC	EACH	4.12	12	12	0.41
PLRFC121822PC	Fits 12, 18 & 22 qt, PLRFT312PC, PLRFT318PC & PLRFT322PC	EACH	4.96	6	6	0.45

**SQUARE FOOD STORAGE CONTAINERS**

**CLEAR  
(POLYCARBONATE)**



SHATTER RESISTANT



SCRATCH RESISTANT



DISHWASHER SAFE

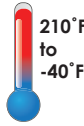

\*Lids Sold Separately

ITEM	DESCRIPTION	U/M	WEIGHT GROSS lbs	INNER PACK	MASTER PACK	CU. FT.
PLSFT002PC	2 qt, 7 <sup>1</sup> / <sub>16</sub> " x 7" x 4"	EACH	16.31	6	24	2.05
PLSFT004PC	4 qt, 7 <sup>1</sup> / <sub>16</sub> " x 7" x 7 <sup>1</sup> / <sub>2</sub> "	EACH	24.12	6	24	2.84
PLSFT006PC	6 qt, 8 <sup>7</sup> / <sub>16</sub> " x 8 <sup>7</sup> / <sub>16</sub> " x 7 <sup>1</sup> / <sub>2</sub> "	EACH	35.58	6	24	4.57
PLSFT008PC	8 qt, 8 <sup>7</sup> / <sub>16</sub> " x 8 <sup>7</sup> / <sub>16</sub> " x 9"	EACH	41.38	6	24	4.96
PLSFT012PC	12 qt, 11 <sup>1</sup> / <sub>4</sub> " x 11 <sup>3</sup> / <sub>8</sub> " x 8 <sup>1</sup> / <sub>4</sub> "	EACH	32.25	6	12	4.02
PLSFT018PC	18 qt, 11 <sup>1</sup> / <sub>4</sub> " x 11 <sup>3</sup> / <sub>8</sub> " x 12 <sup>3</sup> / <sub>8</sub> "	EACH	41.36	6	12	4.72
PLSFT022PC	22 qt, 11 <sup>1</sup> / <sub>4</sub> " x 11 <sup>3</sup> / <sub>8</sub> " x 15 <sup>3</sup> / <sub>4</sub> "	EACH	49.85	6	12	5.37

**TRANSLUCENT  
(POLYPROPYLENE)**



DISHWASHER SAFE

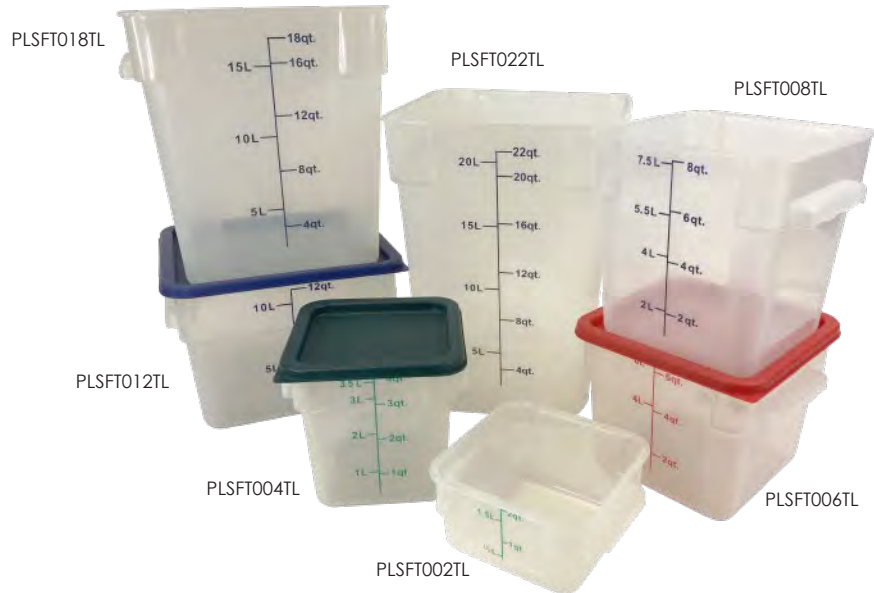

ITEM	DESCRIPTION	U/M	WEIGHT GROSS lbs	INNER PACK	MASTER PACK	CU. FT.
PLSFT002TL	2 qt, 7 <sup>1</sup> / <sub>16</sub> " x 7" x 4"	EACH	13.29	6	24	2.05
PLSFT004TL	4 qt, 7 <sup>1</sup> / <sub>16</sub> " x 7" x 7 <sup>1</sup> / <sub>2</sub> "	EACH	19.07	6	24	2.85
PLSFT006TL	6 qt, 8 <sup>7</sup> / <sub>16</sub> " x 8 <sup>7</sup> / <sub>16</sub> " x 7 <sup>1</sup> / <sub>2</sub> "	EACH	27.82	6	24	4.55
PLSFT008TL	8 qt, 8 <sup>7</sup> / <sub>16</sub> " x 8 <sup>7</sup> / <sub>16</sub> " x 9"	EACH	26.19	6	24	4.96
PLSFT012TL	12 qt, 11 <sup>1</sup> / <sub>4</sub> " x 11 <sup>3</sup> / <sub>8</sub> " x 8 <sup>1</sup> / <sub>4</sub> "	EACH	23.57	6	12	4.02
PLSFT018TL	18 qt, 11 <sup>1</sup> / <sub>4</sub> " x 11 <sup>3</sup> / <sub>8</sub> " x 12 <sup>3</sup> / <sub>8</sub> "	EACH	30.31	6	12	4.72
PLSFT022TL	22 qt, 11 <sup>1</sup> / <sub>4</sub> " x 11 <sup>3</sup> / <sub>8</sub> " x 15 <sup>3</sup> / <sub>4</sub> "	EACH	39.55	6	12	5.37





**WHITE  
(POLYPROPYLENE)**



\*Lids Sold separately

ITEM	DESCRIPTION	U/M	WEIGHT GROSS lbs	INNER PACK	MASTER PACK	CU. FT.
PLSFT002PP	2 qt, 7 <sup>1</sup> / <sub>6</sub> " x 7" x 4"	EACH	13.29	6	24	2.05
PLSFT004PP	4 qt, 7 <sup>1</sup> / <sub>6</sub> " x 7" x 7 <sup>1</sup> / <sub>2</sub> "	EACH	19.07	6	24	2.85
PLSFT006PP	6 qt, 8 <sup>7</sup> / <sub>8</sub> " x 8 <sup>9</sup> / <sub>7</sub> " x 7 <sup>1</sup> / <sub>2</sub> "	EACH	27.82	6	24	4.55
PLSFT008PP	8 qt, 8 <sup>7</sup> / <sub>8</sub> " x 8 <sup>9</sup> / <sub>7</sub> " x 9"	EACH	26.19	6	24	4.96
PLSFT012PP	12 qt, 11 <sup>1</sup> / <sub>4</sub> " x 11 <sup>3</sup> / <sub>8</sub> " x 8 <sup>1</sup> / <sub>4</sub> "	EACH	23.57	6	12	4.02
PLSFT018PP	18 qt, 11 <sup>1</sup> / <sub>4</sub> " x 11 <sup>3</sup> / <sub>8</sub> " x 12 <sup>3</sup> / <sub>8</sub> "	EACH	30.31	6	12	4.72
PLSFT022PP	22 qt, 11 <sup>1</sup> / <sub>4</sub> " x 11 <sup>3</sup> / <sub>8</sub> " x 15 <sup>3</sup> / <sub>4</sub> "	EACH	39.55	6	12	5.37

**SQUARE LID**

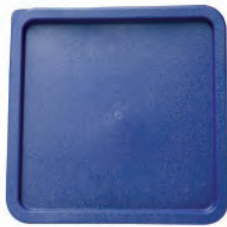

PLSFT121822C



PLSFT0608C



PLSFT0204C

ITEM	DESCRIPTION	U/M	WEIGHT GROSS lbs	INNER PACK	MASTER PACK	CU. FT.
PLSFT0204C	Fits 2 qt & 4 qt Green, PLSFT002 & PLSFT004 (PC/TL/PP)	EACH	3.26	6	12	0.31
PLSFT0608C	Fits 6 qt & 8 qt Red, PLSFT006 & PLSFT008(PC/TL/PP)	EACH	4.50	6	12	0.43
PLSFT121822C	Fits 12 qt, 18 qt & 22 qt Blue, PLSFT012, PLSFT018 & PLSFT022 (PC/TL/PP)	EACH	7.54	6	12	0.73



non-slip texture

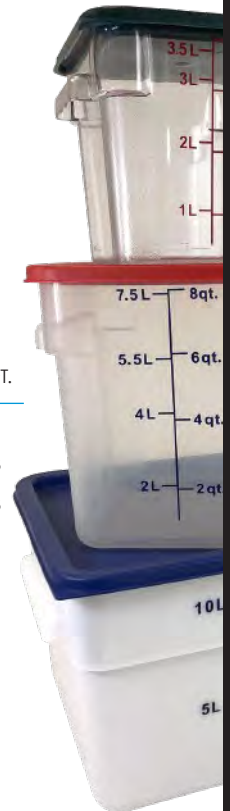



### POLYCARBONATE FOOD PAN - CLEAR

Lids and drain shelves are sold separately.



ITEM	DESCRIPTION	U/M	WEIGHT GROSS lbs	INNER PACK	MASTER PACK	CU. FT.
PLPA8002	Full Size 2½" Deep	EACH	25.18	6	12	3.10
PLPA8004	Full Size 4" Deep	EACH	29.87	6	12	4.00
PLPA8006	Full Size 6" Deep	EACH	36.68	6	12	4.85
PLPA8008	Full Size 8" Deep	EACH	48.63	6	12	5.90
PLPA8122	Half Size 2½" Deep	EACH	24.47	12	24	2.71
PLPA8124	Half Size 4" Deep	EACH	31.08	6	24	3.93
PLPA8126	Half Size 6" Deep	EACH	20.50	6	12	2.54
PLPA8128	Half Size 8" Deep	EACH	22.71	6	12	3.00
PLPA8122L	Half Size Long 2½" Deep	EACH	20.94	6	24	2.10
PLPA8124L	Half Size Long 4" Deep	EACH	13.89	6	12	1.38
PLPA8132	Third Size 2½" Deep	EACH	16.98	12	24	1.93
PLPA8134	Third Size 4" Deep	EACH	21.61	12	24	2.40
PLPA8136	Third Size 6" Deep	EACH	33.51	6	24	3.59
PLPA8138	Third Size 8" Deep	EACH	19.40	6	12	2.10
PLPA8142	Quarter Size 2½" Deep	EACH	21.83	6	36	2.59
PLPA8144	Quarter Size 4" Deep	EACH	23.59	6	36	2.96
PLPA8146	Quarter Size 6" Deep	EACH	21.61	6	24	2.53
PLPA8162	Sixth Size 2½" Deep	EACH	13.23	12	36	1.39
PLPA8164	Sixth Size 4" Deep	EACH	21.16	12	48	2.29
PLPA8166	Sixth Size 6" Deep	EACH	14.99	6	24	1.71
PLPA8192	Ninth Size 2½" Deep	EACH	16.09	12	72	1.80
PLPA8194	Ninth Size 4" Deep	EACH	21.38	12	72	2.40

2½", 4", 6", 8"  
Depth Available



### POLYCARBONATE FOOD PAN LID

The clear lid makes it easy to view contents inside the food pans. Rigid built-in handle provides a secure grip.



ITEM	DESCRIPTION	U/M	WEIGHT GROSS lbs	INNER PACK	MASTER PACK	CU. FT.
<b>Solid</b>						
PLPA7000C	Full Size Solid Lid	EACH	34.17	12	24	2.44
PLPA7120C	Half Size Solid Lid	EACH	33.73	12	48	2.78
PLPA7120LC	Half Size Long Solid Lid	EACH	15.43	12	24	1.19
PLPA7130C	Third Size Solid Lid	EACH	31.53	12	72	3.00
PLPA7140C	Quarter Size Solid Lid	EACH	26.46	12	72	2.39
PLPA7160C	Sixth Size Solid Lid	EACH	20.28	12	72	1.61
PLPA7190C	Ninth Size Solid Lid	EACH	13.56	12	72	0.65
<b>Slotted</b>						
PLPA7000CS	Full Size Slotted Lid	EACH	34.17	12	24	2.44
PLPA7120CS	Half Size Slotted Lid	EACH	33.73	12	48	2.78
PLPA7130CS	Third Size Slotted Lid	EACH	31.53	12	72	3.00
PLPA7140CS	Quarter Size Slotted Lid	EACH	26.46	12	72	2.39
PLPA7160CS	Sixth Size Slotted Lid	EACH	20.28	12	72	1.61
PLPA7190CS	Ninth Size Slotted Lid	EACH	13.56	12	72	0.65



PLPA7000CS



PLPA7000C



PLPA7120CS



PLPA7140C



PLPA7140CS



PLPA7120DS

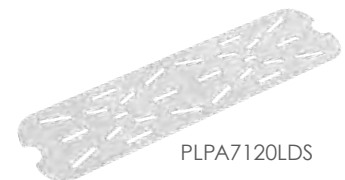

PLPA7120LDS



PLPA7160DS

### POLYCARBONATE FOOD PAN DRAIN SHELF

The sturdy feet help to support contents and allow room for easy drainage.



ITEM	DESCRIPTION	U/M	WEIGHT GROSS lbs	INNER PACK	MASTER PACK	CU. FT.
PLPA7000DS	Full size	EACH	26.01	10	20	2.01
PLPA7120DS	Half size	EACH	9.92	10	20	0.72
PLPA7120LDS	Half Size Long	EACH	6.17	10	20	0.66
PLPA7130DS	Third size	EACH	13.67	20	40	1.04
PLPA7140DS	Quarter size	EACH	6.83	20	40	0.69
PLPA7160DS	Sixth size	EACH	5.73	20	60	0.64



**POLYCARBONATE FOOD PAN - BLACK**

Lids and drain shelves are sold separately.

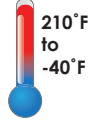

ITEM	DESCRIPTION	U/M	WEIGHT GROSS lbs	INNER PACK	MASTER PACK	CU. FT.
PLPA8002BK	Full Size 2 1/2" Deep	EACH	25.18	6	12	3.10
PLPA8004BK	Full Size 4" Deep	EACH	29.87	6	12	4.00
PLPA8006BK	Full Size 6" Deep	EACH	36.68	6	12	4.85
PLPA8008BK	Full Size 8" Deep	EACH	48.63	6	12	5.90
PLPA8122BK	Half Size 2 1/2" Deep	EACH	24.47	12	24	2.71
PLPA8124BK	Half Size 4" Deep	EACH	31.08	6	24	3.93
PLPA8126BK	Half Size 6" Deep	EACH	20.5	6	12	2.54
PLPA8128BK	Half Size 8" Deep	EACH	22.71	6	12	3.00
PLPA8122LBK	Half Size Long 2 1/2" Deep	EACH	20.94	6	24	2.10
PLPA8124LBK	Half Size Long 4" Deep	EACH	13.89	6	12	1.38
PLPA8132BK	Third Size 2 1/2" Deep	EACH	16.98	12	24	1.93
PLPA8134BK	Third Size 4" Deep	EACH	21.61	12	24	2.40
PLPA8136BK	Third Size 6" Deep	EACH	33.51	6	24	3.59
PLPA8138BK	Third Size 8" Deep	EACH	19.4	6	12	2.10
PLPA8142BK	Quarter Size 2 1/2" Deep	EACH	21.83	6	36	2.59
PLPA8144BK	Quarter Size 4" Deep	EACH	23.59	6	36	2.96
PLPA8146BK	Quarter Size 6" Deep	EACH	21.61	6	24	2.53
PLPA8162BK	Sixth Size 2 1/2" Deep	EACH	13.23	12	36	1.39
PLPA8164BK	Sixth Size 4" Deep	EACH	21.16	12	48	2.29
PLPA8166BK	Sixth Size 6" Deep	EACH	14.99	6	24	1.71
PLPA8192BK	Ninth Size 2 1/2" Deep	EACH	16.09	12	72	1.80
PLPA8194BK	Ninth Size 4" Deep	EACH	21.38	12	72	2.40

2 1/2", 4", 6", 8"  
Depth Available



**POLYCARBONATE FOOD PAN LID - BLACK**



POLYCARBONATE



ITEM	DESCRIPTION	U/M	WEIGHT GROSS lbs	INNER PACK	MASTER PACK	CU. FT.
<b>Solid</b>						
PLPA7000CBK	Full Size Solid Lid	EACH	34.17	12	24	2.44
PLPA7120CBK	Half Size Solid Lid	EACH	33.73	12	48	2.78
PLPA7120LCBK	Half Size Long Solid Lid	EACH	15.43	12	24	1.19
PLPA7130CBK	Third Size Solid Lid	EACH	31.53	12	72	3.00
PLPA7140CBK	Quarter Size Solid Lid	EACH	26.46	12	72	2.39
PLPA7160CBK	Sixth Size Solid Lid	EACH	20.28	12	72	1.61
PLPA7190CBK	Ninth Size Solid Lid	EACH	13.56	12	72	0.65
<b>Slotted</b>						
PLPA7000CSBK	Full Size Slotted Lid	EACH	34.17	12	24	2.44
PLPA7120CSBK	Half Size Slotted Lid	EACH	33.73	12	48	2.78
PLPA7130CSBK	Third Size Slotted Lid	EACH	31.53	12	72	3.00
PLPA7140CSBK	Quarter Size Slotted Lid	EACH	26.46	12	72	2.39
PLPA7160CSBK	Sixth Size Slotted Lid	EACH	20.28	12	72	1.61
PLPA7190CSBK	Ninth Size Slotted Lid	EACH	13.56	12	72	0.65



PLPA7000CBK



PLPA7120CSBK



PLPA7120CBK



PLPA7120LCBK



PLPA7160CSBK

**POLYCARBONATE FOOD PAN DRAIN SHELF - BLACK**

The sturdy feet help to support contents and allow room for easy drainage.



POLYCARBONATE



ITEM	DESCRIPTION	U/M	WEIGHT GROSS lbs	INNER PACK	MASTER PACK	CU. FT.
PLPA7000DSBK	Full Size	EACH	26.01	10	20	2.01
PLPA7120DSBK	Half Size	EACH	9.92	10	20	0.72
PLPA7120LDSBK	Half Size	EACH	6.17	10	20	0.66
PLPA7130DSBK	Third Size	EACH	13.67	20	40	1.04
PLPA7140DSBK	Quarter Size	EACH	6.83	20	40	0.69
PLPA7160DSBK	Sixth Size	EACH	5.73	20	60	0.64



PLPA7120LDSBK



PLPA7120DSBK



PLPA7160DSBK

**POLYCARBONATE FOOD STORAGE BOX - CLEAR**

**12" X 18"**

Lids and drain shelves are sold separately.



POLYCARBONATE

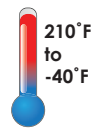

PLFBC1218PC



PLFBD1218PC

12" x 18" comes in 3 sizes of depth:



ITEM	DESCRIPTION	U/M	WEIGHT GROSS lbs	INNER PACK	MASTER PACK	CU. FT.
PLFB121803PC	12" x 18" x 3 1/2", 1.75 Gallon	EACH	22.95	12	12	3.16
PLFB121806PC	12" x 18" x 6", 3 Gallon	EACH	31.78	12	12	3.47
PLFB121809PC	12" x 18" x 9", 4.75 Gallon	EACH	39.37	12	12	3.88
PLFBC1218PC	Lid for 12" x 18"	EACH	16.26	12	12	0.85
PLFBD1218PC	Drain Shelf Fits 12" x 18"	EACH	14.12	24	24	0.78

**18" X 26"**

Lids and drain shelves are sold separately.



PLFBC1826PC



PLFBD1826PC

18" x 26" comes in 5 sizes of depth:



ITEM	DESCRIPTION	U/M	WEIGHT GROSS lbs	INNER PACK	MASTER PACK	CU. FT.
PLFB182603PC	18" x 26" x 3 1/2", 5 Gallon	EACH	25.42	6	6	3.74
PLFB182606PC	18" x 26" x 6", 8.75 Gallon	EACH	29.87	6	6	4.31
PLFB182609PC	18" x 26" x 9", 13 Gallon	EACH	37.81	6	6	5.24
PLFB182612PC	18" x 26" x 12", 17 Gallon	EACH	46.38	6	6	6.66
PLFB182615PC	18" x 26" x 15", 22 Gallon	EACH	61.94	6	6	8.57
PLFBC1826PC	Lid For 12" x 26"	EACH	32.03	12	12	1.69
PLFBD1826PC	Drain Shelf Fits 18" x 26"	EACH	53.40	24	24	2.05

POLYPROPYLENE FOOD STORAGE BOX - WHITE

12" X 18"



POLYPROPYLENE



LFBC1218PP



PLFBD1218PP

12" x 18" comes in 3 sizes of depth:



ITEM	DESCRIPTION	U/M	WEIGHT GROSS lbs	INNER PACK	MASTER PACK	CU. FT.
PLFB121803PP	12" x 18" x 3 1/2", 1.75 Gallon	EACH	16.2	12	12	3.14
PLFB121806PP	12" x 18" x 6", 3 Gallon	EACH	22.65	12	12	3.46
PLFB121809PP	12" x 18" x 9", 4.75 Gallon	EACH	28.87	12	12	3.88
PLFBC1218PP	Lid For Half Size	EACH	10.66	12	12	0.74
PLFBD1218PP	Drain Shelf Fits 12" x 18"	EACH	10.94	24	24	0.78

18" X 26"



PLFBC1826PP



PLFBD1826PP

18" x 26" comes in 5 sizes of depth:



ITEM	DESCRIPTION	U/M	WEIGHT GROSS lbs	INNER PACK	MASTER PACK	CU. FT.
PLFB182603PP	18" x 26" x 3 1/2", 5 Gallon	EACH	18.68	6	6	3.74
PLFB182606PP	18" x 26" x 6", 8.75 Gallon	EACH	21.67	6	6	4.31
PLFB182609PP	18" x 26" x 9", 13 Gallon	EACH	27.32	6	6	5.23
PLFB182612PP	18" x 26" x 12", 17 Gallon	EACH	33.35	6	6	6.67
PLFB182615PP	18" x 26" x 15", 22 Gallon	EACH	44.74	6	6	8.58
PLFBC1826PP	Lid For Full Size	EACH	23.27	12	12	1.59
PLFBD1826PP	Drain Shelf Fits 18" x 26"	EACH	40.44	24	24	2.05

## DOUGH BOX AND COVER

Stackable space-saving design.



POLYPROPYLENE

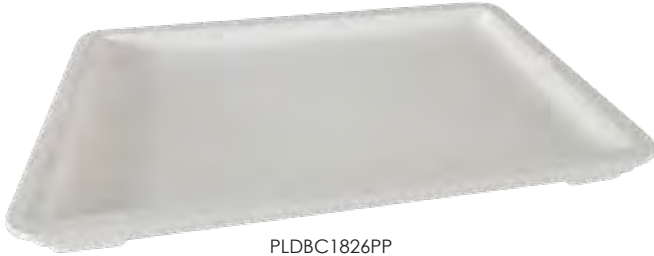

PLDBC1826PP  
Cover



PLDB182603PP  
3"



PLDB182606PP  
6"

ITEM	DESCRIPTION	U/M	WEIGHT GROSS lbs	INNER PACK	MASTER PACK	CU. FT.
PLDB182603PP	18" x 26" x 3"	EACH	22.24	6	6	5.12
PLDB182606PP	18" x 26" x 6"	EACH	31.99	6	6	10.16
PLDBC1826PP	Cover Fits 18" x 26"	EACH	17.00	6	6	2.12

## BEVERAGE DISPENSER CONTAINER

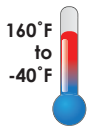

POLYPROPYLENE



PLFA006  
Leak-proof faucet



Liquid Measurements

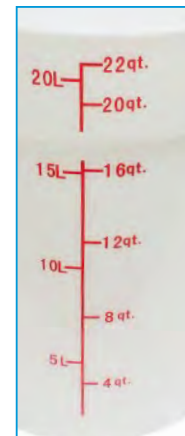

ITEM	DESCRIPTION	U/M	WEIGHT GROSS lbs	INNER PACK	MASTER PACK	CU. FT.
PLBD006PP	6 Gallon Beverage Dispenser With Faucet, 12 $\frac{1}{2}$ " Diameter x 14 $\frac{1}{8}$ " Height	EACH	9.04	4	4	6.85
PLFA006	Faucet For PLBD006PP, 3 $\frac{1}{2}$ " x 1 $\frac{1}{4}$ " x 2 $\frac{1}{8}$ "	EACH	3.22	1	40	0.22





## SHELF INGREDIENT BIN

Stackable. Clear flip top lid. Scoop included with build-in holder.



PP POLYPROPYLENE



PLIB002S



PLIB005S



PLIB010S

ITEM	DESCRIPTION	U/M	WEIGHT GROSS lbs	INNER PACK	MASTER PACK	CU. FT.
PLIB002S	2 Gallon/ 40 Cup, 11 <sup>3</sup> / <sub>4</sub> " x 14 <sup>1</sup> / <sub>2</sub> " x 8 <sup>5</sup> / <sub>8</sub> "	EACH	3.97	1	1	1.06
PLIB005S	5 Gallon/ 80 Cup, 11 <sup>3</sup> / <sub>8</sub> " x 23 <sup>3</sup> / <sub>8</sub> " x 17"	EACH	11.13	1	1	3.18
PLIB010S	10 Gallon/ 150 Cup, 19 <sup>1</sup> / <sub>4</sub> " x 23 <sup>3</sup> / <sub>8</sub> " x 17"	EACH	17.06	1	1	4.94

## INGREDIENT BIN

Two 3" regular casters and two 3" locking casters. Clear sliding lid. Scoop included with build-in hook.



• 21 gal • Holds 160 lbs of sugar or 126 lbs of flour

• 27 gal • Holds 197 lbs of sugar or 154 lbs of flour



PLIB021C



PLIB027C

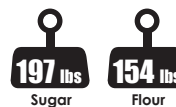
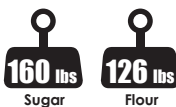

ITEM	DESCRIPTION	U/M	WEIGHT GROSS lbs	INNER PACK	MASTER PACK	CU. FT.
PLIB021C	21 Gallon, 13" x 29 <sup>1</sup> / <sub>4</sub> " x 28", w/Casters and Scoop, S/170,F/139	EACH	27.08	1	1	6.11
PLIB027C	27 Gallon, 16 <sup>1</sup> / <sub>2</sub> " x 29 <sup>1</sup> / <sub>2</sub> " x 28", w/Casters and Scoop, S/207, F/150	EACH	29.95	1	1	7.33
PLCB3150	3" Caster For PLIB021C & PLIB027C	EACH	9.04	4	4	6.85
PLCB3150B	3" Caster With Brake For PLIB021C & CPLIB027C	EACH	9.04	4	4	6.85



PLCB001 ~ PLCB004



PLCB005



PLCB006



PLCB008



PLCB007



PLRCB001, PLRCB002



PLCB011 ~ PLCB017  
(Heavy Duty)



## CUTTING BOARD

Non-skid surface.



Made in Taiwan



PLCB004, PLCB005 & PLCB006 are NSF listed.



ITEM	DESCRIPTION	U/M	WEIGHT GROSS lbs	INNER PACK	MASTER PACK	CU. FT.
<b>Square</b>						
PLCB001	15" x 9" x 1/2"	EACH	35.49	20	20	0.86
PLCB002	16" x 10" x 1/2"	EACH	43.43	20	20	1.00
PLCB003	17" x 11" x 1/2"	EACH	51.36	20	20	1.20
PLCB004	18" x 12" x 1/2"	EACH	58.42	20	20	1.40
PLCB005	20" x 15" x 1/2"	EACH	49.38	10	10	1.20
PLCB006	24" x 18" x 1/2"	EACH	72.97	10	10	1.60
PLCB008	6" x 10" x 3/8"	EACH	18.30	20	20	0.43
<b>Ping Pong</b>						
PLCB007	13 7/8" x 6 7/8" x 3/8" with Handle	EACH	22.71	20	20	0.65

## ROUND BOARD - HIGH DENSITY POLYETHYLENE



Made in Taiwan



ITEM	DESCRIPTION	U/M	WEIGHT GROSS lbs	INNER PACK	MASTER PACK	CU. FT.
PLRCB001	14" x 1"	EACH	54.01	10	10	1.37
PLRCB002	14" x 1/2"	EACH	47.40	20	20	1.20

## HEAVY DUTY CUTTING BOARD - HIGH DENSITY POLYETHYLENE



Made in Taiwan



ITEM	DESCRIPTION	U/M	WEIGHT GROSS lbs	INNER PACK	MASTER PACK	CU. FT.
PLCB011	12" x 18" x 3/4"	EACH	52.25	10	10	1.30
PLCB012	15" x 20" x 3/4"	EACH	36.38	5	5	0.70
PLCB013	18" x 24" x 3/4"	EACH	53.46	5	5	1.00
PLCB014	12" x 18" x 1 1/8"	EACH	43.76	5	5	0.98
PLCB015	15" x 20" x 1 1/8"	EACH	48.50	4	4	1.12
PLCB016	18" x 24" x 1 1/8"	EACH	52.23	3	3	1.27
PLCB017	20" x 30" x 1 1/8"	EACH	48.46	2	2	1.31

Made in Taiwan

Made in Taiwan

Made in Taiwan

Made in Taiwan

## POLYETHYLENE COLOR CUTTING BOARDS - HDPE



Made in Taiwan



ITEM	DESCRIPTION	U/M	WEIGHT GROSS lbs	INNER PACK	MASTER PACK	CU. FT.
<b>18" x 12"</b>						
PLCB181205BR	18" x 12" x 1/2" Brown	EACH	22.27	6	6	0.42
PLCB181205BU	18" x 12" x 1/2" Blue	EACH	22.27	6	6	0.42
PLCB181205GR	18" x 12" x 1/2" Green	EACH	22.27	6	6	0.42
PLCB181205RD	18" x 12" x 1/2" Red	EACH	22.27	6	6	0.42
PLCB181205WH	18" x 12" x 1/2" White	EACH	22.27	6	6	0.42
PLCB181205YW	18" x 12" x 1/2" Yellow	EACH	22.27	6	6	0.42
PLCB181205PP	18" x 12" x 1/2" Purple	EACH	22.27	6	6	0.42
<b>20" x 15"</b>						
PLCB201505BR	20" x 15" x 1/2" Brown	EACH	30.86	6	6	0.62
PLCB201505BU	20" x 15" x 1/2" Blue	EACH	30.86	6	6	0.62
PLCB201505GR	20" x 15" x 1/2" Green	EACH	30.86	6	6	0.62
PLCB201505RD	20" x 15" x 1/2" Red	EACH	30.86	6	6	0.62
PLCB201505WH	20" x 15" x 1/2" White	EACH	30.86	6	6	0.62
PLCB201505YW	20" x 15" x 1/2" Yellow	EACH	30.86	6	6	0.62
PLCB201505PP	20" x 15" x 1/2" Purple	EACH	30.86	6	6	0.62
<b>24" x 18"</b>						
PLCB241805BR	24" x 18" x 1/2" Brown	EACH	44.75	6	6	0.86
PLCB241805BU	24" x 18" x 1/2" Blue	EACH	44.75	6	6	0.86
PLCB241805GR	24" x 18" x 1/2" Green	EACH	44.75	6	6	0.86
PLCB241805RD	24" x 18" x 1/2" Red	EACH	44.75	6	6	0.86
PLCB241805WH	24" x 18" x 1/2" White	EACH	44.75	6	6	0.86
PLCB241805YW	24" x 18" x 1/2" Yellow	EACH	44.75	6	6	0.86
PLCB241805PP	24" x 18" x 1/2" Purple	EACH	44.75	6	6	0.86

BR - Brown: Cooked Meat  
 BU - Blue: Seafood  
 GR - Green: Vegetable  
 RD - Red: Raw Meat  
 WH - White: All Purpose  
 YW - Yellow: Poultry  
 PP - Allergen Free



PLCB181205BR ~ PLCB181205PP

## POLYETHYLENE COLOR CUTTING BOARD SET - HDPE

Set of 6 Assorted Colors, one each Blue, Brown, Green, Red, White and Yellow



Made in Taiwan



ITEM	DESCRIPTION	U/M	WEIGHT GROSS lbs	INNER PACK	MASTER PACK	CU. FT.
PLCB181205MX	18" x 12" x 1/2" 6 Color Set	SET	22.27	1	1	0.42
PLCB201505MX	20" x 15" x 1/2" 6 Color Set	SET	30.86	1	1	0.62
PLCB241805MX	24" x 18" x 1/2" 6 Color Set	SET	44.75	1	1	0.86

CUTTING BOARD RACK & BRUSH



PLCBBR006



Color matching cutting boards available



PLCBB02BR



PLCBB02BU



PLCBB02GR



PLCBB02RD



PLCBB02WH



PLCBB02YW

ITEM	DESCRIPTION	U/M	WEIGHT GROSS lbs	INNER PACK	MASTER PACK	CU. FT.
<b>Board Rack Powder coated black wire with hooks</b>						
PLCBBR006	12" x 9 1/4" x 10 1/4" H	EACH	23.37	6	6	1.91
<b>Brushes 6" x 2 1/2" x 2" H</b>						
PLCBB02BR	Brown	EACH	23.10	12	72	1.65
PLCBB02BU	Blue	EACH	23.10	12	72	1.65
PLCBB02GR	Green	EACH	23.10	12	72	1.65
PLCBB02RD	Red	EACH	23.10	12	72	1.65
PLCBB02WH	White	EACH	23.10	12	72	1.65
PLCBB02YW	Yellow	EACH	23.10	12	72	1.65

Made in Taiwan

PIZZA RACK

Chrome plated wire pizza pan rack.

ITEM	DESCRIPTION	U/M	WEIGHT GROSS lbs	INNER PACK	MASTER PACK	CU. FT.
CRPT1015	15 Tier Pizza Pan Rack, Welded, Chrome 12" x 12" x 27 3/4"	EACH	13.84	1	2	2.56

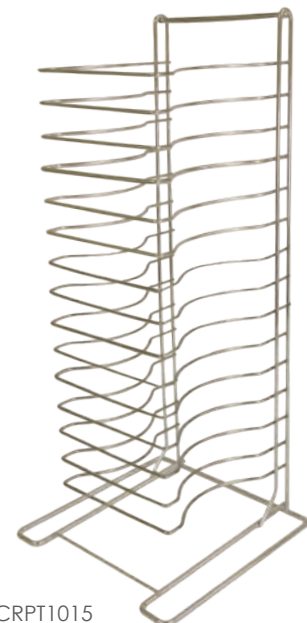

CRPT1015

**EGG SLICER**

Piano wire cutters finely slice hard-boiled eggs.



ITEM	DESCRIPTION	U/M	WEIGHT GROSS lbs	INNER PACK	MASTER PACK	CU. FT.
ALES-005C	5¼" x 3⅝" x 1" Square Shape	EACH	34.28	12	144	2.03
ALES005R	4¾" x 4¼" x 1⅞" Round Shape	EACH	51.80	12	144	2.90



ALES-005C



ALES005R

**CHEESE CUTTER**

ITEM	DESCRIPTION	U/M	WEIGHT GROSS lbs	INNER PACK	MASTER PACK	CU. FT.
SLKCC005	5 ¼" x 5" x ½" with Zinc Alloy Handle	EACH	18.30	1	36	0.42



SLKCC005

**MANUAL PASTA MACHINE**

Ideal for making fine strands of fresh pasta. Iron body with handle is detachable for cleaning. Medium (6 mm) and fine (2 mm) noodle width roller options included. Comes with table clamp.

ITEM	DESCRIPTION	U/M	WEIGHT GROSS lbs	INNER PACK	MASTER PACK	CU. FT.
GN001	8" x 8" x 5½"	EACH	44.10	1	6	1.63

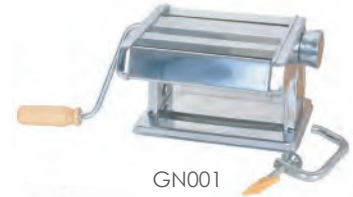

GN001

**MIXING PADDLE**

A sturdy tool for dough mixing or cooking in large stock pot.

ITEM	DESCRIPTION	U/M	WEIGHT GROSS	INNER PACK	MASTER PACK	CU. FT.
<b>Stainless Steel</b>						
SLMP024	24", 8⅞" x 4½", 15" Length Handle	EACH	26.46	6	12	1.19
SLMP030	30", 8 ⅞" x 4½", 10⅞" Length Handle	EACH	28.66	6	12	1.27
SLMP036	36", 9" x 4½", 20⅞" Length Handle	EACH	30.86	6	12	1.36
SLMP042	42", 9" x 4½", 33" Length Handle	EACH	33.07	6	12	1.60
SLMP048	48", 9" x 4½", 39" Length Handle	EACH	35.27	6	12	1.81
SLMP054	54", 9" x 4½", 45" Length Handle	EACH	37.48	6	12	2.05
SLMP060	60", 9" x 4½", 51⅞" Length Handle	EACH	39.68	6	12	2.26
<b>Wood</b>						
WDTHMP018	18", 7⅞" x 3⅞", 10⅞" Length Handle	EACH	12.13	1	24	0.55
WDTHMP020	20", 7⅞" x 3⅞", 12⅞" Length Handle	EACH	18.70	1	24	0.62
WDTHMP024	24", 7⅞" x 3⅞", 16⅞" Length Handle	EACH	16.98	1	24	0.72
WDTHMP030	30", 7⅞" x 3⅞", 22⅞" Length Handle	EACH	22.05	1	24	0.91
WDTHMP036	36", 7⅞" x 3⅞", 28⅞" Length Handle	EACH	14.33	1	12	0.59
WDTHMP042	42", 7⅞" x 3⅞", 34⅞" Length Handle	EACH	16.53	1	12	0.69
WDTHMP048	48", 7⅞" x 3⅞", 40⅞" Length Handle	EACH	18.34	1	12	0.78
WDTHMP054	54", 7⅞" x 3⅞", 46⅞" Length Handle	EACH	21.56	1	12	0.93
WDTHMP060	60", 7⅞" x 3⅞", 52⅞" Length Handle	EACH	22.44	1	12	1.03



SLMP030



WDTHMP030



CRHH876

### HAM HOLDER

Chrome plated wire ham holder.

ITEM	DESCRIPTION	U/M	WEIGHT GROSS lbs	INNER PACK	MASTER PACK	CU. FT.
CRHH876	Ham Holder 8½" x 7¼" x 6"	EACH	39.57	24	24	2.80



CRDB1218

### DONUT BASKET

Chrome plated basket holds donuts while cooling.

ITEM	DESCRIPTION	U/M	WEIGHT GROSS lbs	INNER PACK	MASTER PACK	CU. FT.
CRDB1218	12" x 18" x 2"	EACH	42.59	24	24	2.23
CRDB1626	16" x 26" x 2"	EACH	36.58	12	12	2.16



CRDB1626

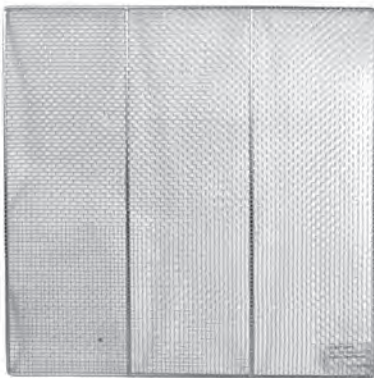

SLRACK0019

### SQUARE DONUT SCREEN

Catches icing and glaze while cooling or decorating donuts.



ITEM	DESCRIPTION	U/M	WEIGHT GROSS lbs	INNER PACK	MASTER PACK	CU. FT.
SLRACK0019	19" x 19" x ¼"	EACH	33.07	12	12	0.83
SLRACK0023	23" x 23" x ¼"	EACH	19.07	6	6	0.88



SLRACK1734

### ROUND STEAM RACK

Holds food in place while in steamer. Legs allow for room and stacking. Grills allow air to circulate. Nickel plated.



ITEM	DESCRIPTION	U/M	WEIGHT GROSS lbs	INNER PACK	MASTER PACK	CU. FT.
SLRACK1050	10½" Diameter x 1½" Height	EACH	20.28	30	30	0.87
SLRACK1234	12 ¾" Diameter x 1½" Height	EACH	22.05	30	30	1.60
SLRACK1434	14 ¾" Diameter x 1½" Height	EACH	41.89	30	30	2.09
SLRACK1734	17 ¾" Diameter x 1½" Height	EACH	46.99	30	30	3.21

### FRYER SCREEN

Easy to clean and durable nickel plated screen.



ITEM	DESCRIPTION	U/M	WEIGHT GROSS lbs	INNER PACK	MASTER PACK	CU. FT.
SLRACK1114	11 <sup>3</sup> / <sub>8</sub> " x 14 <sup>5</sup> / <sub>8</sub> " Designed to fit Fryer: Frymaster: GF-14SD and MJ-35SD	EACH	46.30	12	48	1.24
SLRACK1313	13 <sup>1</sup> / <sub>2</sub> " x 13 <sup>1</sup> / <sub>2</sub> " Fits Fryer: Imperial: IFS-40 and American Range: AF-45	EACH	42.99	12	48	1.37

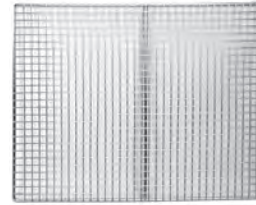

SLRACK1114

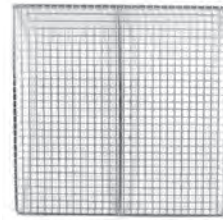

SLRACK1313

### ICING/COOLING RACK

Strong chrome-plated wire with built-in feet. Use for decorating and cooling pastries.

ITEM	DESCRIPTION	U/M	WEIGHT GROSS lbs	INNER PACK	MASTER PACK	CU. FT.
SLRACK1624	16" x 23 <sup>3</sup> / <sub>4</sub> "	EACH	30.01	12	12	1.05
SLRACK1725	17" x 25"	EACH	28.26	12	12	1.64
SLWG1216	12" x 16 <sup>1</sup> / <sub>8</sub> "	EACH	64.68	12	48	2.46
SLWG1622	16" x 22"	EACH	40.79	12	24	2.18
SLWG1624	16" x 23 <sup>3</sup> / <sub>4</sub> "	EACH	57.32	12	24	2.34



SLWG1216



SLWG1622



SLWG1624

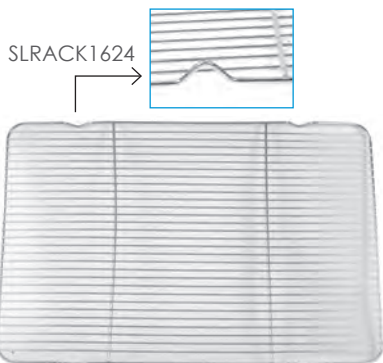

SLRACK1624



SLRACK1725

### CHROME PLATED WIRE GRATE

Withstands heat and corrosion. Metal grate with stable feet allows breads, cakes, and cookies to cool.

ITEM	DESCRIPTION	U/M	WEIGHT GROSS lbs	INNER PACK	MASTER PACK	CU. FT.
SLWG001	Third Size 5" x 10"	EACH	17.01	50	50	0.66
SLWG002	Half Size 8" x 10"	EACH	23.15	50	50	0.86
SLWG003	Full Size 18" x 10"	EACH	41.09	50	50	1.89



SLWG002



PLMC008CL



PLMC016CL ~ PLMC128CL



SCSL001 ~ SCSL008



SCSL103, SCSL104



TIM-60



CLRC001

## POLYCARBONATE MEASURING CUP

With both U.S. and metric measurements.



ITEM	DESCRIPTION	U/M	WEIGHT GROSS lbs	INNER PACK	MASTER PACK	CU. FT.
PLMC008CL	1 cup/ 0.25L Polycarbonate Measuring Cup	EACH	6.94	12	48	0.99
PLMC016CL	1 pint/0.5L Polycarbonate Measuring Cup	EACH	14.31	12	48	2.78
PLMC032CL	1 qt/ 1L Polycarbonate Measuring Cup	EACH	11.09	12	24	2.59
PLMC064CL	2 qt/ 2L Polycarbonate Measuring Cup	EACH	9.63	6	12	2.62
PLMC128CL	4 qt/ 4L Polycarbonate Measuring Cup	EACH	16.69	4	12	5.01

## SCALE

Stainless steel platform with easy to clean enamel finish.

ITEM	DESCRIPTION	U/M	WEIGHT GROSS lbs	INNER PACK	MASTER PACK	CU. FT.
SCSL001	2 lb	EACH	30.80	1	6	3.20
SCSL002	5 lb	EACH	30.80	1	6	3.21
SCSL003	11 lb	EACH	30.80	1	4	3.22
SCSL004	22 lb	EACH	30.80	1	4	3.29
SCSL005	48 lb	EACH	30.80	1	4	3.26
SCSL006	70 lb	EACH	37.40	1	2	3.03
SCSL007	100 lb	EACH	37.40	1	2	3.06
SCSL008	200 lb	EACH	47.30	1	2	4.62

## CHINESE CATTIS SCALE

Stainless steel bowl platform.

ITEM	DESCRIPTION	U/M	WEIGHT GROSS lbs	INNER PACK	MASTER PACK	CU. FT.
SCSL103	11 lb	EACH	30.80	1	4	3.24
SCSL104	22 lb	EACH	30.80	1	4	3.17

## TIMER

Times up to 60 minutes. Sounds with a long persistent ring.

ITEM	DESCRIPTION	U/M	WEIGHT GROSS lbs	INNER PACK	MASTER PACK	CU. FT.
TIM-60	60 Minute Timer Long Ring	EACH	29.70	12	96	2.62

## RICE CLOTH

Great for insulating heat or lining inner pots.

ITEM	DESCRIPTION	U/M	WEIGHT GROSS lbs	INNER PACK	MASTER PACK	CU. FT.
CLRC001	43½" x 43" x ½" Polyester	EACH	53.57	12	144	4.56



**POCKET THERMOMETER**

Stainless steel case, with pointed stem and bezel. Accurate readings provided on the go. Compact case with pocket clip.



ITEM	DESCRIPTION	U/M	WEIGHT GROSS lbs	INNER PACK	MASTER PACK	CU. FT.
<b>Box</b>						
SLTH160	-40° to 160° F	EACH	28.99	12	432	2.67
SLTH550	50° to 550° F	EACH	28.99	12	432	2.67
<b>Card</b>						
SLTH160C	-40° to 160° F	EACH	16.01	12	192	3.14
SLTH220C	0° to 220° F	EACH	16.01	12	192	3.14
SLTH550C	50° to 550° F	EACH	16.01	12	192	3.14



SLTH220C



SLTH550C

**DIAL DEEP FRY/CANDY THERMOMETER**

In stainless steel casing.



ITEM	DESCRIPTION	U/M	WEIGHT GROSS lbs	INNER PACK	MASTER PACK	CU. FT.
SLTHD400	100° to 400° F	EACH	16.01	12	96	4.18



SLTHD400

**DIAL MEAT THERMOMETER**



ITEM	DESCRIPTION	U/M	WEIGHT GROSS lbs	INNER PACK	MASTER PACK	CU. FT.
SLTH200	120° to 200° F	EACH	20.00	12	96	5.51



SLTH200

**DIAL THERMOMETER**



ITEM	DESCRIPTION	U/M	WEIGHT GROSS lbs	INNER PACK	MASTER PACK	CU. FT.
SLTHD080	Refrigerator/Freezer -20° to 80° F	EACH	22.00	12	144	2.40
SLTHD550	Oven 150° to 550° F	EACH	22.00	12	144	2.40



SLTHD080



SLTHD550



SLTH600



SLTHL080



SLTHL400



WDGB012



SLGB013



SLKR012

### LIQUID OVEN THERMOMETER

Stainless steel frame features a cover which doubles as a stand. Mercury-filled glass thermometer, with accuracy of +/- 1 degree.

ITEM	DESCRIPTION	U/M	WEIGHT GROSS lbs	INNER PACK	MASTER PACK	CU. FT.
SLTH600	100° to 600° F	EACH	30.00	12	144	4.12

### HORIZONTAL LIQUID SCALE THERMOMETER

Stainless steel casing will not rust in freezer or refrigerator. Dual scale for various readings (Fahrenheit and Celsius). Positions horizontally, either hanging or standing.



ITEM	DESCRIPTION	U/M	WEIGHT GROSS lbs	INNER PACK	MASTER PACK	CU. FT.
SLTHL080	-40° to 80° F	EACH	35.01	12	360	4.13

### LIQUID DEEP FRY CANDY THERMOMETER

Heat-resistant handle on stainless steel body. Dual scale readings of Fahrenheit and Celsius, with accuracy of +/- 1 degree.

ITEM	DESCRIPTION	U/M	WEIGHT GROSS lbs	INNER PACK	MASTER PACK	CU. FT.
SLTHL400	100° to 400° F	EACH	44.00	12	96	3.56

### MAGNETIC BAR WITH WOODEN BASE

Wooden bar with two magnetic strips for a firm hold.

ITEM	DESCRIPTION	U/M	WEIGHT GROSS lbs	INNER PACK	MASTER PACK	CU. FT.
WDGB012	12" x 2" x 1"	EACH	46.30	1	36	0.70
WDGB018	18" x 2" x 1"	EACH	47.40	1	24	0.68
WDGB024	24" x 2" x 1"	EACH	62.17	1	24	0.89

### MAGNETIC BAR WITH HOOKS

Plastic bar with two magnetic strips and optional hanging hooks for a firm hold.

ITEM	DESCRIPTION	U/M	WEIGHT GROSS lbs	INNER PACK	MASTER PACK	CU. FT.
SLGB013	13" x 1½" x 1"	EACH	38.94	1	36	0.73
SLGB018	18" x 1½" x 1"	EACH	56.10	1	36	0.94
SLGB024	24" x 1½" x 1"	EACH	50.71	1	24	0.81

### KNIFE RACK

Capacity for up to 5 knives, 2 cleavers and 2 butcher steels. Mountable on walls, counters, or tables.



ITEM	DESCRIPTION	U/M	WEIGHT GROSS lbs	INNER PACK	MASTER PACK	CU. FT.
SLKR012	13" x 12" x 2½"	EACH	24.25	1	12	3.84

**NYLON PASTRY BRUSH**

Sterilized nylon bristles with contoured handle. Bound by brown plastic ferrule.



ITEM	DESCRIPTION	U/M	WEIGHT GROSS lbs	INNER PACK	MASTER PACK	CU. FT.
WDPB001N	1" Flat - 8¼" x 1" x ½"	EACH	21.03	12	240	1.49
WDPB002N	1½" Flat - 8¾" x 1¾" x ½"	EACH	22.05	12	240	1.75
WDPB003N	2" Flat - 8½" x 2" x ½"	EACH	30.86	12	240	2.31
WDPB004N	3" Flat - 8¾" x 3" x ⅝"	EACH	51.10	12	240	3.77
WDPB005N	4" Flat - 9⅔" x 4" x ⅔"	EACH	63.14	12	240	5.10
WDPB006N	1" Round - 12⅞" x 1" x ½"	EACH	36.38	12	240	3.97

**BOAR PASTRY BRUSH**

Sterilized and bleached boar bristle brush. Firmly embedded in epoxy to withstand heavy use. Ideal for basting over grills, griddles and ovens, where heat is a factor.



ITEM	DESCRIPTION	U/M	WEIGHT GROSS lbs	INNER PACK	MASTER PACK	CU. FT.
WDPB001	1" Flat - 8¼" x 1" x ½"	EACH	21.03	12	240	1.49
WDPB002	1½" Flat - 8¾" x 1¾" x ½"	EACH	22.05	12	240	1.75
WDPB003	2" Flat - 8½" x 2" x ½"	EACH	30.86	12	240	2.31
WDPB004	3" Flat - 8¾" x 3" x ⅝"	EACH	51.10	12	240	3.77
WDPB005	4" Flat - 9⅔" x 4" x ⅔"	EACH	63.14	12	240	5.10
WDPB006	1" Round - 12⅞" x 1" x ½"	EACH	36.38	12	240	3.97

# GAS & ELECTRIC



GAS & ELECTRIC PRODUCTS

## STAINLESS STEEL SOUP WARMER

Keep soup at the proper temperature ready to serve. Epoxy coated aluminum body made to match any kitchen decor. Lid attached with hinges for quick serving. Adjustable temperature control. Stainless collar.



SEJ35000C



**Voltage:** 110V-120V  
**Max:** 185°F  
**Wattage:** 400W



Gift boxed

ITEM	DESCRIPTION	U/M	WEIGHT GROSS lbs	INNER PACK	MASTER PACK	CU. FT.
SEJ35000C	10 qt - Black - 13½" Diameter x 14¾" Height	EACH	12.39	1	1	1.60
SEJ12007-2	Inner Pot for SEJ35000C					



## STAINLESS STEEL SOUP/ FOOD WARMER

- Stainless steel case and interior lining
- Thermostatic heat control with 6 settings
- Inset and hinged cover included



SEJ38000C



**Voltage:** 120V  
**Max:** 185° F  
**Wattage:** 800W



Gift boxed

ITEM	DESCRIPTION	U/M	WEIGHT GROSS lbs	INNER PACK	MASTER PACK	CU. FT.
SEJ38000C	10.5 qt - 12¾" Diameter x 13" Height	EACH	14.26	1	1	1.60
SEJ12007-3	Inner Pot for SEJ38000C					

**COUNTERTOP FOOD WARMER**

- Heavy duty stainless steel body.
- Thermostatically controlled heating element for longer life.
- Water resistant on/off switch cover.
- Standard 20" x 12" inside well opening accepts most popular steamer pans.
- Includes: 59" power cord & 3-prong grounded plug.



Gift boxed



Voltage: 120V  
Max: 194° F  
Wattage: 1200W



SEJ81000C



Shown with SLIP003 & SLIP004 Inset Pans and Adaptor plate.  
Sold separately, page 236 & 237.

ITEM	DESCRIPTION	U/M	WEIGHT GROSS lbs	INNER PACK	MASTER PACK	CU. FT.
SEJ81000C	3.5 qt - 24" x 14 1/2" x 9" Well Capacity - Brushed S/S Finish with Ventilation Slots	EACH	18.00	1	1	2.49

**COMMERCIAL ELECTRIC INDUCTION COOKER**

Electric Overheating Protection  
Touch Control Pad  
LED Display Timer: 0-180 minutes  
1-10 Power Levels  
1-10 Temperature Setting

Temperature Range: 140° F to 464° F  
Voltage: 110V-120V. AC / 60Hz  
Wattage: 800W



Gift boxed



SEJ45000C

German Schott™ Ceramnic Glass  
Stainless Body

ITEM	DESCRIPTION	U/M	WEIGHT GROSS lbs	INNER PACK	MASTER PACK	CU. FT.
SEJ45000C	1800W, 120V, 60HZ, 1800W 16 1/2" x 12 3/8" x 3 7/8"	EACH	28.70	1	2	2.68

**SEALING MACHINE**

Electrical appliance with adjustable temperature dial for different bag materials and thickness.



ITEM	DESCRIPTION	U/M	WEIGHT GROSS lbs	INNER PACK	MASTER PACK	CU. FT.
IRTISH200	8"	EACH	59.52	1	10	2.50
IRTISH300	11"	EACH	55.12	1	6	2.60
IRTISH400	15 1/4"	EACH	46.30	1	4	2.20



IRTISH200





RER55ASL



RER55ASN

### RINNAI GAS COOKER

Prepare rice in this appliance without worries of over cooking. Makes 100 bowls of rice in just 22 minutes (270 servings at 3 oz each). Propane or Natural Gas with piezo pilot ignition. Reduces hazards with Flame Failure Safety Device. Design and safety rated.



ITEM	DESCRIPTION	U/M	WEIGHT GROSS lbs	INNER PACK	MASTER PACK	CU. FT.
RER55ASL	55 cups Propane 23" x 18½" x 17¾"	EACH	45.00	1	1	5.36
RER55ASN	55 cups Natural Gas 23" x 18½" x 17¾"	EACH	45.00	1	1	5.36

Gas Input Rating: 35,000 BTU/h (Natural Gas),  
34,000 BTU/h (Propane Gas)  
Gas Connection: ½" NPT Female  
Safety Device: Flame Failure Safety Device

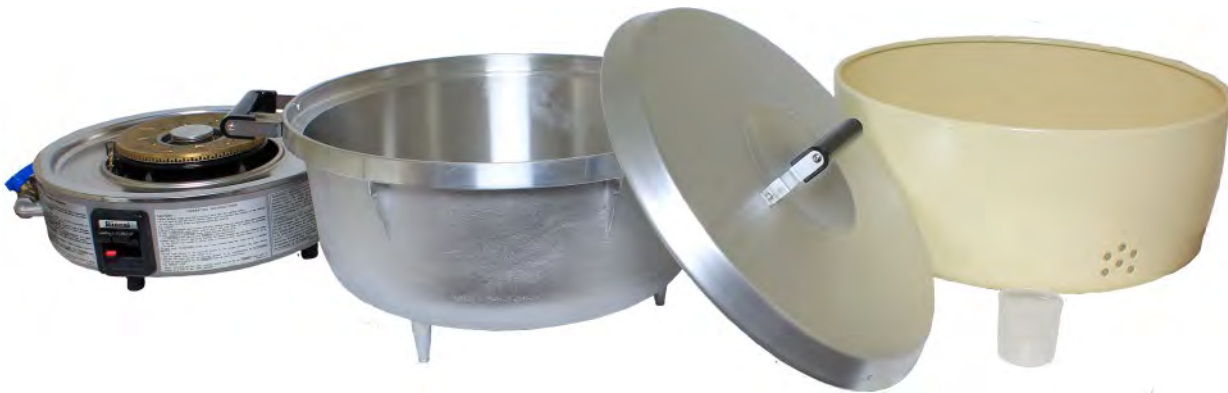

Power switch



Gas connector



Inner pot



### ELECTRIC RICE COOKER & WARMER

Makes 30 cups of hassle-free rice. Cooks and keeps warm automatically. Keep rice warm for up to 3 hours. Inner pot is available with a non-stick finish. Cook Time = 28 to 32 minutes for 60 bowls of cooked rice.



ITEM	DESCRIPTION	U/M	WEIGHT GROSS lbs	INNER PACK	MASTER PACK	CU. FT.
SEJ50000	30 cups - 16¼" x 14½" x 14"	EACH	20.00	1	1	2.06
SEJ50000T	30 cups Nonslick Teflon - 16¼" x 14½" x 14"	EACH	20.00	1	1	2.06

**PARTS**

SEJB001	Inner Pot for SEJ50000 - 14⅝" x 14½" x 7"	EACH				
SEJB001T	Inner Pot for SEJ50000T - 14⅝" x 14½" x 7"	EACH				
SEJB002	Lid for SEJ5000/ SEJ5000T	EACH				



SEJ50000, SEJ50000T  
Voltage: 110V-120V. AC / 60Hz  
Wattage: 1780W

### ELECTRIC RICE COOKER

Stainless steel exterior with digital pad. Available in 30 cups/60 serving bowls capacity and 33 cups/66 serving bowls capacity. Comes with rice spoon, measuring cup and stick-free silicone pad.



ITEM	DESCRIPTION	U/M	WEIGHT GROSS lbs	INNER PACK	MASTER PACK	CU. FT.
SEJ3201	30 cups - 14⅝" Diameter x 14⅝" height	EACH	22.49	1	1	2.46
SEJ60000	33 cups - 18⅝" x 15" x 13¾"	EACH	24.47	1	1	2.89

**PARTS**

ITEM	DESCRIPTION	U/M	
1 SEJ64020	Inner Pot for SEJ3201- 14" Diameter x 7⅞" height Non-Stick Aluminum.	EACH	Made in Korea
2 SEJ6012	Inner Pot for SEJ60000 13⅞" Diameter x 8¼" height Non-Stick Teflon Coating Aluminum.	EACH	Made in Taiwan



SEJ3201

Voltage: 110V-120V. AC / 60Hz  
Cooking Wattage: 1460W  
Warming Wattage: 100W



SEJ60000

Cook Time = 25 min  
Voltage: 110V-120V. AC / 60Hz  
Cooking Wattage: 1780W  
Warming Wattage: 100W  
Cooking = 302° F  
Warming = 158° F

## ELECTRIC RICE WARMER

Mirror finished stainless steel lid and base hinged on wood grain accented body. Keeps rice warm after it is cooked for an additional 12 hours. Serves 30-50 cups. Available in wood grain & mirror polished stainless steel finish.



Made in Taiwan

Voltage: 110V-120V, AC / 60Hz  
Wattage: 100W



SEJ18000



SEJ21000



Gift boxed



SEJ20000



SEJ22000



Gift boxed

ITEM	DESCRIPTION	U/M	WEIGHT GROSS lbs	INNER PACK	MASTER PACK	CU. FT.
<b>Woodgrain</b>						
SEJ18000	Wood Grain, 30 cups 15¾" Diameter x 11½" Height	EACH	18.00	1	1	2.48
SEJ21000	Wood Grain, 50 cups 15¾" Diameter x 15" Height	EACH	20.00	1	1	3.00
<b>Stainless Steel</b>						
SEJ22000	Stainless Steel, 50 cups 15¾" Diameter x 15" Height	EACH	20.00	1	1	3.00
SEJ20000	Stainless Steel, 30 cups 15¾" Diameter x 11½" Height	EACH	18.00	1	1	2.48



## PARTS

ITEM	DESCRIPTION	U/M
1	SEJ001 Inner Lid for SEJ21000/ SEJ22000	EACH
2	SEJ002 Bushing for SEJ21000/ SEJ22000	EACH
3	SEJ003 Inner Pan Handle	EACH
4	SEJ004 50 Cups Rice Warmer Inner Pot	EACH
5	SEJ004A 30 Cups Rice Warmer Inner Pot	EACH
6	SEJ008 Latch Hook	EACH
7	SEJ009 Radiator Disk	EACH
8	SEJ010 ¾" length Lid Supporting Pin	EACH
9	SEJ011 Upper Lid	EACH
10	SEJ012 Shoulder	EACH
11	SEJ013 1.8 meter length Power Cord	EACH
12	SEJ014 Orange Light "On" While Operated	EACH

Made in Taiwan

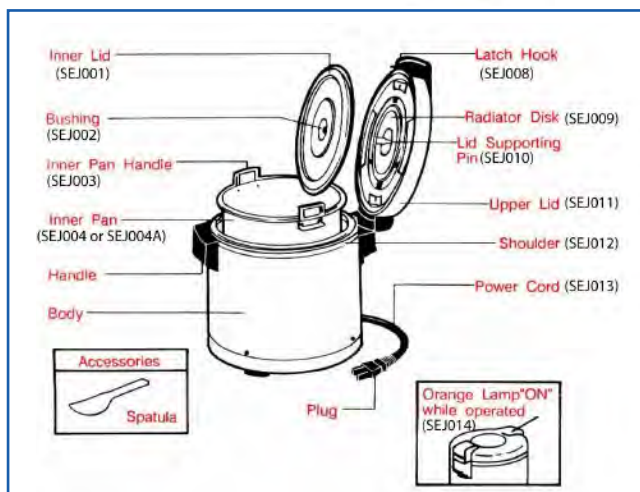



## HIGH FREESTANDING DUAL HEAT LAMP

The heat lamp is intended for use in food preparation and storage so that it can heat evenly. The adjustable lamp post allows the user to manipulate the height making it easier to slide the food item underneath the lamp and serve as needed. The heat lamp set is constructed of durable aluminum, includes two shatter-proof 250-watt food safe bulb.



Voltage: 110V-120V, AC / 60Hz  
Wattage: 500w  
5.42 FT Long Cord



SEJ92001R  
250-Watt



SEJ92001C  
250-Watt  
( Two clear heat bulbs included )



SEJ92000



ITEM	DESCRIPTION	U/M	WEIGHT GROSS lbs	INNER PACK	MASTER PACK	CU. FT.
SEJ92000	23" Heat Lamp - 19 $\frac{3}{4}$ " x 13 $\frac{5}{8}$ " x 23" Adj. Arm 23-30"	SET	5.72	1	1	1.10
SEJ92001C	Clear Bulb for SEJ92000 - 5" Diameter x 6 $\frac{1}{2}$ " length	EACH	7.94	1	24	1.68
SEJ92001R	Red Bulb for SEJ92000 5" Diameter x 6 $\frac{1}{2}$ " length	EACH	7.94	1	24	1.68

## SINGLE AND DOUBLE STOVES

Small and compact for limited space. Single stove features easily adjustable heat dial. Double stove features two independently adjustable heat dials. Smooth and easy to clean surface. **Propane only.**

**\*\* No Warranty \*\***

**\*\* Includes Low Pressure Regulator \*\***



SLST001  
16,500 BTU/H



SLST002  
29,700 BTU/H

ITEM	DESCRIPTION	U/M	WEIGHT GROSS lbs	INNER PACK	MASTER PACK	CU. FT.
SLST001	Single Stove, 5kw/hr	EACH	9.02	1	1	0.63
SLST002	Double Stove, 9kw/hr	EACH	16.06	1	1	1.52

Made in Taiwan

# JANITORIAL



JANITORIAL

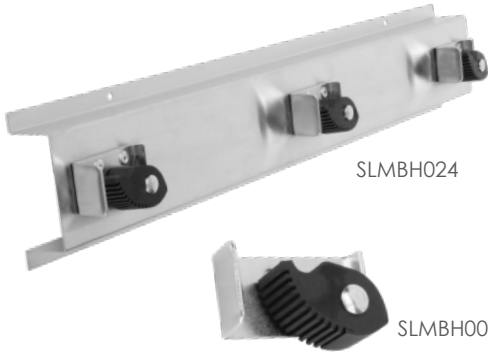

## MOP HOLDER: WALL-MOUNT STYLE

ITEM	DESCRIPTION	U/M	WEIGHT GROSS lbs	INNER PACK	MASTER PACK	CU. FT.
SLMBH003	2½" x 2", x 1½" Nickel Plated	EACH	44.40	12	240	1.10
SLMBH024	24" x 4" x 2½" 18/8 Stainless Steel	EACH	17.60	1	8	0.94

18/8 **SS** STAINLESS STEEL



SLSD040H

Made in Taiwan



SLSD040V

## STAINLESS STEEL SOAP DISPENSER

ITEM	DESCRIPTION	U/M	WEIGHT GROSS lbs	INNER PACK	MASTER PACK	CU. FT.
SLSD040H	40 oz Horizontal Rectangular 8¼" x 47/8" x 5¼"	EACH	46.20	1	24	3.86
	18/8 <b>SS</b> STAINLESS STEEL					
SLSD040V	40 oz Vertical Rectangular 8¼" x 5¼" x 47/8"	EACH	46.20	1	24	3.86
	18/8 <b>SS</b> STAINLESS STEEL					



PLSD377

## PLASTIC SOAP DISPENSER

ITEM	DESCRIPTION	U/M	WEIGHT GROSS lbs	INNER PACK	MASTER PACK	CU. FT.
PLSD377	Anti-Leak Push-Button Soap Dispenser - 32 oz, 8¾" x 3¾" x 9½"	EACH	29.32	1	24	3.32



SLTD101



SLTD102

## TISSUE DISPENSER

ITEM	DESCRIPTION	U/M	WEIGHT GROSS lbs	INNER PACK	MASTER PACK	CU. FT.
SLTD101	Locking Toilet, Single, Chrome Plated 6" x 2¾" x 4½" Fits 4" Diameter Toilet Paper Roll	EACH	31.00	1	42	2.15
SLTD102	Locking Toilet, Single, Chrome Plated 12¼" x 2¾" x 4¾" Fits 4" Diameter Toilet Paper Roll	EACH	30.80	1	21	2.15

**STAINLESS STEEL TOILET PAPER DISPENSER**

ITEM	DESCRIPTION	U/M	WEIGHT GROSS lbs	INNER PACK	MASTER PACK	CU. FT.
SLTD301	Jumbo-Roll Toilet Tissue, 10½" Diameter x 4½"	EACH	39.60	1	12	4.93
SLTD302	Twin Jumbo-Roll Toilet Tissue Dispenser, 20½" x 12½" x 6"	EACH	37.40	1	4	5.00



Key to unlock and open dispenser (included)



SLTD301



SLTD302

**PLASTIC TOILET PAPER DISPENSER**

ITEM	DESCRIPTION	U/M	WEIGHT GROSS lbs	INNER PACK	MASTER PACK	CU. FT.
PLRPD392	12" x 5¼" x 11¾", Center Core 3¼" Diameter, Hold up to one 9" Diameter	EACH	39.60	1	12	4.93
PLRPD396	19" x 5" x 12¼", Center Core 2¾" Diameter, Hold up to two 9" Diameter	EACH	37.40	1	4	5.00



Key to unlock and open dispenser (included)



PLRPD392



PLRPD396

**TOILET SHEET COVER DISPENSER**

ITEM	DESCRIPTION	U/M	WEIGHT GROSS lbs	INNER PACK	MASTER PACK	CU. FT.
SLTSCD500	Toilet Seat Cover Dispenser, 500 Sheets 15½" x 11½" x 2" - Fits 15" x 10¾" Seat Cover	EACH	35.20	1	12	3.22



SLTSCD500

## TOILET SEAT COVER DISPENSER

Toilet seat cover dispenser's curved contemporary design creates the best impression for your restrooms. Dispenses one cover at a time. Fully enclosed.

ITEM	DESCRIPTION	U/M	WEIGHT GROSS lbs	INNER PACK	MASTER PACK	CU. FT.
CRTSCD3812	Half Fold Toilet Seat Cover Dispenser, Chrome, 16" x 11½" x 3"	EACH	28.60	1	12	3.48
PLTSCD3812	Half Fold Toilet Seat Cover Dispenser, White Plastic, 16" x 11½" x 3"	EACH	16.72	1	20	3.55
<b>Toilet Seat Covers</b>						
PATSC050	Half Fold Paper Toilet Seat Covers 250 Sheet/Pack, 20 Pack/Case, 16½" x 14½"	CASE	24.20	1	1	1.38



PATSC050

## PAPER TOWEL DISPENSER

Transparent full-swing replaceable covers provide easy viewing of paper. Covers have key lock.

ITEM	DESCRIPTION	U/M	WEIGHT GROSS lbs	INNER PACK	MASTER PACK	CU. FT.
PLSTD393	Square, 11" x 10½" x 13½" Hold up to 7¼" dia, roll of 8"	EACH	16.28	1	3	3.52
PLPTD394	Center-Pull 9½" x 8½" x 13½" Hold up to 8" dia, roll of 9½"	EACH	23.98	1	6	6.13
PLFTD395	Multi-Fold 11½" x 4¼" x 14¼" Hold up to 10¼" width	EACH	36.08	1	10	6.96



PLSTD393



PLPTD394



PLFTD395



PLSTD393 Open



PLSTD393 Back

## STAINLESS STEEL HOOD FILTER

Easy to clean with detergent and water, also dishwasher safe.



ITEM	DESCRIPTION	U/M	WEIGHT GROSS lbs	INNER PACK	MASTER PACK	CU. FT.
SLHF1620	16" X 20" x 1½"	EACH	23.34	1	6	2.57
SLHF1625	16" X 25" x 1½"	EACH	29.07	1	6	3.19
SLHF2016	20" X 16" x 1½"	EACH	23.56	1	6	2.57
SLHF2020	20" X 20" x 1½"	EACH	27.97	1	6	3.12
SLHF2025	20" X 25" x 1½"	EACH	33.69	1	6	3.92



## DUST PAN & BROOM

Plastic general-purpose dust pan, with flat surface and easy-grip handle. Made to catch dirt residue. Brooms are available in natural coconut and polypropylene bristle.



ITEM	DESCRIPTION	U/M	WEIGHT GROSS lbs	INNER PACK	MASTER PACK	CU. FT.
PLDP002	12" x 13" x 28¾" Dust Pan	DOZEN	11.46	1	1	1.56
PLDP003	12" x 10½" x 42" Broom Set	DOZEN	21.61	1	1	2.02
PLSP001	13½" x 7¾" x 46½" Broom	EACH	79.37	1	100	12.00
PLDP345	13" x 12" x 36¾" Lobby Dust Pan with Windbreak Cover	EACH	23.32	1	10	2.34

Made in Taiwan  
Made in Taiwan  
Made in Taiwan



PLGL001



PLGL004GR



PLWB361W

PLWB361 SET

PLWB361B



PLFL330

PLFCS330  
PLFCS332



PLWFC024

PLWFC027



RYTP351A

### GLOVES

Washable and safe to reuse.

Made in Taiwan

ITEM	DESCRIPTION	U/M	WEIGHT GROSS lbs	INNER PACK	MASTER PACK	CU. FT.
<b>Rubber</b>						
PLGL001	8½" x 13", Regular	DOZEN	92.59	1	30	3.90
PLGL002	8½" x 16", Long	DOZEN	90.39	1	20	3.33
PLGL003	9½" x 16", XL	DOZEN	77.16	1	12	3.50
PLGL004	9" x 16"	DOZEN	55.44	1	10	2.47
<b>Latex</b>						
PLGL004GR	12" x 3¾", Green	PAIR	18.50	12	144	1.02

### MOP HANDLE & MOP BUCKETS W/ WRINGER

Predominantly plastic non-marking caster for reduced touch-up cleaning. Smooth easy-to-clean surfaces. Color coded systems for reduced potential of cross contamination.

ITEM	DESCRIPTION	U/M	WEIGHT GROSS lbs	INNER PACK	MASTER PACK	CU. FT.
PLWB361	36 qt Bucket with Wringer Set, Yellow 19½" x 16" x 24" - Handle 17"	SET	14.39	1	1	2.66
PLWB361B	Bucket 9½" x 16" x 10¾" - w/o Wheel. 4" Wheel	EACH	25.95	1	4	4.60
PLWB361W	Wringer 11" x 9¾" x 14½"	EACH	21.61	1	2	2.68

### POP-UP SAFETY CONE

No assembly required.

ITEM	DESCRIPTION	U/M	WEIGHT GROSS lbs	INNER PACK	MASTER PACK	CU. FT.
PLFCS330	19 ½" w/ Storage Tube	EACH	57.20	1	48	4.49
PLFCS332	31" w/ Storage Tube	EACH	48.28	1	24	4.53
PLFL330	Flashing Light	EACH	7.27	1	48	0.80

\*\* Batteries for PLFL330 Flashing Light are not included.\*\*

### CAUTION SIGN

Two-sided signs.

ITEM	DESCRIPTION	U/M	WEIGHT GROSS lbs	INNER PACK	MASTER PACK	CU. FT.
PLWFC024	Fold-Up 24" x 12"	EACH	17.64	1	10	1.99
PLWFC027	Cone 10¾" x 10¾" x 27"	EACH	28.97	1	10	3.40

### PLUNGER

Plastic material is easy to clean.

ITEM	DESCRIPTION	U/M	WEIGHT GROSS lbs	INNER PACK	MASTER PACK	CU. FT.
RYTP351A	21" Long Wood Handle, 5¾" Diameter Black Rubber	EACH	47.30	1	48	2.34



**TRASH CAN**

Lids and dollies are sold separately.

ITEM	DESCRIPTION	U/M	WEIGHT GROSS lbs	INNER PACK	MASTER PACK	CU. FT.
<b>Trash Can - Comparable to Slim Jim Trash Can</b>						
PLTC023G	23 gallon, Gray - 20" x 11¼" x 29¾"	EACH	7.46	1	1	0.74
PLTC023GL	Lid for PLTC023G, Gray - 20" 11¼" x 6¼"	EACH	16.64	1	10	3.03
PLTC023B	23 gallon, Brown - 20" x 11¼" x 29¾"	EACH	7.46	1	1	0.74
PLTC023BL	Lid for PLTC023B, Brown - 20" 11¼" x 6¼"	EACH	16.64	1	10	3.03
PLTC023K	23 gallon, Black - 20" x 11¼" x 29¾"	EACH	7.46	1	1	0.74
PLTC023KL	Lid for PLTC023K, Black - 20" 11¼" x 6¼"	EACH	16.64	1	10	3.03
PLTC023	Dolly for PLTC023 Series Trash Can - 24½" x 15¾" x 8¼" Inner Fitting Size: 17¼" x 8¼" x 3¼"	EACH	29.98	1	6	6.36
<b>Round Trash Can</b>						
PLTC010W	10 Gallon, Plastic, White - 15½" Diameter x 16½" Height	EACH	2.31	1	1	0.70
PLTC010WL	Lid For PLTC010W, White - 15½" Diameter x 1¼" Height	EACH	6.81	1	10	1.78
PLTC020G	20 Gallon, Plastic, Gray - 19½" Diameter x 22½" Height	EACH	5.06	1	1	1.34
PLTC020GL	Lid For PLTC020G, Gray - 19½" Diameter x 1¼" Height	EACH	10.64	1	10	2.06
PLTC020W	20 Gallon, Plastic, White - 19½" Diameter x 22½" Height	EACH	5.06	1	1	1.34
PLTC020WL	Lid For PLTC020W, White - 19½" Diameter x 1¼" Height	EACH	10.64	1	10	2.06
PLTC032G	32 gallon, Gray - 22½" Diameter x 27½" Height	EACH	22.80	1	1	4.10
PLTC032GL	Lid for PLTC032G, Gray - 19½" Diameter x 1¼" Height	EACH	22.80	1	10	3.56
PLTC032GH	Center Opened Lid For PLTC032G, Plastic, Gray - 22" Diameter x 1¼" Height. Center Opening 8¼" Diameter x ¾" Height	EACH	19.84	0	10	3.56
PLTC044G	44 gallon, Gray - 23½" Diameter x 31¼" Height	EACH	28.00	1	1	3.57
PLTC044GL	Lid for PLTC044G, Gray - 24½" Diameter x 1½" Height	EACH	28.00	1	10	4.06
PLTC044GH	Center Opened Lid For PLTC044G, Plastic, Gray - 24½" Diameter x 1½" Height. Center Opening 9¼" Diameter x ¾" Height	EACH	24.25	0	10	4.06
PLTC005	18" Diameter x 6" Black 5 Caster Trash Can Dolly - 1¼" Stem	EACH	36.93	1	6	4.24
<b>Recycling Trash Can</b>						
PLTC023R	Trash Can, 23 Gallon, Recycle Mark, Plastic - 20" x 11¼" x 29¾"	EACH	7.46	1	1	0.74
PLTC023RC	Bottles/Cans Recycle Lid, For PLTC023R - 20½" x 11¾" x 3"	EACH	17.64	0	20	2.58
PLTC023RL	Lid For PLTC023R - 20½" x 11¾" x 6¾"	EACH	16.64	1	10	3.03
PLTC023RP	Paper Recycle Lid For PLTC023R - 20½" x 11¾" x 3"	EACH	17.64	0	20	2.58

## BUS BOX

Heavy-duty and easy to clean with durable handles for quick kitchen transporting. Freezer-safe.



PLBT005B



PLBT005G



PLBT005W



PLBT002W



PLBT007B



PLBT007G



PLBT007W

ITEM	DESCRIPTION	U/M	WEIGHT GROSS lbs	INNER PACK	MASTER PACK	CU. FT.
PLBT002W	White 14½" x 12½" x 5½"	EACH	0.81	1	1	0.14
PLBT005B	Black, 20½" x 15½" x 5"	EACH	1.50	1	1	0.20
PLBT005G	Gray, 20½" x 15½" x 5"	EACH	1.50	1	1	0.20
PLBT005W	White, 20½" x 15½" x 5" Freezer Safe	EACH	1.50	1	1	0.20
PLBT007B	Black, 20½" x 15½" x 7"	EACH	1.95	1	1	0.30
PLBT007G	Gray, 20½" x 15½" x 7"	EACH	1.95	1	1	0.30
PLBT007W	White, 20½" x 15½" x 7" Freezer Safe	EACH	1.95	1	1	0.30

## BUS BOXES COVER

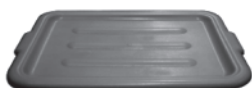

PLBTC001B



PLBTC001G



PLBTC001W



PLBTC002W

ITEM	DESCRIPTION	U/M	WEIGHT GROSS lbs	INNER PACK	MASTER PACK	CU. FT.
PLBTC001B	Black - Fits PLBT005B/ PLBT007B 21½" x 16" x 1"	EACH	63.03	1	48	4.99
PLBTC001G	Gray - Fits PLBT005G/ PLBT007G 21½" x 16" x 1"	EACH	63.03	1	48	4.99
PLBTC001W	White - Fits PLBT005W/ PLBT007W 21½" x 16" x 1" Freezer Safe	EACH	63.03	1	48	4.99
PLBTC002W	White -Fits PLBT002W 14½" x 12½" x 5½"	EACH	27.58	1	48	1.87

## PERFORATED BUS BOXES



PLBT505BPF



PLBT505GPF



PLBT505WPF

ITEM	DESCRIPTION	U/M	WEIGHT GROSS lbs	INNER PACK	MASTER PACK	CU. FT.
PLBT505BPF	Black, 20½" x 15½" x 5"	EACH	2.05	1	1	0.20
PLBT505GPF	Gray, 20½" x 15½" x 5"	EACH	2.05	1	1	0.20
PLBT505WPF	White, 20½" x 15½" x 5"	EACH	2.05	1	1	0.20





## BUS CARTS, BINS, & ACCESSORIES

Clean up tables, transport bins and other supplies efficiently. Carts come with 2 locking casters & 2 regular casters.



ITEM	DESCRIPTION	U/M	WEIGHT GROSS lbs	INNER PACK	MASTER PACK	CU. FT.
<b>3-Tier Bus Cart</b>						
PLBC3316B	3-Tier Bus Cart - Black 33½" x 16½" x 37"	EACH	24.25	1	1	2.79
PLBC3316G	3-Tier Bus Cart - Gray 33½" x 16½" x 37"	EACH	24.25	1	1	2.79
PLBC4019B	3-Tier Bus Cart - Black 40½" x 19¾" x 37½"	EACH	34.79	1	1	4.40
PLBC4019G	3-Tier Bus Cart - Gray 40½" x 19¾" x 37½"	EACH	34.79	1	1	4.40
<b>Accessories</b>						
PLBC0012B	Silverware Bin 13" x 9¼" x 7"	EACH	11.00	1	6	2.02
PLBC0013B	Refuse Bin 13" x 9¼" x 22"	EACH	27.06	1	6	4.20
PLCB4140	4" Wheel - 4" Diameter x 6½" Height w/ 2½" width on wheel For Bus Carts PLBC3316 / PLBC4019	EACH	25.24	4	24	0.89
PLCB4140B	4" Wheel with Brake - 4" Diameter x 6½" Height w/ 2½" width on wheel For Bus Carts PLBC3316 / PLBC4019	EACH	29.48	4	24	0.89

## FLOOR DRAIN STRAINER

Drain out water to keep floor dry and safe. Catch debris to prevent drain line blockage.



ITEM	DESCRIPTION	U/M	WEIGHT GROSS lbs	INNER PACK	MASTER PACK	CU. FT.
<b>Plastic</b>						
PLFDS285	ABS 8½" x 8½" x 2¼"	EACH	23.15	12	48	2.66
<b>Stainless Steel</b>						
SLFDS310	0.8 mm, 10" x 10" x 3"	EACH	33.07	6	24	0.64
SLFDS385	0.8 mm, 8½" x 8½" x 3"	EACH	41.89	12	24	3.20
SLFDS510	0.8 mm, 10" x 10" x 5"	EACH	48.50	6	24	2.32





PLFCCB001



PLFCCB001B



### CUTLERY BOX

ITEM	DESCRIPTION	U/M	WEIGHT GROSS lbs	INNER PACK	MASTER PACK	CU. FT.
PLFCCB001	4 Compartment, Gray 22½" x 13" x 4" Inside: 4⅞" x 10⅞" x 4"	EACH	2.03	1	1	0.37
PLFCCB001B	4 Compartment, Black 22½" x 13" x 4" Inside: 4⅞" x 10⅞" x 4"	EACH	2.03	1	1	0.37
SLSCB04	4 Compartment 16⅞" x 10" x 3⅞" Inside: 4⅞" x 9⅞" x 3⅞"	EACH	28.66	1	8	3.55



SLSCB04



### BUS BOX

Outer lips are used for easy-to-carry. Random colors; red and blue.

Durable!



PLDB003 ~ PLDB007



ITEM	DESCRIPTION	U/M	WEIGHT GROSS lbs	INNER PACK	MASTER PACK	CU. FT.
PLDB003	14⅞" x 11⅞" x 3⅞"	EACH	15.43	1	20	1.38
PLDB004	15¼" x 12¼" x 3¾"	EACH	19.84	1	20	1.65
PLDB005	17⅞" x 13⅞" x 4⅞"	EACH	28.66	1	20	2.65
PLDB006	19½" x 15½" x 5⅞"	EACH	38.58	1	20	3.48
PLDB007	21⅞" x 16⅞" x 6"	EACH	56.22	1	20	6.35

### DUNNAGE RACK

Constructed of heavy duty welded aluminum square tubes. Available in 3 sizes.

\* Shipped Freight Only - No UPS \*



ALUMINUM



ALDN2036~  
ALDN2036E



ALDN2048~  
ALDN2048E



ALDN2060 ~ ALDN2060E

ITEM	DESCRIPTION	U/M	WEIGHT GROSS lbs	INNER PACK	MASTER PACK	CU. FT.
<b>Height 12"</b>						
ALDN2036	20" x 36" x 12" Up to 1500 lb Load Capacity	EACH	45.25	1	6	9.78
ALDN2048	20" x 48" x 12" Up to 1800 lb Load Capacity	EACH	51.46	1	6	12.53
ALDN2060	20" x 60" x 12" Up to 2100 lb Load Capacity	EACH	65.72	1	6	15.46
<b>Height 8"</b>						
ALDN2036E	20" x 36" x 8" Up to 1200 lb Load Capacity	EACH	40.80	1	6	7.94
ALDN2048E	20" x 48" x 8" Up to 1500 lb Load Capacity	EACH	49.80	1	6	10.21
ALDN2060E	20" x 60" x 8" Up to 1800 lb Load Capacity	EACH	58.80	1	6	12.60



## SINK STRAINER

Rust resistant stainless steel sink strainer. Extra fine mesh lining for eliminating unwanted residue in drains. Light weight and easy to rinse.



ITEM	DESCRIPTION	U/M	WEIGHT GROSS lbs	INNER PACK	MASTER PACK	CU. FT.
<b>Narrow Rim</b>						
SLSN001	Sink Strainer - Large	EACH	50.26	12	720	3.96
SLSN002	Sink Strainer - Medium	EACH	30.86	12	720	2.13
SLSN003	Sink Strainer - Small	EACH	18.70	12	720	0.61
<b>Wide Rim</b>						
SLSN001W	Sink Strainer - Large (Wide Rim)	EACH	24.25	12	288	2.02
SLSN002W	Sink Strainer - Medium (Wide Rim)	EACH	15.43	12	288	0.93
SLSTR30	3" Sink Strainer with 2½" Stopper	EACH	26.46	12	144	1.93
SLSN335	3½" Sink Strainer	EACH	59.52	72	576	0.92

## RUBBER SCRAP BLOCK

Scrape off food residues and prevent water from draining into trash opening on the dish washing counter. Fits standard 5¾" receptacle openings.

ITEM	DESCRIPTION	U/M	WEIGHT GROSS lbs	INNER PACK	MASTER PACK	CU. FT.
PLRSB064	6½" Diameter x 4" Deep	EACH	46.30	1	12	1.44



## SCRUBBER PAD & BRISTLE

Scrubbers available in nylon scouring pad pot scrubber. Ideal for cleaning pots, pans, sink basins, and all scouring jobs. Helpful with dishwashing.



ITEM	DESCRIPTION	U/M	WEIGHT GROSS lbs	INNER PACK	MASTER PACK	CU. FT.
SLSC001	Scrubber Ball, 50g	DOZEN	18.08	1	12	1.58
SLSC002	Scrubber Pad, 42g	DOZEN	15.20	1	12	2.52
SLSC003	Scrubber Ball, 105g	DOZEN	34.61	1	12	3.38
PLNP001	Nylon Pad 100pcs/case 27g, 9½" x 6" x ¼"	CASE	7.22	1	1	1.25
PLNP002	Nylon Blend, 6 piece/pack	PACK	25.35	0	60	4.06
PLSB703	7" x 3½" x 4" Heavy Duty Handy Steel Bristle	EACH	28.82	1	72	2.93



# KITCHEN UTENSILS



## ONE-PIECE PLASTIC HANDLE ICE CREAM DISHER

One-piece plastic handle improves durability and prevents handle from coming apart. Bowl and components are made with 18/8 stainless steel to prevent corrosion. Color coded handles for accurate portions. Easy to clean.



SLDS206P SLDS208P SLDS210P SLDS212P SLDS216P SLDS220P SLDS224P SLDS230P SLDS240P

ITEM	DESCRIPTION	No.	U/M	WEIGHT GROSS lbs	INNER PACK	MASTER PACK	CU. FT.
SLDS206P	5½ oz White - 9¾" x 3¼" x 1½"	#6	EACH	15.39	1	36	1.33
SLDS208P	4 oz Gray - 9¾" x 3⅜" x 1½"	#8	EACH	14.75	1	36	1.33
SLDS210P	3¼ oz Ivory - 9¾" x 3⅜" x 1½"	#10	EACH	14.27	1	36	1.33
SLDS212P	2¾ oz Green - 9¼" x 3⅜" x 1½"	#12	EACH	13.64	1	36	1.33
SLDS216P	2 oz Blue - 9" x 3" x 1⅜"	#16	EACH	13.16	1	36	1.33
SLDS220P	1½ oz Yellow - 8⅞" x 3" x 1⅜"	#20	EACH	12.85	1	36	1.28
SLDS224P	1⅓ oz Red - 8⅞" x 3" x 1⅜"	#24	EACH	12.37	1	36	1.28
SLDS230P	1 oz Black - 8½" x 3" x 1⅝"	#30	EACH	12.21	1	36	1.28
SLDS240P	¾ oz Orchid - 8¼" x 3" x 1¼"	#40	EACH	11.90	1	36	1.28



## ONE-PIECE PLASTIC HANDLE ICE CREAM DISHER (EASY GRIP)

One-piece plastic handle improves durability and prevents handle from coming apart. Color coded handles for size and accurate portions. Acetal Copolymer plastic material makes the handle in low moisture absorption, dimensionally stable for tight tolerance. Easy to clean.



SLDS206G SLDS208G SLDS210G SLDS212G SLDS216G SLDS220G SLDS224G SLDS230G SLDS240G

ITEM	DESCRIPTION	No.	U/M	WEIGHT GROSS lbs	INNER PACK	MASTER PACK	CU. FT.
SLDS206G	5½ oz White - 9¾" x 3" x 1⅝"	#6	EACH	16.16	1	36	1.28
SLDS208G	4 oz Grey - 9¼" x 3" x 1½"	#8	EACH	15.52	1	36	1.28
SLDS210G	3¼ oz Ivory - 9" x 3" x 1½"	#10	EACH	15.05	1	36	1.28
SLDS212G	2¾ oz Green - 8⅞" x 3" x 1½"	#12	EACH	14.41	1	36	1.28
SLDS216G	2 oz Blue - 8⅞" x 3" x 1½"	#16	EACH	13.94	1	36	1.28
SLDS220G	1½ oz Yellow - 8½" x 2¾" x 1½"	#20	EACH	13.62	1	36	1.23
SLDS224G	1⅓ oz Red - 8¼" x 2¾" x 1½"	#24	EACH	13.14	1	36	1.23
SLDS230G	1 oz Black - 8½" x 2¾" x 1⅜"	#30	EACH	12.98	1	36	1.23
SLDS240G	¾ oz Orchid - 7⅞" x 2¼" x 1⅝"	#40	EACH	12.66	1	36	1.23



ICE CREAM DISHER



SLDS006 SLDS008 SLDS010 SLDS012 SLDS016 SLDS020 SLDS024 SLDS030 SLDS040

ITEM	DESCRIPTION	No.	U/M	WEIGHT GROSS lbs	INNER PACK	MASTER PACK	CU. FT.
A	SLDS006 5½ oz, White - 9" x 3½" x 1½"	#6	EACH	14.33	1	36	1.48
B	SLDS008 4 oz, Grey - 9" x 3" x 1½"	#8	EACH	13.67	1	36	1.48
C	SLDS010 3¼ oz, Ivory - 8¾" x 3" x 1½"	#10	EACH	13.23	1	36	1.48
D	SLDS012 2½ oz, Green - 8¾" x 3¼" x 1½"	#12	EACH	12.12	1	36	1.20
E	SLDS016 2 oz, Blue - 8¾" x 3½" x 1¾"	#16	EACH	11.02	1	36	1.10
F	SLDS020 1½ oz, Yellow - 8½" x 3¼" x 1¼"	#20	EACH	12.13	1	36	1.10
G	SLDS024 1½ oz, Red - 8¼" x 3" x 1¼"	#24	EACH	11.68	1	36	1.10
H	SLDS030 1 oz, Black - 8¼" x 2¾" x 1½"	#30	EACH	12.00	1	36	1.10
I	SLDS040 ¾ oz, Orchid - 7¾" x 2½" x 1½"	#40	EACH	11.00	1	36	1.10

Color Coded

18/8 SS STAINLESS STEEL



SLDS006L SLDS008L SLDS010L SLDS012L SLDS016L SLDS020L SLDS024L SLDS030L SLDS040L

ITEM	DESCRIPTION	No.	U/M	WEIGHT GROSS lbs	INNER PACK	MASTER PACK	CU. FT.
<b>Ergonomic Handle (Lever Dishers)</b>							
J	SLDS006L 5½ oz, White - 10½" x 3¼" x 1¾"	#6	EACH	14.77	1	36	1.55
K	SLDS008L 4 oz, Gray - 10¼" x 3¼" x 1¾"	#8	EACH	14.33	1	36	1.55
L	SLDS010L 3¼ oz, Ivory - 10¼" x 3¼" x 1¾"	#10	EACH	15.50	1	36	1.55
M	SLDS012L 2½ oz, Green - 10" x 3¼" x 1¼"	#12	EACH	13.67	1	36	1.26
N	SLDS016L 2 oz, Blue - 9¾" x 2¼" x 1½"	#16	EACH	13.23	1	36	1.30
O	SLDS020L 1½ oz, Yellow - 9½" x 3" x 1¼"	#20	EACH	13.00	1	36	1.30
P	SLDS024L 1½ oz, Red - 9½" x 3" x 1¾"	#24	EACH	12.79	1	36	1.30
Q	SLDS030L 1 oz, Black - 9¼" x 2¾" x 1½"	#30	EACH	12.57	1	36	1.30
R	SLDS040L ¾ oz, Orchid - 9¼" x 2¾" x 1½"	#40	EACH	12.35	1	36	1.29

Color Coded

18/8 SS STAINLESS STEEL



## ONE-PIECE PORTION CONTROLLER, 1 mm

Reliable stainless steel portion controller with plastic handle. Easy grip handle for precise measure of ingredients.



ITEM	DESCRIPTION	U/M	WEIGHT GROSS lbs	INNER PACK	MASTER PACK	CU. FT.
<b>Solid</b>						
A	SLLD002A 2 oz Red, 13" x 2 $\frac{5}{8}$ " x 1 $\frac{3}{4}$ "	EACH	27.60	12	120	2.05
B	SLLD003A 3 oz Ivory, 12 $\frac{5}{8}$ " x 2 $\frac{7}{8}$ " x 1 $\frac{3}{4}$ "	EACH	30.51	12	120	2.24
C	SLLD004A 4 oz Green, 13 $\frac{3}{4}$ " x 3 $\frac{1}{4}$ " x 1 $\frac{1}{2}$ "	EACH	34.65	12	120	2.71
D	SLLD006A 6 oz Black, 14 $\frac{3}{4}$ " x 4" x 1 $\frac{3}{4}$ "	EACH	38.72	12	120	3.55
E	SLLD008A 8 oz Blue, 14 $\frac{1}{2}$ " x 4 $\frac{1}{8}$ " x 2"	EACH	49.09	12	120	3.62
<b>Perforated</b>						
F	SLLD102PA 2 oz Red, 13" x 2 $\frac{5}{8}$ " x 1 $\frac{3}{4}$ ", Hole: $\frac{3}{16}$ "	EACH	27.60	12	120	2.05
G	SLLD103PA 3 oz Ivory, 12 $\frac{5}{8}$ " x 2 $\frac{7}{8}$ " x 1 $\frac{5}{8}$ ", Hole: $\frac{3}{16}$ "	EACH	30.51	12	120	2.24
H	SLLD104PA 4 oz Green, 13 $\frac{7}{8}$ " x 3 $\frac{1}{4}$ " x 1 $\frac{1}{2}$ ", Hole: $\frac{3}{16}$ "	EACH	34.65	12	120	2.71
I	SLLD106PA 6 oz Black, 14 $\frac{1}{4}$ " x 4" x 2", Hole: $\frac{3}{16}$ "	EACH	38.72	12	120	3.55
J	SLLD108PA 8 oz Blue, 15 $\frac{3}{8}$ " x 4 $\frac{5}{16}$ " x 1 $\frac{1}{4}$ ", Hole: $\frac{3}{16}$ "	EACH	49.09	12	120	3.62

## TWO-PIECE PORTION CONTROLLER, 1 mm

Reliable stainless steel portion controller with plastic handle. Easy grip handle for precise measure of ingredients.



ITEM	DESCRIPTION	U/M	WEIGHT GROSS lbs	INNER PACK	MASTER PACK	CU. FT.
<b>Solid</b>						
K	SLLD002 2 oz Blue, 13" x 2 $\frac{5}{8}$ " x 1 $\frac{3}{4}$ "	EACH	27.12	12	120	2.05
L	SLLD003 3 oz Ivory, 12 $\frac{5}{8}$ " x 2 $\frac{7}{8}$ " x 1 $\frac{3}{4}$ "	EACH	27.56	12	120	2.24
M	SLLD004 4 oz Gray, 13 $\frac{3}{4}$ " x 3 $\frac{1}{4}$ " x 1 $\frac{1}{2}$ "	EACH	25.35	12	120	2.71
N	SLLD006 6 oz Green, 14 $\frac{3}{4}$ " x 4" x 1 $\frac{3}{4}$ "	EACH	37.49	12	120	3.55
O	SLLD008 8 oz Orange, 14 $\frac{1}{2}$ " x 4 $\frac{1}{8}$ " x 2"	EACH	39.25	12	120	3.62
<b>Perforated</b>						
P	SLLD102P 2 oz Blue, 13" x 2 $\frac{5}{8}$ " x 1 $\frac{3}{4}$ ", Hole: $\frac{3}{16}$ "	EACH	27.12	12	120	2.05
Q	SLLD103P 3 oz Ivory, 12 $\frac{5}{8}$ " x 2 $\frac{7}{8}$ " x 1 $\frac{5}{8}$ ", Hole: $\frac{3}{16}$ "	EACH	27.56	12	120	2.24
R	SLLD104P 4 oz Gray, 13 $\frac{7}{8}$ " x 3 $\frac{1}{4}$ " x 1 $\frac{1}{2}$ ", Hole: $\frac{3}{16}$ "	EACH	25.35	12	120	2.71
S	SLLD106P 6 oz Green, 14 $\frac{1}{4}$ " x 4" x 2", Hole: $\frac{3}{16}$ "	EACH	37.49	12	120	3.55
T	SLLD108P 8 oz Orange, 15 $\frac{3}{8}$ " x 4 $\frac{5}{16}$ " x 1 $\frac{1}{4}$ ", Hole: $\frac{3}{16}$ "	EACH	39.25	12	120	3.62

**AMBIDEXTROUS SCOOP**

Ambidextrous twin grip handle. Tension free, spring release for easy handling.



ITEM	DESCRIPTION	No.	U/M	WEIGHT GROSS lbs	INNER PACK	MASTER PACK	CU. FT.
SLDA008	4 oz, 2 3/4" Bowl Diameter 9 3/4" x 2 7/8" x 1 1/2"	#8	EACH	45.76	1	120	3.42
SLDA010	3 3/4 oz, 2 5/8" Bowl Diameter 9 3/8" x 2 3/4" x 1 3/4"	#10	EACH	48.50	1	120	3.42
SLDA012	3 1/4 oz, 2 1/2" Bowl Diameter 9 3/8" x 2 3/4" x 1 1/2"	#12	EACH	48.50	1	120	3.42
SLDA016	2 3/4 oz, 2 1/4" Bowl Diameter 9" x 2 3/8" x 1 3/8"	#16	EACH	38.58	1	120	2.34
SLDA020	2 1/2 oz, 2 1/8" Bowl Diameter 8 7/8" x 2 3/8" x 1 3/8"	#20	EACH	41.89	1	120	2.28
SLDA024	1 3/4 oz, 2" Bowl Diameter 8 3/4" x 2 3/8" x 1 1/4"	#24	EACH	40.79	1	120	2.28
SLDA030	1 1/4 oz, 1 5/8" Bowl Diameter 8 3/4" x 2 3/8" x 1 1/4"	#30	EACH	38.58	1	120	2.28
SLDA040	7/8 oz, 1 3/4" Bowl Diameter 8 5/8" x 2 1/2" x 1 1/8"	#40	EACH	38.58	1	120	2.28
SLDA050	5/8 oz, 1 1/4" Bowl Diameter 8 1/2" x 2 3/8" x 1 3/8"	#50	EACH	37.48	1	120	2.14
SLDA060	3/4 oz, 1 1/2" Bowl Diameter 8 1/4" x 2 3/8" x 1 1/4"	#60	EACH	36.38	1	120	2.14
SLDA070	1/2 oz, 1 1/8" Bowl Diameter 8 1/4" x 2 3/8" x 1 1/4"	#70	EACH	36.38	1	120	2.14
SLDA100	3/8 oz, 1 1/4" Bowl Diameter 8" x 2 1/2" x 2 1/4"	#100	EACH	32.12	1	120	2.14
SLDAOVAL	1 1/2 oz, 1 3/8" x 2 1/2" Bowl Diameter 9 1/8" x 2 3/8" x 1 1/8"		EACH	39.60	1	120	2.51



**CAST ALUMINUM DIPPER**

These sturdy dipper are ideal for all-purpose portion servings.



ITEM	DESCRIPTION	U/M	WEIGHT GROSS lbs	INNER PACK	MASTER PACK	CU. FT.
<b>Aluminum</b>						
SLTHDP012	3 oz, Yellow - 7 1/8" x 2" x 1 5/8"	EACH	25.00	12	60	1.20
SLTHDP016	2 1/2 oz, Green - 7 1/8" x 1 3/4" x 1 1/2"	EACH	21.00	12	60	1.20
SLTHDP020	2 oz, Brown - 7 1/8" x 1 5/8" x 1 1/4"	EACH	20.00	12	60	1.20
SLTHDP024	1 1/2 oz, Red - 7 1/8" x 1 1/2" x 1 1/4"	EACH	19.00	12	60	1.20
<b>Non-Stick (Teflon)</b>						
SLTHDP112	3 oz, Yellow - 7 1/8" x 2" x 1 5/8"	EACH	25.00	12	60	1.20
SLTHDP116	2 1/2 oz, Green - 7 1/8" x 1 3/4" x 1 1/2"	EACH	21.00	12	60	1.20
SLTHDP120	2 oz, Brown - 7 1/8" x 1 5/8" x 1 1/4"	EACH	20.00	12	60	1.20
SLTHDP124	1 1/2 oz, Red - 7 1/8" x 1 1/2" x 1 1/4"	EACH	19.00	12	60	1.20



**ICE CREAM SPADE**

One-piece stainless steel spade with plastic white or black handle. Easily maintained with sponge or soft cloth.

ITEM	DESCRIPTION	U/M	WEIGHT GROSS lbs	INNER PACK	MASTER PACK	CU. FT.
SLTHCS001	White 10" x 3" x 7/8"	EACH	44.09	12	120	1.53
SLTHCS001B	Black 9" x 3" x 1 1/2"	EACH	44.09	12	120	1.27



Select cutter model by choosing a blade type with its pusher block.



### FRENCH FRY CUTTER SET

Heavy-duty cast iron body, handle & a stainless steel reciprocating rod. The frame, cutter & pusher block are all rust proof. It can be wall or table mounted. Durable and easy to clean.

ITEM	DESCRIPTION	U/M	WEIGHT GROSS lbs	INNER PACK	MASTER PACK	CU. FT.
IRFFC001	Square Cutter Set - w/ 1/4" Blade & Pusher 15 3/4" x 8" x 12 3/4"	EACH	11.30	1	1	0.81
IRFFC002	Square Cutter Set - w/ 3/8" Blade & Pusher 15 3/4" x 8" x 12 3/4"	EACH	11.30	1	1	0.81
IRFFC003	Square Cutter Set - w/ 1/2" Blade & Pusher 15 3/4" x 8" x 12 3/4"	EACH	11.30	1	1	0.81
IRFFC004	Wedge Cutter Set - w/ 6 Wedge Blade & Pusher 15 3/4" x 8" x 12 3/4"	EACH	11.30	1	1	0.81
IRFFC005	Wedge Cutter Set - w/ 8 Wedge Blade & Pusher 15 3/4" x 8" x 12 3/4"	EACH	11.30	1	1	0.81

### PARTS

1/4" Square  
IRFFC001



ITEM	DESCRIPTION	U/M	WEIGHT GROSS lbs	INNER PACK	MASTER PACK	CU. FT.
IRFFC001B	1/4" Square Blade - 4 5/8" x 4 5/8" x 3/4"	EACH	24.25	6	24	0.40
IRFFC001W	1/4" Square Pusher Block - 3" x 3" x 1"	EACH	7.64	6	24	0.23

3/8" Square  
IRFFC002



IRFFC002B	3/8" Square Blade - 4 5/8" x 4 5/8" x 3/4"	EACH	24.25	6	24	0.40
IRFFC002W	3/8" Square Pusher Block - 3" x 3" x 1"	EACH	7.64	6	24	0.23

1/2" Square  
IRFFC003



IRFFC003B	1/2" Square Blade - 4 5/8" x 4 5/8" x 3/4"	EACH	24.25	6	24	0.40
IRFFC003W	1/2" Square Pusher Block - 3" x 3" x 1"	EACH	7.64	6	24	0.23

6 Wedge  
IRFFC004



IRFFC004B	6 Wedge Blade - 4 5/8" x 4 5/8" x 3/4"	EACH	24.25	6	24	0.40
IRFFC004W	6 Wedge Pusher Block - 3" x 3" x 1"	EACH	7.64	6	24	0.23

8 Wedge  
IRFFC005



IRFFC005B	8 Wedge Blade - 4 5/8" x 4 5/8" x 3/4"	EACH	24.25	6	24	0.40
IRFFC005W	8 Wedge Pusher Block - 3" x 3" x 1"	EACH	7.64	6	24	0.23

IRFFC009H



IRFFC009H	Handle for French Fry Cutter - 19 1/4" x 3 1/4" x 2 3/4"	EACH	48.96	12	12	0.85
-----------	--	------	-------	----	----	------



IRFFC104

IRFFC104	French Fry Cutter Suction Cup Feet, PVC, Set of 4, 3 3/4" Diameter x 2 1/8"	SET	21.98	12	24	2.61
----------	---	-----	-------	----	----	------



\*French Fry Cutter Sold Separately



**FRENCH FRY BAGGER**

With removable dual handles. Shovel up and serve fries with fast efficiency. Reduces spills and serves even portions.



18/8 **SS** STAINLESS STEEL

ITEM	DESCRIPTION	U/M	WEIGHT GROSS lbs	INNER PACK	MASTER PACK	CU. FT.
SLFFB001	9" x 9" x 2 3/8" with Removable Dual Handle	EACH	74.96	12	72	6.09
SLFFB001L	9" x 9" x 2 3/8" with Left Handle	EACH	6.61	6	6	0.76
SLFFB001R	9" x 9" x 2 3/8" with Right Handle	EACH	6.61	6	6	0.76

**TACO SHELL BASKET**

Nickel plated basket with stainless steel framework and dividers.

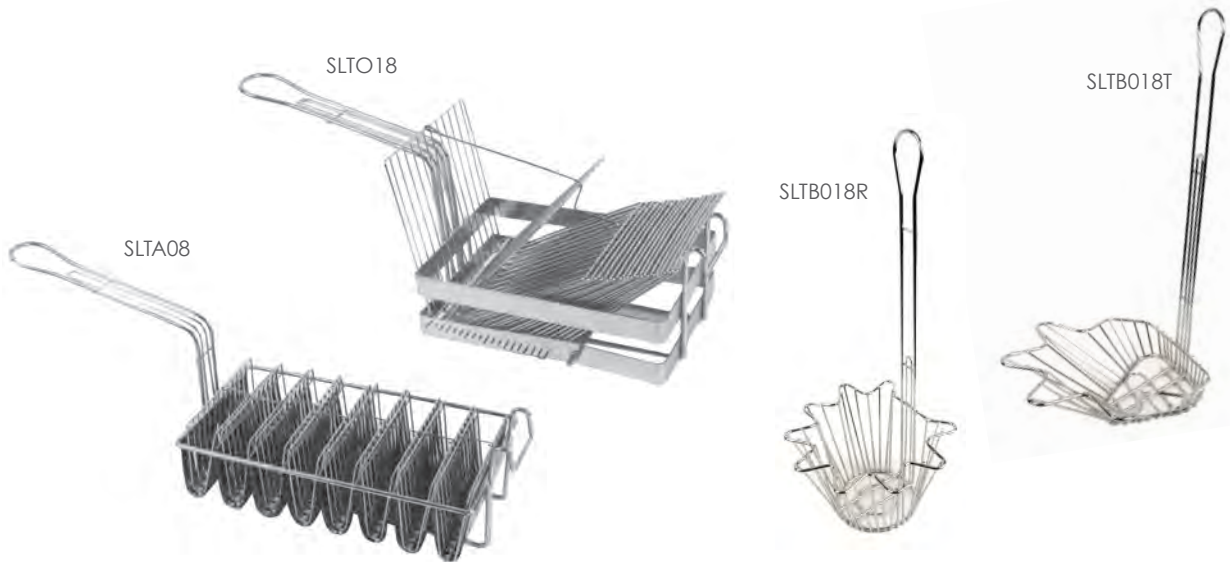

ITEM	DESCRIPTION	U/M	WEIGHT GROSS lbs	INNER PACK	MASTER PACK	CU. FT.
SLTA08	8 Taco Mold 21 1/4" x 6 3/4" x 9"	EACH	24.69	1	8	2.84
SLTO18	18 Slots, Heavy Duty Tostada Shell Baskets 19 3/8" x 6 1/4" x 7 5/8"	EACH	44.09	1	12	5.21
SLTB018R	Taco Salad Bowl Basket - 8 1/8" x 7 1/4" x 18 3/8", Round Base - Bowl Size 8" x 8" x 5"	EACH	17.01	1	12	0.89
SLTB018T	Taco Salad Bowl Basket - 9 1/4" x 8 7/8" x 16 3/4", Triangle Base - Bowl Size 8 3/4" x 9" x 4 1/2"	EACH	16.06	1	12	1.42

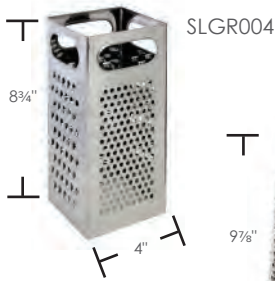

**GRATER**

Open ended and free standing stainless steel grater with four options at fine to coarse grating. Durable top handles added for stability while in use.



ITEM	DESCRIPTION	U/M	WEIGHT GROSS lbs	INNER PACK	MASTER PACK	CU. FT.
SLGR004	4" Square Grater 4" x 4" x 8 3/4"	EACH	20.24	1	24	2.99
SLGR025	Grater w/ Handle 4 1/4" x 2 7/8" x 9 7/8"	EACH	17.64	1	24	2.41

**PEELER**

Smooth double edge floating blade with a serrated blade for coring or scraping. Easy to wash.



ITEM	DESCRIPTION	U/M	WEIGHT GROSS lbs	INNER PACK	MASTER PACK	CU. FT.
SLKVP006	Peeler, 6" x 1" x 7/16"	DOZEN	7.72	1	12	0.25
SLKVP006RD	Peeler, 6" x 1" x 7/16" 3pc/ set	SET	22.05	8	96	1.60
OW358	Peeler, Black 7 1/2" x 1 1/4" x 1/2"	EACH	24.25	24	240	0.99



Enlarged to show detail.

**CHROME PLATED POTATO MASHER WITH WOOD HANDLE**

Potato masher with square or round face, with wooden handle. Easy to clean surface.



ITEM	DESCRIPTION	U/M	WEIGHT GROSS lbs	INNER PACK	MASTER PACK	CU. FT.
<b>Round</b>						
SLPMR018	18" 4 1/2" Diameter x 18"	EACH	23.15	12	24	2.27
SLPMR024	24" 5 1/8" Diameter x 24"	EACH	31.08	12	24	3.64
<b>Square</b>						
SLTMA012	12" 4 3/8" x 3 3/8" x 14 5/8"	EACH	39.02	12	96	3.15
SLTMA018	18" 5" x 4 1/8" x 18"	EACH	45.19	12	48	2.44
SLTMA024	24" 6 3/8" x 5 1/8" x 24"	EACH	71.94	12	48	3.71



**CHROME PLATED POTATO MASHER WITH SOFT GRIP HANDLE**

Chrome plated masher with square or round face, with soft grip. Easy to clean surface.

ITEM	DESCRIPTION	U/M	WEIGHT GROSS lbs	INNER PACK	MASTER PACK	CU. FT.
<b>Round</b>						
SLPMR018C	18" 4 5/8" Diameter x 18"	EACH	31.97	12	24	2.24
SLPMR024C	24" 5 3/16" Diameter x 24"	EACH	39.60	12	24	3.69
<b>Square</b>						
SLTMA018C	18" Square 5" x 4 7/8" x 18"	EACH	35.51	12	24	3.34
SLTMA024C	24" Square 6" x 6" x 24"	EACH	45.64	12	24	6.44

**POLYCARBONATE SCOOP**

Beveled tip for easy scooping of dry ingredients and ice. Features a hanging hole on the handle.



ITEM	DESCRIPTION	U/M	WEIGHT GROSS lbs	INNER PACK	MASTER PACK	CU. FT.
PLSC006CL	6 oz, 10¼" x 2¾" x 2¼"	EACH	23.81	12	144	2.70
PLSC012CL	12 oz, 11" x 3½" x 2⅝"	EACH	18.74	12	72	1.95
PLSC024CL	24 oz, 12½" x 4" x 2½"	EACH	17.64	12	48	1.94
PLSC064CL	64 oz, 14½" x 5⅝" x 4⅜"	EACH	16.53	12	24	1.80



**ALUMINUM SCOOP**

Rust-proof. Contoured handle for secure grip.



ITEM	DESCRIPTION	U/M	WEIGHT GROSS lbs	INNER PACK	MASTER PACK	CU. FT.
ALTWSC005	5 oz, 7⅞" x 2¼" x 1¼"	EACH	11.10	12	72	0.81
ALTWSC012	12 oz, 8" x 3¼" x 1⅝"	EACH	19.60	12	72	1.20
ALTWSC024	24 oz, 8½" x 3⅞" x 1⅞"	EACH	39.68	12	72	2.42
ALTWSC038	38 oz, 10⅜" x 3⅞" x 2¾"	EACH	30.90	12	48	2.20
ALTWSC058	58 oz, 12" x 4¾" x 3⅜"	EACH	41.20	12	36	3.70
ALTWSC085	85 oz, 11⅞" x 4⅞" x 3"	EACH	32.30	12	24	2.60



**ALUMINUM FLAT BOTTOM SCOOP**

Flat shape front with straight edge. Ideal for dry products.



ITEM	DESCRIPTION	U/M	WEIGHT GROSS	INNER PACK	MASTER PACK	CU. FT.
ALTWFC004	4 oz, 8¼" x 2⅞" x 1⅜"	EACH	21.70	12	120	0.80
ALTWFC007	7 oz, 10" x 3⅝" x 2⅜"	EACH	32.40	12	120	1.20
ALTWFC016	16 oz, 10½" x 4" x 2½"	EACH	37.50	12	120	1.50



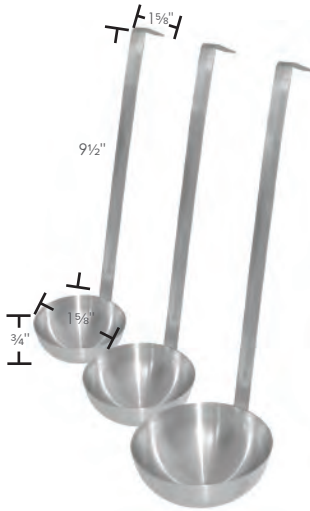

SLTL001 ~ SLTL012



SLOL001 ~ SLOL008



SLGL001

SLSL003



SLSL001

SLSL002

## TWO-PIECE LADLE

Available in different sizes. Two piece stainless steel ladle, can be conveniently nested on pot rim or hung on rack. Used for small condiments or large soup pots.



ITEM	DESCRIPTION	U/M	WEIGHT GROSS lbs	INNER PACK	MASTER PACK	CU. FT.
SLTL001	1/2 oz, 1 5/8" Diameter x 3/4" with 9 1/2" x 1/2" Handle, Bend 1 5/8" x 1/2"	EACH	15.43	12	120	1.13
SLTL002	1 oz, 1 7/8" Diameter x 1" with 10" x 1/2" Handle, Bend 1 5/8" x 1/2"	EACH	20.90	12	120	2.08
SLTL003	2 oz, 2 1/2" Diameter x 1 1/4" with 10 1/2" x 1/2" Handle, Bend 1 5/8" x 1/2"	EACH	23.10	12	120	1.41
SLTL004	3 oz, 2 1/2" Diameter x 1 1/4" with 12" x 1/2" Handle, Bend 1 5/8" x 1/2"	EACH	35.27	12	120	2.39
SLTL005	4 oz, 3" Diameter x 1 3/8" with 12" x 1/2" Handle, Bend 1 5/8" x 1/2"	EACH	36.30	12	120	2.83
SLTL006	6 oz, 3 5/8" Diameter x 1 3/4" with 12 5/8" x 5/8" Handle, Bend 1 3/4" x 5/8"	EACH	44.09	12	120	2.96
SLTL007	8 oz, 3 7/8" Diameter x 1 7/8" with 12 5/8" x 5/8" Handle, Bend 1 3/4" x 5/8"	EACH	47.40	12	120	3.86
SLTL008	10 oz, 4 1/4" Diameter x 1 7/8" with 12 5/8" x 5/8" Handle, Bend 1 3/4" x 5/8"	EACH	58.00	12	120	4.11
SLTL009	12 oz, 4 3/4" Diameter x 1 7/8" with 15 1/2" x 3/4" Handle, Bend 1 3/4" x 3/4"	EACH	33.00	6	60	2.58
SLTL010	16 oz, 5" Diameter x 2 1/8" with 15 1/2" x 3/4" Handle, Bend 1 3/4" x 3/4"	EACH	40.00	6	60	4.93
SLTL011	24 oz, 5 5/8" Diameter x 2 1/8" with 16 1/4" x 1" Handle, Bend 1 3/4" x 1"	EACH	47.30	6	60	4.07
SLTL012	32 oz, 6 1/4" Diameter x 3" with 16 1/4" x 1" Handle, Bend 1 3/4" x 1"	EACH	47.40	6	60	4.43

## ONE-PIECE LADLE

Can be conveniently stored on pot rim or hung on rack. Used for small condiments or large soup pots.



ITEM	DESCRIPTION	U/M	WEIGHT GROSS lbs	INNER PACK	MASTER PACK	CU. FT.
SLOL001	1/2 oz, 1 3/4" Diameter x 1/2" with 10" x 1/2" Handle, Bend 2 3/8" x 1/2"	EACH	32.46	12	240	1.97
SLOL002	1 oz, 2 1/4" Diameter x 1 7/8" with 10" x 1/2" Handle, Bend 2 3/8" x 1/2"	EACH	37.75	12	240	2.41
SLOL003	2 oz, 2 5/8" Diameter x 1" with 10" x 3/4" Handle, Bend 2 3/8" x 5/8"	EACH	48.86	12	240	2.38
SLOL004	3 oz, 2 5/8" Diameter x 1 1/8" with 11 1/8" x 3/4" Handle, Bend 2 3/4" x 3/4"	EACH	61.56	12	240	5.31
SLOL005	4 oz, 3 1/4" Diameter x 1 1/2" with 11 1/8" x 3/4" Handle, Bend 2 3/4" x 3/4"	EACH	66.32	12	240	6.14
SLOL006	6 oz, 3 3/4" Diameter x 1 5/8" with 11 1/8" x 3/4" Handle, Bend 2 3/4" x 3/4"	EACH	41.71	12	120	2.97
SLOL007	8 oz, 4" Diameter x 1 3/4" with 11 1/4" x 3/4" Handle, Bend 3" x 3/4"	EACH	45.68	12	120	3.32
SLOL007H	10 oz, 4 1/4" Diameter x 1 7/8" with 11 1/4" x 3/4" Handle, Bend 3 1/4" x 3/4"	EACH	50.70	12	120	3.70
SLOL008	12 oz, 4 3/4" Diameter x 1 3/4" with 11 1/4" x 3/4" Handle, Bend 3" x 3/4"	EACH	58.38	12	120	4.99

## GRAVY LADLE

For stylish and safe food service. Easy to clean, for many occasions to come.



ITEM	DESCRIPTION	U/M	WEIGHT GROSS lbs	INNER PACK	MASTER PACK	CU. FT.
SLGL001	1 oz Ladle, 2 1/4" Diameter x 5/8" with 5 3/4" x 5/8" Handle	EACH	35.50	12	240	0.80
SLSL003	2 oz Ladle Sunflower, 3" Diameter x 1" with 3 7/8" x 1 1/8" Handle	EACH	40.79	12	120	1.38
SLSL001	4 1/2 oz Ladle Sunflower, 3 3/4" Diameter x 1 3/8" with 9 1/4" x 1 3/8" Handle	EACH	62.17	12	144	1.90
SLSL002	4 oz Ladle Sunflower, 3 1/2" Diameter x 1 1/8" with 9 1/4" x 1 3/8" Handle	EACH	55.78	12	144	1.70

### HIGH HEAT NYLON KITCHEN UTENSIL

- \* Black Color
- \* Heat Resistant up to 410° F



ITEM	DESCRIPTION	U/M	WEIGHT GROSS lbs	INNER PACK	MASTER PACK	CU. FT.
PLPP001BK	12" x 3" x 1½" Turner	EACH	17.18	12	144	1.90
PLPP002BK	12" x 3" x 1½" Spatula	EACH	22.47	12	144	2.32
PLPP003BK	11⅞" x 3" x 1½" Fork	EACH	17.18	12	144	1.90
PLPP004BK	11½" x 3" x 1½" Spoon	EACH	16.52	12	144	1.90
PLPP005BK	11½" x 3" x 1½" Spoon	EACH	16.52	12	144	1.90
PLPP006BK	12½" x 3" x 1½" Skimmer	EACH	20.70	12	144	3.01
PLPP007BK	11⅞" x 3" x 1½" Ladle	EACH	19.52	12	144	2.89
PLPP008BK	12¾" x 3" x 1½" 2-Prong Fork	EACH	17.62	12	144	1.70
PLPP009BK	9½" x 3" x 1½" Masher	EACH	23.35	12	144	3.45
PLPP010BK	12" x 3" x 1½" Turner	EACH	20.93	12	144	3.02
PLPP011BK	12" x 3" x 1½" Turner	EACH	22.16	12	144	3.02
PLPP012BK	12½" x 3" x 1½" Whip	EACH	18.72	12	144	2.89



### MULTI-PURPOSE SERVING SPOON



ITEM	DESCRIPTION	U/M	WEIGHT GROSS lbs	INNER PACK	MASTER PACK	CU. FT.
SLTTS001	10", Spoon Size: 3⅞" x 4⅞", Handle: 5⅞"	EACH	48.51	12	144	1.51
SLTTS001	8⅞", Spoon Size: 2½" x 3¼", Handle: 5⅞"	EACH	28.67	12	144	1.60



### VEGETABLE SPOON

Concave angled stainless steel spoon, with light plastic handle. Easy to clean.

ITEM	DESCRIPTION	U/M	WEIGHT GROSS lbs	INNER PACK	MASTER PACK	CU. FT.
SLLA001	9⅞" x 2¾" x 1⅞" with Plastic Handle	EACH	47.18	10	480	3.42
SLLA002	9⅞" x 2¾" x 1⅞" with Wood Handle	EACH	48.50	10	500	3.81





SLTHUH001

**BUFFET UTENSIL HOLDER**

- Keep the serving areas free of mess
- No more over-heated ladels / spactulars
- Avoid food conamination
- Adjustable height
- Fits most buffet tables

ITEM	DESCRIPTION	U/M	WEIGHT GROSS lbs	INNER PACK	MASTER PACK	CU. FT.
SLTHUH001	Utensil Holder, Hook Style 5" x 5" x 99/4"	EACH	30.52	6	24	1.73

**Patent Pending:  
US201502166364 A1**

SLSBA411



SLSBA412



SLSBA413



SLSBA511



SLSBA512



SLSBA513



SLSBA611



SLSBA612



SLSBA613



**BASTING SPOON**

Ergonomic curved handle. Shiny polished finish.



ITEM	DESCRIPTION	U/M	WEIGHT GROSS lbs	INNER PACK	MASTER PACK	CU. FT.
<b>11 inch</b>						
SLSBA411	11" Solid Basting Spoon, Curved Handle	EACH	29.28	12	120	0.83
SLSBA412	11" Slotted Spoon, Curved Handle	EACH	27.60	12	120	0.83
SLSBA413	11" Perforated Basting Spoon, Curved Handle	EACH	27.73	12	120	0.83
<b>13 inch</b>						
SLSBA511	13" Solid Basting Spoon, Curved Handle	EACH	31.86	12	120	1.03
SLSBA512	13" Slotted Spoon, Curved Handle	EACH	30.53	12	120	1.03
SLSBA513	13" Perforated Basting Spoon, Curved Handle	EACH	30.64	12	120	1.03
<b>15 inch</b>						
SLSBA611	15" Solid Basting Spoon, Curved Handle	EACH	35.76	12	120	1.08
SLSBA612	15" Slotted Spoon, Curved Handle	EACH	34.28	12	120	1.08
SLSBA613	15" Perforated Basting Spoon, Curved Handle	EACH	34.44	12	120	1.08

**Basting Covers**

With heat-resistant Bakelite knob. Keeps meals warm and moist before serving.



ALBD007



ALBD006

ITEM	DESCRIPTION	U/M	WEIGHT GROSS lbs	INNER PACK	MASTER PACK	CU. FT.
ALBC007	7" Diameter x 2" height with 1 1/2" diameter x 1" height	EACH	17.60	6	48	1.25
ALBC008	8" Diameter x 2" height with 1 1/2" Diameter x 7/8" height	EACH	6.20	6	12	0.32
ALBC009	9" Diameter x 2" height with 1 1/2" Diameter x 1 1/8" height	EACH	6.60	6	12	0.44
ALBC010	10" Diameter x 2 1/8" height with 1 1/2" Diameter x 3/4" height	EACH	7.70	6	12	0.53
ALBD006	6" Diameter x 2 1/4" Height with 1" Diameter x 3/4" Height	EACH	8.80	6	12	0.59

**BASTING SPOON**

Heavy duty stainless steel spoons with easy grip plastic handle. Safety notch to prevent slippage into pan. Available in solid, slotted, or perforated spoons.

ITEM	DESCRIPTION	U/M	WEIGHT GROSS lbs	INNER PACK	MASTER PACK	CU. FT.
<b>Plastic Handle, 1.2 mm</b>						
SLPBA111	11" Solid - 4 1/8" x 2 5/8", 6 3/4" Handle (included 4 7/8" Black Plastic Grip)	EACH	27.61	12	120	1.54
SLPBA112	11" Slotted - 4 1/8" x 2 5/8", 6 3/4" Handle (included 4 7/8" Black Plastic Grip)	EACH	26.03	12	120	1.54
SLPBA113	11" Perforated - 4 1/8" x 2 5/8", 6 3/4" Handle (included 4 7/8" Black Plastic Grip)	EACH	26.56	12	120	1.54
SLPBA211	13" Solid - 4 1/8" x 2 5/8", 8 3/4" Handle (included 4 7/8" Black Plastic Grip)	EACH	29.47	12	120	2.05
SLPBA212	13" Slotted - 4 1/8" x 2 5/8", 8 3/4" Handle (included 4 7/8" Black Plastic Grip)	EACH	27.09	12	120	2.05
SLPBA213	13" Perforated - 4 1/8" x 2 5/8", 8 3/4" Handle (included 4 7/8" Black Plastic Grip)	EACH	27.61	12	120	2.05
SLPBA311	15" Solid - 4 1/8" x 2 5/8", 10 3/4" Handle (included 4 7/8" Black Plastic Grip)	EACH	32.65	12	120	2.18
SLPBA312	15" Slotted - 4 1/8" x 2 5/8", 10 3/4" Handle (included 4 7/8" Black Plastic Grip)	EACH	29.74	12	120	2.18
SLPBA313	15" Perforated - 4 1/8" x 2 5/8", 10 3/4" Handle (included 4 7/8" Black Plastic Grip)	EACH	30.80	12	120	2.18
<b>Stainless Steel Handle, 1.2 mm</b>						
SLSBA111	11" Solid - 4 1/8" x 2 5/8", 7 1/4" Handle, Hanging Slot: 1 1/2" x 1/2"	EACH	26.03	12	120	0.61
SLSBA112	11" Slotted - 4 1/8" x 2 5/8", 7 1/4" Handle, Hanging Slot: 1 1/2" x 1/2"	EACH	24.97	12	120	0.61
SLSBA113	11" Perforated - 4 1/8" x 2 5/8", 7 1/4" Handle, Hanging Slot: 1 1/2" x 1/2"	EACH	24.97	12	120	0.61
SLSBA211	13" Solid - 4 1/8" x 2 5/8", 8 7/8" Handle, Hanging Slot: 1 1/2" x 1/2"	EACH	30.35	12	120	0.74
SLSBA212	13" Slotted - 4 1/8" x 2 5/8", 8 7/8" Handle, Hanging Slot: 1 1/2" x 1/2"	EACH	29.29	12	120	0.74
SLSBA213	13" Perforated - 4 1/8" x 2 5/8", 8 7/8" Handle, Hanging Slot: 1 1/2" x 1/2"	EACH	29.29	12	120	0.74
SLSBA311	15" Solid - 4 1/8" x 2 5/8", 10 3/4" Handle, Hanging Slot: 1 1/2" x 1/2"	EACH	37.08	12	120	0.80
SLSBA312	15" Slotted - 4 1/8" x 2 5/8", 10 3/4" Handle, Hanging Slot: 1 1/2" x 1/2"	EACH	33.64	12	120	0.80
SLSBA313	15" Perforated - 4 1/8" x 2 5/8", 10 3/4" Handle, Hanging Slot: 1 1/2" x 1/2"	EACH	33.64	12	120	0.80
<b>Extra Long, 1.5 mm</b>						
SLSBA018	18" Solid - 4 1/2" x 2 3/4", 13 7/8" Handle, Hanging Slot: 3/8" Diameter	EACH	53.62	12	120	1.65
SLSBA021	21" Solid - 4 1/2" x 2 3/4", 16 3/4" Handle, Hanging Slot: 3/8" Diameter	EACH	57.85	12	120	2.44

SLPBA111



SLPBA112



SLPBA113



Perforated Hole: 1/4" & 1/8"



SLSBA111



SLSBA112



SLSBA113



Slot Sizes: 1" x 1/4", 7/8" x 1/4", 2/3" x 1/4"

Hanging Slot: 1 1/2" x 1/2"

Perforated Hole: 1/4" & 1/8" Diameter

SLSBA018



**STAINLESS STEEL ONE PIECE COLOR-CODED LADLE**

Vinyl color coated to prevent cracking, peeling or slipping off.



ITEM	DESCRIPTION	U/M	WEIGHT GROSS lbs	INNER PACK	MASTER PACK	CU. FT.
SLOL201	½ oz, Teal, 1¾" Diameter x ½" HTS, 10¼" Length x ½" Width Handle (included 4½" Length x ⅝" Width Plastic Grip)	EACH	19.07	12	120	1.27
SLOL202	1 oz, Yellow, 2½" Diameter x ⅞" HTS, 10¼" Length x ½" Width Handle (included 4½" Length x ⅝" Width Plastic Grip)	EACH	23.85	12	120	1.46
SLOL203	2 oz, Red, 2½" Diameter x 1" HTS, 10¼" Length x ¾" Width Handle (included 4¾" Length x ¾" Width Plastic Grip)	EACH	30.48	12	120	1.71
SLOL204	3 oz, Ivory, 2½" Diameter x 1½" HTS, 10¾" Length x ¾" Width Handle (included 5¾" Length x ¾" Width Plastic Grip)	EACH	33.82	12	120	2.19
SLOL205	4 oz, Green, 3¼" Diameter x 1½" HTS, 11¾" Length x ¾" Width Handle (included 5¼" Length x ¾" Width Plastic Grip)	EACH	40.24	12	120	2.71
SLOL206	6 oz, Black, 3¾" Diameter x 1½" HTS, 12" Length x ¾" Width Handle (included 5½" Length x ¾" Width Plastic Grip)	EACH	49.00	12	120	2.77
SLOL207	8 oz, Blue, 4" Diameter x 1¾" HTS, 12¼" Length x ¾" Width Handle (included 5¾" Length x ¾" Width Plastic Grip)	EACH	27.81	12	60	1.73
SLOL208	12 oz, Gray, 4¾" Diameter x 2" HTS, 12¾" Length x ¾" Width Handle (included 5¾" Length x ¾" Width Plastic Grip)	EACH	32.97	12	60	1.87

**SS** STAINLESS STEEL Color Coded  
Thickness: 0.95mm

**POLYCARBONATE ONE PIECE LADLE**

One piece ladle can be used to serve hot or cold foods.



ITEM	DESCRIPTION	U/M	WEIGHT GROSS lbs	INNER PACK	MASTER PACK	CU. FT.
PLOP009BG	¾ oz Beige, 8½" x 2¼" x 1⅞"	EACH	11.42	12	120	1.37
PLOP009BK	¾ oz Black, 8½" x 2¼" x 1⅞"	EACH	11.42	12	120	1.37
PLOP009CL	¾ oz Clear, 8½" x 2¼" x 1⅞"	EACH	11.42	12	120	1.37
PLOP009GR	¾ oz Green, 8½" x 2¼" x 1⅞"	EACH	11.42	12	120	1.37
PLOP009RD	¾ oz Red, 8½" x 2¼" x 1⅞"	EACH	11.42	12	120	1.37
PLOP009WH	¾ oz White, 8½" x 2¼" x 1⅞"	EACH	11.42	12	120	1.37
PLOP010BG	1 oz Beige, 10½" x 2⅜" x 1⅞"	EACH	14.07	12	120	1.94
PLOP010BK	1 oz Black, 10½" x 2⅜" x 1⅞"	EACH	14.07	12	120	1.94
PLOP010CL	1 oz Clear, 10½" x 2⅜" x 1⅞"	EACH	14.07	12	120	1.94
PLOP010GR	1 oz Green, 10½" x 2⅜" x 1⅞"	EACH	14.07	12	120	1.94
PLOP010RD	1 oz Red, 10½" x 2⅜" x 1⅞"	EACH	14.07	12	120	1.94
PLOP010WH	1 oz White, 10½" x 2⅜" x 1⅞"	EACH	14.07	12	120	1.94
PLOP013BG	1 oz Beige, 13" x 2⅜" x 2"	EACH	15.67	12	120	1.67
PLOP013BK	1 oz Black, 13" x 2⅜" x 2"	EACH	15.67	12	120	1.67
PLOP013CL	1 oz Clear, 13" x 2⅜" x 2"	EACH	15.67	12	120	1.67
PLOP013GR	1 oz Green, 13" x 2⅜" x 2"	EACH	15.67	12	120	1.67
PLOP013RD	1 oz Red, 13" x 2⅜" x 2"	EACH	15.67	12	120	1.67
PLOP013WH	1 oz White, 13" x 2⅜" x 2"	EACH	15.67	12	120	1.67

**BREAK RESISTANT** **DISHWASHER SAFE** **SHATTER RESISTANT** **NSF**  
**PC** POLYCARBONATE



**POLYCARBONATE SOLID SERVING SPOON**

Serving spoons made of polycarbonate.



PLSS211BG      PLSS211BK      PLSS211CL      PLSS211GR      PLSS211RD      PLSS211WH



ITEM	DESCRIPTION	U/M	WEIGHT GROSS lbs	INNER PACK	MASTER PACK	CU. FT.
PLSS211BG	13" x 2 7/8" x 1 1/16" Beige	DOZEN	10.27	1	6	0.95
PLSS211BK	13" x 2 7/8" x 1 1/16" Black	DOZEN	10.27	1	6	0.95
PLSS211CL	13" x 2 7/8" x 1 1/16" Clear	DOZEN	10.27	1	6	0.95
PLSS211GR	13" x 2 7/8" x 1 1/16" Green	DOZEN	10.27	1	6	0.95
PLSS211RD	13" x 2 7/8" x 1 1/16" Red	DOZEN	10.27	1	6	0.95
PLSS211WH	13" x 2 7/8" x 1 1/16" White	DOZEN	10.27	1	6	0.95

**POLYCARBONATE PERFORATED SERVING SPOON**

Serving spoon made of polycarbonate.



PLSS213BG      PLSS213BK      PLSS213CL      PLSS213GR      PLSS213RD      PLSS213WH



ITEM	DESCRIPTION	U/M	WEIGHT GROSS lbs	INNER PACK	MASTER PACK	CU. FT.
PLSS213BG	13" x 2 7/8" x 1 1/16" Beige	DOZEN	10.12	1	6	0.95
PLSS213BK	13" x 2 7/8" x 1 1/16" Black	DOZEN	10.12	1	6	0.95
PLSS213CL	13" x 2 7/8" x 1 1/16" Clear	DOZEN	10.12	1	6	0.95
PLSS213GR	13" x 2 7/8" x 1 1/16" Green	DOZEN	10.12	1	6	0.95
PLSS213RD	13" x 2 7/8" x 1 1/16" Red	DOZEN	10.12	1	6	0.95
PLSS213WH	13" x 2 7/8" x 1 1/16" White	DOZEN	10.12	1	6	0.95

**POLYCARBONATE SOLID SERVING SPOON**

Serving spoon made of polycarbonate.



PLSS111BG      PLSS111BK      PLSS111CL      PLSS111GR      PLSS111RD      PLSS111WH

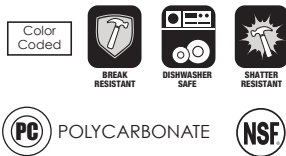

ITEM	DESCRIPTION	U/M	WEIGHT GROSS lbs	INNER PACK	MASTER PACK	CU. FT.
PLSS111BG	11" x 2 7/8" x 1 3/4" Beige	DOZEN	9.33	1	6	0.83
PLSS111BK	11" x 2 7/8" x 1 3/4" Black	DOZEN	9.33	1	6	0.83
PLSS111CL	11" x 2 7/8" x 1 3/4" Clear	DOZEN	9.33	1	6	0.83
PLSS111GR	11" x 2 7/8" x 1 3/4" Green	DOZEN	9.33	1	6	0.83
PLSS111RD	11" x 2 7/8" x 1 3/4" Red	DOZEN	9.33	1	6	0.83
PLSS111WH	11" x 2 7/8" x 1 3/4" White	DOZEN	9.33	1	6	0.83

**POLYCARBONATE PERFORATED SERVING SPOON**

Serving spoon made of polycarbonate.



PLSS113BG      PLSS113BK      PLSS113CL      PLSS113GR      PLSS113RD      PLSS113WH

ITEM	DESCRIPTION	U/M	WEIGHT GROSS lbs	INNER PACK	MASTER PACK	CU. FT.
PLSS113BG	11" x 2 7/8" x 1 3/4" Beige	DOZEN	9.33	1	6	0.83
PLSS113BK	11" x 2 7/8" x 1 3/4" Black	DOZEN	9.33	1	6	0.83
PLSS113CL	11" x 2 7/8" x 1 3/4" Clear	DOZEN	9.33	1	6	0.83
PLSS113GR	11" x 2 7/8" x 1 3/4" Green	DOZEN	9.33	1	6	0.83
PLSS113RD	11" x 2 7/8" x 1 3/4" Red	DOZEN	9.33	1	6	0.83
PLSS113WH	11" x 2 7/8" x 1 3/4" White	DOZEN	9.33	1	6	0.83



**POLYCARBONATE SOLID BUFFET SPOON**

Serving spoon made of polycarbonate.



PLBS010GR      PLBS010BK      PLBS010CL      PLBS010BG      PLBS010RD      PLBS010WH

ITEM	DESCRIPTION	U/M	WEIGHT GROSS lbs	INNER PACK	MASTER PACK	CU. FT.
PLBS010BG	10" x 1 1/16" x 1", 3/4 oz, Beige	DOZEN	10.14	1	12	0.70
PLBS010BK	10" x 1 1/16" x 1", 3/4 oz, Black	DOZEN	10.14	1	12	0.70
PLBS010CL	10" x 1 1/16" x 1", 3/4 oz, Clear	DOZEN	10.14	1	12	0.70
PLBS010GR	10" x 1 1/16" x 1", 3/4 oz, Green	DOZEN	10.14	1	12	0.70
PLBS010RD	10" x 1 1/16" x 1", 3/4 oz, Red	DOZEN	10.14	1	12	0.70
PLBS010WH	10" x 1 1/16" x 1", 3/4 oz, White	DOZEN	10.14	1	12	0.70



**POLYCARBONATE PERFORATED BUFFET SPOON**

Serving spoon made of polycarbonate.



PLBS110BG      PLBS110BK      PLBS110CL      PLBS110GR      PLBS110RD      PLBS110WH

ITEM	DESCRIPTION	U/M	WEIGHT GROSS lbs	INNER PACK	MASTER PACK	CU. FT.
PLBS110BG	10" x 1 1/16" x 1", 3/4 oz, Beige	DOZEN	10.14	1	12	0.70
PLBS110BK	10" x 1 1/16" x 1", 3/4 oz, Black	DOZEN	10.14	1	12	0.70
PLBS110CL	10" x 1 1/16" x 1", 3/4 oz, Clear	DOZEN	10.14	1	12	0.70
PLBS110GR	10" x 1 1/16" x 1", 3/4 oz, Green	DOZEN	10.14	1	12	0.70
PLBS110RD	10" x 1 1/16" x 1", 3/4 oz, Red	DOZEN	10.14	1	12	0.70
PLBS110WH	10" x 1 1/16" x 1", 3/4 oz, White	DOZEN	10.14	1	12	0.70

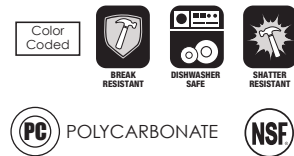

**POLYCARBONATE SCALLOP GRIP TONG**

Can be used to serve hot or cold foods.



PLSGTG006BG



PLSGTG006BK



PLSGTG006CL



PLSGTG006GR



PLSGTG006RD



PLSGTG006WH

Color Coded



POLYCARBONATE



ITEM	DESCRIPTION	U/M	WEIGHT GROSS lbs	INNER PACK	MASTER PACK	CU. FT.
PLSGTG006BG	6" x 2¼" x 1¼", Beige	EACH	8.07	12	120	1.05
PLSGTG006BK	6" x 2¼" x 1¼", Black	EACH	8.07	12	120	1.05
PLSGTG006CL	6" x 2¼" x 1¼", Clear	EACH	8.07	12	120	1.05
PLSGTG006GR	6" x 2¼" x 1¼", Green	EACH	8.07	12	120	1.05
PLSGTG006RD	6" x 2¼" x 1¼", Red	EACH	8.07	12	120	1.05
PLSGTG006WH	6" x 2¼" x 1¼", White	EACH	8.07	12	120	1.05
PLSGTG009BG	9" x 3" x 1⅝", Beige	EACH	16.12	12	120	1.66
PLSGTG009BK	9" x 3" x 1⅝", Black	EACH	16.12	12	120	1.66
PLSGTG009CL	9" x 3" x 1⅝", Clear	EACH	16.12	12	120	1.66
PLSGTG009GR	9" x 3" x 1⅝", Green	EACH	16.12	12	120	1.66
PLSGTG009RD	9" x 3" x 1⅝", Red	EACH	16.12	12	120	1.66
PLSGTG009WH	9" x 3" x 1⅝", White	EACH	16.12	12	120	1.66
PLSGTG012BG	12" x 3⅝" x 1¾", Beige	EACH	24.93	12	120	3.02
PLSGTG012BK	12" x 3⅝" x 1¾", Black	EACH	24.93	12	120	3.02
PLSGTG012CL	12" x 3⅝" x 1¾", Clear	EACH	24.93	12	120	3.02
PLSGTG012GR	12" x 3⅝" x 1¾", Green	EACH	24.93	12	120	3.02
PLSGTG012RD	12" x 3⅝" x 1¾", Red	EACH	24.93	12	120	3.02
PLSGTG012WH	12" x 3⅝" x 1¾", White	EACH	24.93	12	120	3.02

**POLYCARBONATE FLAT GRIP TONG**

Can be used to serve hot or cold food.



PLFTG006BG



PLFTG006BK



PLFTG006CL



PLFTG006GR



PLFTG006RD



PLFTG006WH

Color Coded



POLYCARBONATE



ITEM	DESCRIPTION	U/M	WEIGHT GROSS lbs	INNER PACK	MASTER PACK	CU. FT.
PLFTG006BG	6" x 1⅝" 1", Beige	EACH	9.37	12	120	1.01
PLFTG006BK	6" x 1⅝" 1", Black	EACH	9.37	12	120	1.01
PLFTG006CL	6" x 1⅝" 1", Clear	EACH	9.37	12	120	1.01
PLFTG006GR	6" x 1⅝" 1", Green	EACH	9.37	12	120	1.01
PLFTG006RD	6" x 1⅝" 1", Red	EACH	9.37	12	120	1.01
PLFTG006WH	6" x 1⅝" 1", White	EACH	9.37	12	120	1.01
PLFTG009BG	9" x 2½" x 1⅝", Beige	EACH	18.74	12	120	1.66
PLFTG009BK	9" x 2½" x 1⅝", Black	EACH	18.74	12	120	1.66
PLFTG009CL	9" x 2½" x 1⅝", Clear	EACH	18.74	12	120	1.66
PLFTG009GR	9" x 2½" x 1⅝", Green	EACH	18.74	12	120	1.66
PLFTG009RD	9" x 2½" x 1⅝", Red	EACH	18.74	12	120	1.66
PLFTG009WH	9" x 2½" x 1⅝", White	EACH	18.74	12	120	1.66
PLFTG012BG	12" x 2½" x 1¾", Beige	EACH	38.14	12	120	3.02
PLFTG012BK	12" x 2½" x 1¾", Black	EACH	38.14	12	120	3.02
PLFTG012CL	12" x 2½" x 1¾", Clear	EACH	38.14	12	120	3.02
PLFTG012GR	12" x 2½" x 1¾", Green	EACH	38.14	12	120	3.02
PLFTG012RD	12" x 2½" x 1¾", Red	EACH	38.14	12	120	3.02
PLFTG012WH	12" x 2½" x 1¾", White	EACH	38.14	12	120	3.02

## SPRING TONG

Shaped in a rigid form allows flexibility for heavy use.



STAINLESS STEEL

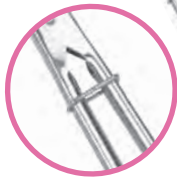

SLTHUT012



SLTHUT107



SLTHUT212

ITEM	DESCRIPTION	U/M	WEIGHT GROSS lbs	INNER PACK	MASTER PACK	CU. FT.
<b>Standard</b>						
SLTHUT010	10" x 1 $\frac{3}{16}$ " x 1 $\frac{3}{8}$ " Flat Spring, Locking Ring	EACH	19.80	12	144	1.42
SLTHUT012	12" x 1 $\frac{1}{4}$ " x 1 $\frac{3}{8}$ " Flat Spring, Locking Ring	EACH	25.96	12	144	1.70
SLTHUT016	16" x 1 $\frac{3}{16}$ " x 1 $\frac{3}{8}$ " Flat Spring, Locking Ring	EACH	44.88	12	144	2.18
<b>Heavy Duty (0.9mm - 1.0mm)</b>						
SLTHUT107	7" x 1 $\frac{3}{8}$ " x 1 $\frac{1}{4}$ " Coiled Spring, Heavy Duty, 0.9mm	EACH	25.31	12	144	1.13
SLTHUT110	10" x 1 $\frac{3}{16}$ " x 1 $\frac{3}{8}$ " Flat Spring, Locking Ring, Heavy Duty, 1 mm	EACH	40.79	12	144	1.36
SLTHUT112	12" x 1 $\frac{3}{16}$ " x 1 $\frac{3}{8}$ " Flat Spring, Locking Ring, Heavy Duty, 1 mm	EACH	55.12	12	144	1.63
SLTHUT116	16" x 1 $\frac{3}{16}$ " x 1 $\frac{3}{8}$ " Flat Spring, Locking Ring, Heavy Duty, 1 mm	EACH	67.24	12	144	2.19
<b>Extra Heavy Duty (1.2mm)</b>						
SLTHUT210	9 $\frac{1}{2}$ " x 1 $\frac{1}{6}$ " x 1" Coiled Spring, Extra Heavy Duty, 1.2 mm	EACH	35.27	12	144	1.56
SLTHUT212	12" x 1 $\frac{1}{4}$ " x 1 $\frac{3}{8}$ " Coiled Spring, Extra Heavy Duty, 1.2 mm	EACH	50.71	12	120	1.65
SLTHUT216	16" x 1 $\frac{3}{16}$ " x 1 $\frac{3}{8}$ " Coiled Spring, Extra Heavy Duty, 1.2 mm	EACH	30.86	12	96	1.89

## EGG RING

Contain the egg in a perfect shape while it cooks.



STAINLESS STEEL

SLER0601R



SLER0401S



Frying Pan Sold Separately

ITEM	DESCRIPTION	U/M	WEIGHT GROSS lbs	INNER PACK	MASTER PACK	CU. FT.
<b>Round</b>						
SLER0301R	3" x 5 $\frac{1}{8}$ " Diameter	EACH	19.67	12	216	1.20
SLER0401R	4" x 5 $\frac{1}{8}$ " Diameter	EACH	23.96	12	216	1.27
SLER0501R	5" x 5 $\frac{1}{8}$ " Diameter	EACH	26.34	12	216	1.31
SLER0601R	6" x 5 $\frac{1}{8}$ " Diameter	EACH	32.05	12	216	1.34
<b>Square</b>						
SLER0401S	4" x 4" x 5" Square	EACH	37.29	12	216	1.38



**UTILITY TONG**

Safely handle food touch free to keep it sanitary.



ITEM	DESCRIPTION	U/M	WEIGHT GROSS lbs	INNER PACK	MASTER PACK	CU. FT.
SLTG309	9" x 3½" x 1¼" Hamburger Tong	EACH	21.73	12	120	0.69
SLTG310	10½" x 6¾" x 1⅜" Hamburger Tong	EACH	24.38	12	120	1.98
SLTG407	7½" x 3⅞" x 1¼" Cake Tong	EACH	19.88	12	120	0.76
SLTG408	8⅝" x 3⅞" x 1½" Cake Tong	EACH	20.15	12	120	1.18
SLTG607	7½" x 2⅞" x 1⅝" Pastry Tong	EACH	20.41	12	120	0.77
SLTG608	9" x 3½" x 1⅝" Pastry Tong	EACH	19.62	12	120	0.69
SLTG706	6" x 3⅜" x 1⅜" Pom Tong	EACH	14.59	12	120	0.31
SLTG709	9" x 4⅞" x ⅞" Pom Tong	EACH	20.15	12	120	0.64
SLTG712	12" x 4¾" x 1¼" Pom Tong	EACH	38.67	12	120	0.90
SLSR010	10" x 3½" x 1½" Scissor Tong	EACH	37.04	12	144	2.11
SLSR015	15" x 3¼" x 1⅞" Scissor Tong	EACH	56.00	12	144	3.33
SLBT075	7½" x 3⅞" x ⅞" Bread Tong	DOZEN	20.94	1	25	0.38
SLBT095	9½" x 4" x 1" Bread Tong	DOZEN	26.46	1	25	0.48
SLBT115	11½" x 3¾" x ⅞" Bread Tong	DOZEN	37.48	1	12	0.58
SLIT007	6¼" x 1⅜" x 1" Ice Tong	EACH	19.00	24	240	0.62
SLTG208	8" x 1⅞" x 2⅜" Spaghetti Tong	EACH	35.60	12	288	1.57
SLTTMN008	8" x 2¾" x 1⅜" Multi-Serving Spoon	EACH	35.71	12	240	3.30
SLTTBN024	9½" x 2¾" x 1⅞" Barbeque Tong	EACH	34.10	12	360	3.18



**NON-SLIP LOCKING UTILITY TONG**

Non-slip silicone tips and grip with locking clip.



ITEM	DESCRIPTION	U/M	WEIGHT GROSS lbs	INNER PACK	MASTER PACK	CU. FT.
SLTHUT610	9" x 1⅜" x 1½", Silicone Tips and Grip	EACH	24.60	12	72	1.25
SLTHUT612	12" x 1⅜" x 1½", Silicone Tips and Grip	EACH	29.92	12	72	1.56





SLTHUT507

**NON-SLIP UTILITY TONG**

Non-slip silicone tips with sliding locking ring.



ITEM	DESCRIPTION	U/M	WEIGHT GROSS lbs	INNER PACK	MASTER PACK	CU. FT.
SLTHUT507	7" Utility Tong, Silicone Tips	EACH	15.40	24	144	0.92



SLTG810B



SLTG812Y



SLTG816R



SLTG1600B

**TONG WITH NON-SLIP HANDLE**

Stainless steel tong with coated handles are ideal for touch free, safe and sanitary food service.



ITEM	DESCRIPTION	U/M	WEIGHT GROSS lbs	INNER PACK	MASTER PACK	CU. FT.
SLTG810B	10" x 4 <sup>5</sup> / <sub>8</sub> " x 1 <sup>1</sup> / <sub>2</sub> ", Blue	EACH	39.68	12	120	1.63
SLTG810G	10" x 4 <sup>5</sup> / <sub>8</sub> " x 1 <sup>1</sup> / <sub>2</sub> ", Green	EACH	39.68	12	120	1.63
SLTG810K	10" x 4 <sup>5</sup> / <sub>8</sub> " x 1 <sup>1</sup> / <sub>2</sub> ", Black	EACH	39.68	12	120	1.63
SLTG810R	10" x 4 <sup>5</sup> / <sub>8</sub> " x 1 <sup>1</sup> / <sub>2</sub> ", Red	EACH	39.68	12	120	1.63
SLTG810Y	10" x 4 <sup>5</sup> / <sub>8</sub> " x 1 <sup>1</sup> / <sub>2</sub> ", Yellow	EACH	39.68	12	120	1.63
SLTG812B	12" x 7 <sup>3</sup> / <sub>4</sub> " x 1 <sup>1</sup> / <sub>2</sub> ", Blue	EACH	46.30	12	120	2.03
SLTG812G	12" x 7 <sup>3</sup> / <sub>4</sub> " x 1 <sup>1</sup> / <sub>2</sub> ", Green	EACH	46.30	12	120	2.03
SLTG812K	12" x 7 <sup>3</sup> / <sub>4</sub> " x 1 <sup>1</sup> / <sub>2</sub> ", Black	EACH	46.30	12	120	2.03
SLTG812R	12" x 7 <sup>3</sup> / <sub>4</sub> " x 1 <sup>1</sup> / <sub>2</sub> ", Red	EACH	46.30	12	120	2.03
SLTG812Y	12" x 7 <sup>3</sup> / <sub>4</sub> " x 1 <sup>1</sup> / <sub>2</sub> ", Yellow	EACH	46.30	12	120	2.03
SLTG816B	16" x 6 <sup>1</sup> / <sub>2</sub> " x 1 <sup>1</sup> / <sub>2</sub> ", Blue	EACH	62.70	12	120	2.61
SLTG816G	16" x 6 <sup>1</sup> / <sub>2</sub> " x 1 <sup>1</sup> / <sub>2</sub> ", Green	EACH	62.70	12	120	2.61
SLTG816K	16" x 6 <sup>1</sup> / <sub>2</sub> " x 1 <sup>1</sup> / <sub>2</sub> ", Black	EACH	62.70	12	120	2.61
SLTG816R	16" x 6 <sup>1</sup> / <sub>2</sub> " x 1 <sup>1</sup> / <sub>2</sub> ", Red	EACH	62.70	12	120	2.61
SLTG816Y	16" x 6 <sup>1</sup> / <sub>2</sub> " x 1 <sup>1</sup> / <sub>2</sub> ", Yellow	EACH	62.70	12	120	2.61
SLTG1600B	16" x 5" x 1 <sup>1</sup> / <sub>2</sub> " Extra Heavy Duty Tong, Black	EACH	84.70	12	120	3.30
SLTG1600Y	16" x 5" x 1 <sup>1</sup> / <sub>2</sub> " Extra Heavy Duty Tong, Yellow	EACH	84.70	12	120	3.30



**STEAK WEIGHT and MEAT PRESS**

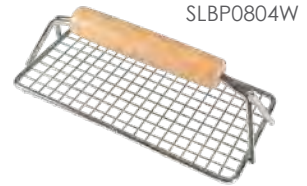

ITEM	DESCRIPTION	U/M	WEIGHT GROSS lbs	INNER PACK	MASTER PACK	CU. FT.
<b>Steak Weight</b>						
SLKSW008	4 1/4" x 8 1/4" x 2 5/8" Aluminum	EACH	14.42	1	12	1.01
SLKSW108	4 1/8" x 8 1/4" x 2 1/2" Cast Iron	EACH	25.91	1	12	1.13
SLKSW095	5" x 9" x 3" Cast Iron	EACH	35.98	1	12	1.25
<b>Meat Press</b>						
SLBP0804W	8" x 4" Chrome Plated Bacon Press, Wood Handle.	EACH	31.97	4	48	2.48
ALHP004A	4 1/2" Hamburger Press, Adjustable From 1/8" to 3/8", Aluminum	EACH	44.53	12	36	2.97

**MEAT TENDERIZER**

Easy to clean aluminum body. Dual faces for coarse and fine cut options. Stable handle on cast aluminum head.



ITEM	DESCRIPTION	U/M	WEIGHT GROSS lbs	INNER PACK	MASTER PACK	CU. FT.
ALMH001	9 3/4" x 2 3/4" x 1 1/2"	EACH	35.27	12	36	0.74
ALMH002	9 7/8" x 2 1/8" x 2"	EACH	48.50	12	36	1.06
ALMT002	2 sided 10 1/8" x 2 3/4" x 3 1/8"	EACH	44.09	12	48	1.35
ALMTW001	2 sided w/ Wooden Handle 13" x 3" x 3"	EACH	55.12	6	48	2.27



**POTATO RICER**

Process potatoes by squeezing handles together to make perfect mashed potato effortlessly.



ITEM	DESCRIPTION	U/M	WEIGHT GROSS lbs	INNER PACK	MASTER PACK	CU. FT.
SLPR009	10" x 8" x 4"	EACH	25.30	1	24	3.00
SLPR016	10 3/4" x 4" x 4"	EACH	77.16	1	24	8.10



## TURNER

Fit for versatile needs in kitchen. Easy to wipe and clean.



ITEM	DESCRIPTION	BLADE LENGTH	BLADE WIDTH	OVERALL LENGTH	U/M	GROSS WEIGHT lbs	INNER PACK	MASTER PACK	CU. FT.
SLFT065P	Flexible Turner, Plastic Handle Perforated	8½"	3"	15"	EACH	53.90	12	120	2.17
SLFT065S	Flexible Turner, Plastic Handle	8½"	3"	15"	EACH	55.12	12	120	2.17
SLHT064P	Hamburger Turner, Plastic Handle	5¼"	3"	12"	EACH	52.69	12	120	1.52
SLTWBT006	6" Round Blade Turner	6½"	2 7⁄8"	12½"	EACH	30.80	12	72	0.96
SLTWBT010	10" Round Blade Turner Blade: 10" x 3" Handle: 4½" x 1" x ¾"	8"	3"	14½"	EACH	37.48	12	72	1.05
SLTWBT075	7½" Straight Blade Turner Blade: 8" x 3" Handle: 4½" x 1" x ¾"	6"	3"	12½"	EACH	30.64	12	72	0.96
SLTWBT110	10" Perforated Blade Turner- Hole: 3⁄8" Blade: 10" x 3" Handle: 4½" x 1" x ¾"	8"	3"	14½"	EACH	37.08	12	72	1.05
SLTWBT210	10" Solid Blade Turner Blade: 10" x 3" Handle: 4½" x 1" x ¾"	8"	3"	14½"	EACH	53.13	12	120	1.64
SLTWHT003	3" x 5" Hamburger Turner	5"	2 7⁄8"	11½"	EACH	31.97	12	72	0.68
SLTWHT004	4" x 8" x 15" Oversize Blade	8"	4"	15½"	EACH	30.86	6	36	0.98
SLTWHT005	4" x 5" Hamburger Turner	5½"	4½"	13½"	EACH	22.05	6	24	0.63
SLTWPS003	3" x 5" Pizza Square Server	4¼"	2¼"	10½"	EACH	36.00	12	180	1.92
SLTWHT008	4" x 8" x 20" Pizza Square Server	9"	4¼"	25½"	EACH	32.75	6	24	1.30
SLTWST010	10" Solid Turner, Long	8"	3"	21"	EACH	33.07	12	48	1.14
SLTWPT003	6" Pancake Turner, Slotted	6"	3"	14"	EACH	29.48	24	120	0.47
SLTWPT003S	6" Pancake Turner, Solid	6"	3"	14"	EACH	35.05	12	144	0.79



**SPATULA**

Offset spatula is flexible and strong. Offset wood handle for control and hard to reach places.

ITEM	DESCRIPTION	U/M	WEIGHT GROSS lbs	INNER PACK	MASTER PACK	CU. FT.
SLPSP010C	9½" Blade Size 14⅜" x 1½" x 2"	EACH	44.00	12	144	1.42



SLPSP010C

**ICING SPATULA**

Spatula is flexible and strong. Spreads icing smoothly and evenly. Comes with wood handle.

ITEM	DESCRIPTION	U/M	WEIGHT GROSS lbs	INNER PACK	MASTER PACK	CU. FT.
SLPSP008	8" Blade Size 12¾" x 1⅜" x ½"	EACH	28.06	24	144	0.59
SLPSP010	10" Blade Size 14¾" x 1⅜" x ½"	EACH	28.60	24	144	0.67
SLPSP012	12" Blade Size 16¾" x 1⅜" x ½"	EACH	30.86	24	144	0.75
SLPSP014	14" Blade Size 18¾" x 1⅜" x ½"	EACH	39.68	24	144	0.83



SLPSP008

**POT FORK**

Wooden handles are tightly secured onto forks with intensified rivets. Long handle for easy use and safety.

ITEM	DESCRIPTION	U/M	WEIGHT GROSS lbs	INNER PACK	MASTER PACK	CU. FT.
SLTWPF013	13" x 1" x ⅝"	EACH	30.86	12	120	0.81
SLTWPF021	21" x 1" x ⅝"	EACH	28.66	12	72	0.76



SLTWPF013

SLTWPF021

**SANDWICH SPREADER**

Serrated blade for various textures of sandwich spread. Stainless steel blade with plastic or wood handle and rounded top to avoid tearing.

ITEM	DESCRIPTION	U/M	WEIGHT GROSS lbs	INNER PACK	MASTER PACK	CU. FT.
SLWS004P	4¼" x 1¼" Blade size with Plastic Handle 9½" x 1⅜" x ¾"	EACH	23.04	12	120	0.64
SLTWBS007	4" Blade size with Wood Handle, 7⅞" x 1⅝" x ⅝"	EACH	26.46	12	240	0.57



SLWS004P

SLTWBS007

**STAINLESS STEEL SKEWER**

Food glides easily through the stainless steel pointed edge. Available in tear drop or round hoop handles. Dishwasher safe.



ITEM	DESCRIPTION	U/M	WEIGHT GROSS lbs	INNER PACK	MASTER PACK	CU. FT.
<b>Tear Drop Handle</b>						
SLOK008	8" Oval Skewers	DOZEN	14.50	4	24	0.44
SLOK010	10" Oval Skewers	DOZEN	18.00	4	24	0.49
SLOK012	12" Oval Skewers	DOZEN	21.50	4	24	0.62
<b>Round Hoop Handle</b>						
SLRK008	8" Round Skewers	DOZEN	12.00	4	24	0.33
SLRK010	10" Round Skewers	DOZEN	12.50	4	24	0.22
SLRK012	12" Round Skewers	DOZEN	14.50	4	24	0.25



SLOK

SLRK

## PLASTIC SCRAPER

Light and flexible plastic scraper. It can be used for mixing, spreading or scraping. Easy to clean.



ITEM	DESCRIPTION	U/M	WEIGHT GROSS lbs	INNER PACK	MASTER PACK	CU. FT.
<b>Max Temp 185° F - Plastic Blade</b>						
PLSP010	10" x 2 1/8" x 1/2"	EACH	17.64	12	144	1.15
PLSP014	14" x 2 7/8" x 5/8"	EACH	33.00	12	144	1.96
PLSP016	16" x 3 1/8" x 4/5"	EACH	35.20	12	144	2.32
OW364	9 1/2" x 1 3/8" x 3/8", 3" Blade size	EACH	21.83	24	288	0.95
<b>Max Temp 500° F - Silicon Blade</b>						
PLSP010HR	10" x 2 1/8" x 1/2"	EACH	19.80	12	144	2.36
PLSP014HR	14" x 2 5/8" x 3/5"	EACH	46.20	12	144	3.39
PLSP016HR	16" x 3 1/8" x 4/5"	EACH	49.94	12	144	3.72
<b>Max Temp 500° F - Spoon Shape Silicon Blade</b>						
PLSP010SHR	10" x 2 1/8" x 1/2"	EACH	26.40	12	144	3.42
PLSP014SHR	14" x 2 5/8" x 3/5"	EACH	50.60	12	144	4.64
PLSP016SHR	16" x 3 1/8" x 4/5"	EACH	54.56	12	144	5.73



## SCRAPER

Flexible satin finish stainless steel blade with plastic or wood handle. Glides on flat surface area to divide or scrape dough.



ITEM	DESCRIPTION	U/M	WEIGHT GROSS lbs	INNER PACK	MASTER PACK	CU. FT.
SLDS060P	6" x 4" x 3/4" Plastic Handle	EACH	48.50	12	120	1.09
SLTWDS006	6" x 4" x 1/2" Wood Handle	EACH	30.86	12	72	0.61
SLTHDS005	5 1/4" x 4 1/4" x 1 3/8" Stainless Steel Handle	EACH	29.76	12	72	1.07
SLPS004P	3" Blade 9 3/4" x 3 1/8" x 7/8" Plastic Handle 4" x 3" Blade Size	EACH	32.49	12	120	0.84
SLTWBS003	3" Blade 8 3/4" x 3 3/16" x 1 1/2" Wood Handle 4" x 3" Blade Size	EACH	33.07	12	144	0.67
SLTWBS004	4" Blade 8 1/2" x 4" x 7/8" Wood Handle 4 1/2" x 4" Blade Size	EACH	37.48	12	96	0.63





SLMB201 ~ SLMB209

### HEAVY DUTY STAINLESS STEEL MIXING BOWLS - (0.8 mm)

Flat base for exceptional balance while mixing. Material endures heavy usage with curved lip for secure handling.



ITEM	DESCRIPTION	U/M	WEIGHT GROSS lbs	INNER PACK	MASTER PACK	CU. FT.
SLMB201	¾ qt, 6½" Diameter x 2¼" Height	EACH	58.00	24	144	0.96
SLMB202	1½ qt, 7⅞" Diameter x 2¾" Height	EACH	61.00	24	96	1.13
SLMB203	3 qt, 9½" Diameter x 3⅝" Height	EACH	66.00	24	72	1.10
SLMB204	4 qt, 11" Diameter x 3½" Height	EACH	77.62	24	72	1.19
SLMB205	5 qt, 11⅞" Diameter x 4" Height	EACH	34.00	12	24	1.16
SLMB206	8 qt, 13⅞" Diameter x 4⅞" Height	EACH	46.00	12	24	1.64
SLMB207	13 qt, 16⅜" Diameter x 5½" Height	EACH	67.00	12	24	2.72
SLMB208	16 qt, 17⅞" Diameter x 5⅝" Height	EACH	76.70	12	24	3.09
SLMB209	20 qt, 19" Diameter x 5⅞" Height	EACH	41.70	12	12	1.71



SLMB001 ~ SLMB030

### ECONOMY STAINLESS STEEL MIXING BOWLS

Polished stainless steel mixing bowl helps with preparation of food. Mix salads, sauces, cookie dough and many others in these versatile bowls. Medium weight for easy mobility and handling.



ITEM	DESCRIPTION	U/M	WEIGHT GROSS lbs	INNER PACK	MASTER PACK	CU. FT.
SLMB001	¾ qt, 13⅞" Diameter x 2⅞" Height	EACH	29.76	24	144	0.94
SLMB002	1½ qt, 8" Diameter x 2⅝" Height	EACH	38.76	24	144	1.54
SLMB003	3 qt, 9⅞" Diameter x 3½" Height	EACH	40.59	24	96	1.68
SLMB004	4 qt, 10⅞" Diameter x 3½" Height	EACH	36.66	24	72	1.50
SLMB005	5 qt, 11⅞" Diameter x 4" Height	EACH	43.08	24	72	1.96
SLMB006	8 qt, 13½" Diameter x 5" Height	EACH	20.86	12	24	1.85
SLMB007	13 qt, 16¼" Diameter x 4¾" Height	EACH	34.48	12	24	2.19
SLMB008	16 qt, 17⅜" Diameter x 5⅝" Height	EACH	21.16	12	12	1.34
SLMB009	20 qt, 18⅞" Diameter x 6" Height	EACH	21.12	12	12	1.70
SLMB030	30 qt, 22⅞" Diameter x 7⅞" Height	EACH	39.51	12	12	2.91

## COLANDER (HEAVY DUTY)

Easy to clean drain perforations. Bolted handles with stable base for steady mixing, rinsing, and transporting.



ITEM	DESCRIPTION	U/M	WEIGHT GROSS lbs	INNER PACK	MASTER PACK	CU. FT.
ALHDCO001	8 qt w/ Base & Handle, 12 $\frac{3}{8}$ " Diameter x 7 $\frac{1}{2}$ " Height. Handle: 1 $\frac{1}{4}$ ", Bottom Diameter: 9 $\frac{1}{2}$ "	EACH	9.61	4	4	1.57
ALHDCO002	12 qt w/ Base & Handle, 15" Diameter x 7 $\frac{3}{4}$ " Height. Handle: 1 $\frac{3}{4}$ ", Bottom Diameter: 10 $\frac{3}{4}$ "	EACH	12.02	4	4	2.47
ALHDCO003	16 qt w/ Base & Handle, 16 $\frac{1}{2}$ " Diameter x 9 $\frac{5}{8}$ " Height. Handle: 1 $\frac{3}{4}$ ", Bottom Diameter: 11 $\frac{1}{2}$ "	EACH	15.83	4	4	3.70
<b>Heavy Duty</b>						
ALHDCO101	12 qt w/ Base & Handle, 15 $\frac{1}{4}$ " Diameter x 7 $\frac{1}{4}$ " Height. Handle: 1", Bottom Diameter: 11 $\frac{1}{2}$ "	EACH	18.54	4	4	2.45
ALHDCO102	16 qt w/ Base & Handle, 16 $\frac{1}{4}$ " Diameter x 8" Height. Handle: 1 $\frac{1}{2}$ ", Bottom Diameter: 11 $\frac{5}{8}$ "	EACH	18.74	4	4	2.79
ALSAC001	12 qt, 12 $\frac{7}{8}$ " Diameter x 5 $\frac{5}{8}$ " Height	EACH	12.02	1	10	1.08
ALSAC002	15 qt, 16 $\frac{1}{4}$ " Diameter x 7 $\frac{1}{2}$ " Height	EACH	20.94	1	10	2.52



ALHDCO001 ~ ALHDCO003



ALHDCO101 ~ ALHDCO102



ALSAC001 ~ ALSAC002

## COLANDER

Free standing colander with mirror finish for hands-free draining. Ideal for rinsing vegetables or pasta.



ITEM	DESCRIPTION	Hole Size	U/M	WEIGHT GROSS lbs	INNER PACK	MASTER PACK	CU. FT.
<b>Colanders with Handles</b>							
SLIL001	3 qt, 9 $\frac{1}{2}$ " Diameter x 4 $\frac{1}{4}$ " Height, Handle: 1 $\frac{1}{4}$ ", Bottom Diameter: 5 $\frac{1}{8}$ "	2.0 mm	EACH	35.50	12	48	3.66
SLIL002	5 qt, 11 $\frac{3}{4}$ " Diameter x 4 $\frac{3}{4}$ " Height, Handle: 1 $\frac{5}{8}$ ", Bottom Diameter: 6 $\frac{1}{4}$ "	2.0 mm	EACH	23.15	6	24	3.66
SLIL003	8 qt, 13 $\frac{1}{2}$ " Diameter x 6 $\frac{3}{8}$ " Height, Handle: 1 $\frac{1}{2}$ ", Bottom Diameter: 7 $\frac{1}{8}$ "	2.0 mm	EACH	14.33	6	12	3.65
SLIL004	13 qt, 15 $\frac{3}{4}$ " Diameter x 6" Height, Handle: 1 $\frac{3}{4}$ ", Bottom Diameter: 7 $\frac{1}{8}$ "	2.0 mm	EACH	19.84	6	12	3.60
<b>Colander - No Handle</b>							
SLCIL11L	11", 11" Diameter x 3 $\frac{3}{8}$ " Height	4.5 mm	EACH	21.60	1	24	0.83
SLCIL11S	11", 11" Diameter x 3 $\frac{3}{8}$ " Height	2.0 mm	EACH	21.60	1	24	0.83
SLCIL13L	13", 13" Diameter x 4 $\frac{1}{2}$ " Height	4.5 mm	EACH	31.97	1	24	1.32
SLCIL13S	13", 13" Diameter x 4 $\frac{1}{2}$ " Height	2.0 mm	EACH	31.97	1	24	1.32
SLCIL15L	15", 15 $\frac{1}{4}$ " Diameter x 5 $\frac{1}{2}$ " Height	4.5 mm	EACH	23.81	1	12	1.57
SLCIL15S	15", 15 $\frac{1}{4}$ " Diameter x 5 $\frac{1}{2}$ " Height	2.0 mm	EACH	23.81	1	12	1.57
<b>Perforated Mixing Bowl</b>							
SLMBP075	$\frac{3}{4}$ qt, 6 $\frac{3}{8}$ " Diameter x 1 $\frac{5}{8}$ " Height	3.0 mm	EACH	26.40	24	144	0.78
SLMBP150	1 $\frac{1}{2}$ qt, 8" Diameter x 8" Height	3.0 mm	EACH	42.90	24	96	1.25
SLMBP200	2 qt, 8 $\frac{3}{4}$ " Diameter x 8 $\frac{1}{4}$ " Height	3.0 mm	EACH	44.00	24	96	1.46



SLIL001



SLCIL11L, SLCIL13L, SLCIL15L



SLMBP075

## HEAVY DUTY POLAR BASIN

Slight contoured neck and lip for easy handling. Dent resistant.



ITEM	DESCRIPTION	U/M	WEIGHT GROSS lbs	INNER PACK	MASTER PACK	CU. FT.
SLPH002	12 qt, 17" Diameter x 5½" Height	EACH	28.50	1	10	1.82
SLPH003	16 qt, 18" Diameter x 5½" Height	EACH	35.80	1	10	2.32
SLPH004	22 qt, 21" Diameter x 6¼" Height	EACH	40.00	1	10	3.00
SLPH005	28 qt, 23" Diameter x 6¾" Height	EACH	46.00	1	10	3.55
SLPH007	44 qt, 26" Diameter x 7¾" Height	EACH	57.85	1	10	4.09



SLPH002

## WATER LADLE

Welded handle. Rust-free.



ITEM	DESCRIPTION	U/M	WEIGHT GROSS lbs	INNER PACK	MASTER PACK	CU. FT.
SLWL001	2 qt, 8¼" Diameter x 5½" Height	EACH	51.81	1	80	4.40



SLWL001

## ROUND WASH BASKET

Perforated plastic colander for cleaning or storing produce and other food items. Easy to clean and can be stacked for storage. Comes in random red or blue colors.



ITEM	DESCRIPTION	U/M	WEIGHT GROSS lbs	INNER PACK	MASTER PACK	CU. FT.
PLWB001	12½" Diameter x 4¼" Height	EACH	13.89	1	35	2.40
PLWB002	11½" Diameter x 3¾" Height	EACH	11.02	1	35	1.92
PLWB003	10" Diameter x 3½" Height	EACH	13.23	1	60	2.21
PLWB004	9" Diameter x 3¾" Height	EACH	11.02	1	60	1.57
PLWB005	8" Diameter x 2¾" Height	EACH	7.72	1	60	0.94



PLWB001 ~ PLWB005

## ROUND COLANDER

Perforated plastic colander with grip. Stackable for neat storage. Comes in random red or blue colors.



ITEM	DESCRIPTION	U/M	WEIGHT GROSS lbs	INNER PACK	MASTER PACK	CU. FT.
PLFP001	18½" Diameter x 5¾" Height with Grip	EACH	28.66	1	30	4.35



PLFP001

**Durable!**



PLFB001 ~ PLFB005

## SQUARE COLANDER

Perforated surface for aerating and straining vegetables or other produce. Easy to clean surface, durable and stackable for storage. Comes in random red or blue colors.



ITEM	DESCRIPTION	U/M	WEIGHT GROSS lbs	INNER PACK	MASTER PACK	CU. FT.
PLFB001	21¾" x 17" x 5"	EACH	23.73	1	20	3.91
PLFB002	19¾" x 15½" x 4½"	EACH	19.14	1	20	3.05
PLFB003	18" x 13¾" x 4½"	EACH	17.72	1	20	2.13
PLFB004	15¼" x 12¼" x 3½"	EACH	10.89	1	20	1.24
PLFB005	14¼" x 11¼" x 3"	EACH	8.80	1	20	1.08



Epoxy Finish



SLWPF010



SLWPP110

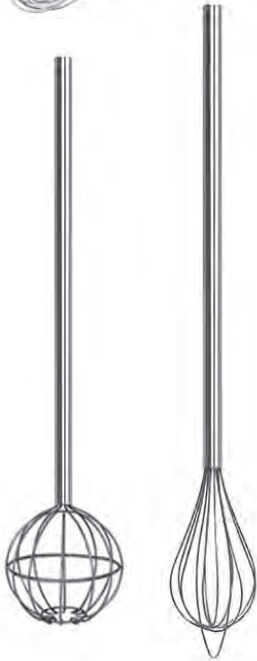

SLKW048

SLMW040



SLKCP008



SLKCP208



SLKCP208R

## WHIP

Made for whipping eggs, egg whites and other heavy mixing. Stainless steel wire and handle.



ITEM	DESCRIPTION	U/M	WEIGHT GROSS lbs	INNER PACK	MASTER PACK	CU. FT.
<b>French</b>						
OW362	9¾" French Whip	EACH	50.71	12	240	4.12
SLWPF010	10" French Whip	EACH	28.00	12	60	1.34
SLWPF012	12" French Whip	EACH	32.50	12	60	1.48
SLWPF014	14" French Whip	EACH	30.86	12	60	1.85
SLWPF016	16" French Whip	EACH	33.73	12	60	2.28
SLWPF018	18" French Whip	EACH	37.92	12	60	2.65
SLWPF020	20" French Whip	EACH	42.99	12	60	2.89
SLWPF022	22" French Whip	EACH	46.30	12	60	3.16
<b>Piano</b>						
SLWPP110	10" Piano Whip	EACH	39.24	12	120	2.37
SLWPP112	12" Piano Whip	EACH	41.89	12	120	2.73
SLWPP114	14" Piano Whip	EACH	45.00	12	120	3.09
SLWPP116	16" Piano Whip	EACH	26.01	12	60	2.07
SLWPP118	18" Piano Whip	EACH	28.22	12	60	2.43

## DOME AND TEAR DROP SHADE WHIP

Long handle fits for deep mixer bowl application.



ITEM	DESCRIPTION	U/M	WEIGHT GROSS lbs	INNER PACK	MASTER PACK	CU. FT.
SLKW048	48" x 8¾" Diameter Dome Shape	EACH	7.72	1	2	2.15
SLMW040	40" x 5½" Diameter Tear Drop	EACH	5.52	1	2	0.79

## CHINA CAP

Pointed mesh securely framed by handle. Choose from coarse mesh or fine mesh. Mesh lining properly serves soups, purees, bisques and sauces.



ITEM	DESCRIPTION	U/M	WEIGHT GROSS lbs	INNER PACK	MASTER PACK	CU. FT.
<b>Coarse</b>						
SLKCP008	2 qt, 8" Diameter x 18½" Length	EACH	18.08	1	12	2.05
SLKCP010	4 qt, 10" Diameter x 20½" Length	EACH	24.25	1	12	3.12
SLKCP012	6 qt, 12" Diameter x 22" Length	EACH	27.56	1	12	4.57
<b>Fine</b>						
SLKCP108	2 qt, 8" Diameter x 18½" Length	EACH	18.08	1	12	2.05
SLKCP110	4 qt, 10" Diameter x 20½" Length	EACH	24.25	1	12	3.12
SLKCP112	6 qt, 12" Diameter x 21½" Length	EACH	27.56	1	12	4.57

## BOUILLON STRAINERS

Choose from fine mesh or reinforced fine mesh. Pan hook provides stability when in use. Mesh lining properly serves soups, purees, bisques and sauces.



ITEM	DESCRIPTION	U/M	WEIGHT GROSS lbs	INNER PACK	MASTER PACK	CU. FT.
SLKCP208	1½ qt, 8" Diameter x 18" Length, Fine Mesh	EACH	14.33	1	12	1.47
SLKCP210	3 qt, 10" Diameter x 19¾" Length, Fine Mesh	EACH	17.64	1	12	2.50
<b>Reinforced</b>						
SLKCP208R	1½ qt, 8" Diameter x 18" Length, Fine Mesh	EACH	17.64	1	12	1.89
SLKCP210R	3 qt, 10" Diameter x 19¾" Length, Fine Mesh	EACH	23.81	1	12	2.80



**STRAINER**

Fine tin single mesh wires and framework with enclosed wooden handle. Medium tin single mesh wires and framework with enclosed wooden handle.

ITEM	DESCRIPTION	U/M	WEIGHT GROSS lbs	INNER PACK	MASTER PACK	CU. FT.
<b>Fine</b>						
SLSTN3106	6" Single - 6" Diameter x 3 $\frac{3}{8}$ " Height, Handle: 6 $\frac{3}{4}$ "	EACH	27.25	12	48	1.60
SLSTN3108	8" Single - 8" Diameter x 4 $\frac{5}{8}$ " Height, Handle: 6"	EACH	25.26	12	48	2.63
SLSTN3110	10" Single - 10" Diameter x 5 $\frac{1}{2}$ " Height, Handle: 13"	EACH	16.42	6	24	4.32
SLSTN3206	6" Double - 6" Diameter x 3 $\frac{3}{8}$ " Height, Handle: 6 $\frac{3}{4}$ "	EACH	29.45	12	48	1.60
SLSTN3208	8" Double - 8" Diameter x 4 $\frac{5}{8}$ " Height, Handle: 6"	EACH	34.48	12	48	2.63
SLSTN3210	10" Double - 10" Diameter x 5 $\frac{1}{2}$ " Height, Handle: 13"	EACH	17.90	6	24	4.32
<b>Medium</b>						
SLSTN3306	6" Single - 6" Diameter x 3 $\frac{3}{8}$ " Height, Handle: 6 $\frac{3}{4}$ "	EACH	27.25	12	48	1.60
SLSTN3308	8" Single - 8" Diameter x 4 $\frac{5}{8}$ " Height, Handle: 6"	EACH	28.40	12	48	2.63
SLSTN3310	10" Single - 10" Diameter x 5 $\frac{1}{2}$ " Height, Handle: 13"	EACH	25.26	6	24	4.32
SLSTN3406	6" Double - 6" Diameter x 3 $\frac{3}{8}$ " Height, Handle: 6 $\frac{3}{4}$ "	EACH	19.18	12	48	1.60
SLSTN3408	8" Double - 8" Diameter x 4 $\frac{5}{8}$ " Height, Handle: 6"	EACH	29.45	6	48	2.63
SLSTN3410	10" Double - 10" Diameter x 5 $\frac{1}{2}$ " Height, Handle: 13"	EACH	35.85	6	24	4.32



**STRAINER**

Stainless steel single mesh wires and framework with fine flat wood handle.



ITEM	DESCRIPTION	U/M	WEIGHT GROSS lbs	INNER PACK	MASTER PACK	CU. FT.
<b>Fine</b>						
SLSTN5106	6" Single - 6" Diameter x 2 $\frac{1}{2}$ " Height, Handle: 6 $\frac{1}{2}$ "	EACH	19.40	12	48	1.60
SLSTN5108	8" Single - 8" Diameter x 3" Height, Handle: 6 $\frac{1}{2}$ "	EACH	27.25	12	48	2.64
SLSTN5110	10" Single - 10" Diameter x 4 $\frac{1}{8}$ " Height, Handle: 10 $\frac{3}{4}$ "	EACH	25.26	6	24	4.32
SLSTN5206	6" Double - 6" Diameter x 2 $\frac{1}{2}$ " Height, Handle: 6 $\frac{1}{2}$ "	EACH	16.42	12	48	1.60
SLSTN5208	8" Double - 8" Diameter x 3" Height, Handle: 6 $\frac{1}{2}$ "	EACH	29.45	12	48	2.63
SLSTN5210	10" Double - 10" Diameter x 4 $\frac{1}{8}$ " Height, Handle: 10 $\frac{3}{4}$ "	EACH	34.48	6	24	4.32
<b>Medium</b>						
SLSTN5306	6" Single - 6" Diameter x 2 $\frac{1}{2}$ " Height, Handle: 6 $\frac{1}{2}$ "	EACH	17.90	12	48	1.60
SLSTN5308	8" Single - 8" Diameter x 3" Height, Handle: 6 $\frac{1}{2}$ "	EACH	27.25	12	48	2.63
SLSTN5310	10" Single - 10" Diameter x 4 $\frac{1}{8}$ " Height, Handle: 10 $\frac{3}{4}$ "	EACH	25.26	6	24	4.32
SLSTN5406	6" Double - 6" Diameter x 2 $\frac{1}{2}$ " Height, Handle: 6 $\frac{1}{2}$ "	EACH	19.18	12	48	1.60
SLSTN5408	8" Double - 8" Diameter x 3" Height, Handle: 6 $\frac{1}{2}$ "	EACH	29.45	12	48	2.63
SLSTN5410	10" Double - 10" Diameter x 4 $\frac{1}{8}$ " Height, Handle: 10 $\frac{3}{4}$ "	EACH	35.85	6	24	4.32



**STRAINERS (REINFORCED DOUBLE MESH)**

Single mesh wires and framework. An extra cross-support on outer mesh.

ITEM	DESCRIPTION	U/M	WEIGHT GROSS lbs	INNER PACK	MASTER PACK	CU. FT.
<b>Flat Handle</b>						
SLSTN3308R	9 $\frac{1}{2}$ " Double/Fine - 9 $\frac{1}{2}$ " Diameter x 5 $\frac{1}{2}$ " Height, Handle: 13"	EACH	8.82	1	6	2.62
SLSTN3310R	10 $\frac{1}{2}$ " Double/Fine - 10 $\frac{1}{2}$ " Diameter x 6 $\frac{3}{8}$ " Height, Handle: 13"	EACH	13.23	1	6	1.49
<b>Round Handle</b>						
SLSTN3312R	11 $\frac{1}{4}$ " Double/Fine - 11 $\frac{3}{4}$ " Diameter x 6 $\frac{1}{2}$ " Height, Handle: 19 $\frac{1}{4}$ "	EACH	15.43	1	6	2.44
SLSTN3314R	13 $\frac{3}{4}$ " Double/Fine - 13 $\frac{3}{4}$ " Diameter x 8" Height, Handle: 19 $\frac{3}{4}$ "	EACH	17.64	1	6	3.40



With Extra Cross-Support





SLOS001  
SLOS002

**OIL SKIMMER**

Durable stainless steel with perforations all around. Easy to clean surface.



ITEM	DESCRIPTION	U/M	WEIGHT GROSS lbs	INNER PACK	MASTER PACK	CU. FT.
SLOS001	11" Diameter x 3/4" Height, Handle: 5", Hole: 6mm	EACH	27.56	1	24	1.06
SLOS002	12" Diameter x 3/8" Height, Handle: 4 1/2", Hole: 6mm	EACH	29.70	1	24	1.23

**OIL SKIMMER WITH STAINLESS STEEL MESH**

Stainless steel mesh and body frame.



SLSK001  
SLSK002  
SLSK003

ITEM	DESCRIPTION	U/M	WEIGHT GROSS lbs	INNER PACK	MASTER PACK	CU. FT.
SLSK001	9 1/2" Diameter, Handle: 11"	EACH	33.07	12	60	2.30
SLSK002	10 5/8" Diameter, Handle: 11 1/8"	EACH	37.48	12	60	2.30
SLSK003	11 1/4" Diameter, Handle: 11"	EACH	39.68	12	60	2.30

**WIRE SKIMMER**

Prevents spills and unnecessary mess while frying or cooking. Easy to clean surface.

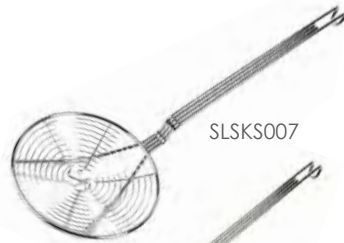

SLSKS007



SLSKS009



SLSKR513



SLSKS514



SLSKR55



SLSKR65M



SLSKR70M



SLSKR60RL

ITEM	DESCRIPTION	U/M	WEIGHT GROSS lbs	INNER PACK	MASTER PACK	CU. FT.
------	-------------	-----	------------------	------------	-------------	---------

**Round Spiral Wire Skimmer, Nickel Plated**

SLSKS007	7" x Diameter, Handle: 13"	EACH	44.09	12	48	1.60
SLSKS009	9" x Diameter, Handle: 13"	EACH	52.91	12	48	2.38

**Round Wire Skimmer, Nickel Plated**

SLSKR513	5" x Diameter, Handle: 12 1/2"	EACH	34.17	12	48	1.03	
SLSKR613	6" x Diameter, Handle: 13"	EACH	36.38	12	48	1.34	Iron Plated
SLSKR713	7" x Diameter, Handle: 12 1/2"	EACH	41.07	12	48	1.60	
SLSKR813	8" x Diameter, Handle: 13"	EACH	42.11	12	48	2.00	
SLSKR913	9" x Diameter, Handle: 13"	EACH	46.30	12	48	2.30	Iron Plated
SLSKR1213	12" x Diameter, Handle: 12 1/2"	EACH	59.52	12	48	4.34	

**Square Wire Skimmer, Nickel Plated**

SLSKS514	5" x 5", Handle: 13 1/2"	EACH	34.17	12	48	1.07	
SLSKS714	7" x 7", Handle: 12 1/2"	EACH	41.01	12	48	1.73	

**Round Fine & Medium Mesh Skimmer, Stainless Steel**

SLSKR55	5 1/2" Diameter, Handle: 9 1/2"	EACH	11.02	12	60	1.852	
SLSKR65	6 1/2" Diameter, Handle: 9 1/2"	EACH	13.88	12	60	2.391	
SLSKR65M	6 1/2" Diameter, Handle: 9 1/2"	EACH	14.11	12	60	2.391	
SLSKR70	7" Diameter, Handle: 10 1/2"	EACH	15.65	12	60	2.728	
SLSKR70M	7" Diameter, Handle: 10 1/2"	EACH	16.09	12	60	2.73	
SLSKR875	8 3/4" Diameter, Handle: 10 7/8"	EACH	31.97	12	72	5.787	



**Reinforced Extra Long Skimmer**

SLSKR60RL	6" Diameter, Handle: 15"	EACH	50.71	12	60	2.75	
SLSKR80RL	8" Diameter, Handle: 18 1/4"	EACH	54.01	12	60	4.04	



**STRAINER WITH BLACK PLASTIC HANDLE**

Strainer with durable, easy to clean sanitary plastic handle.

ITEM	DESCRIPTION	U/M	WEIGHT GROSS	INNER PACK	MASTER PACK	Cu. Ft.
<b>Fine</b>						
SLSTN5106PB	6", Diameter x 2½" Height, Handle: 6½", Hook: 1"	EACH	19.40	12	48	1.60
SLSTN5108PB	8", Diameter x 3" Height, Handle: 6½", Hook: 1"	EACH	27.25	12	48	2.64
SLSTN5110PB	10", Diameter x 4½" Height, Handle: 10¾", Hook: 1¾"	EACH	25.26	6	24	4.32
SLSTN5206PB	6", Diameter x 2½" Height, Handle: 6½", Hook: 1"	EACH	16.42	12	48	1.60
SLSTN5208PB	8", Diameter x 3" Height, Handle: 6½", Hook: 1"	EACH	29.45	12	48	2.63
SLSTN5210PB	10", Diameter x 4½" Height, Handle: 10¾", Hook: 1¾"	EACH	34.48	6	24	4.32
<b>Medium</b>						
SLSTN5306PB	6", Diameter x 2½" Height, Handle: 6½", Hook: 1"	EACH	17.9	12	48	1.6
SLSTN5308PB	8", Diameter x 3" Height, Handle: 6½", Hook: 1"	EACH	27.25	12	48	2.63
SLSTN5310PB	10", Diameter x 4½" Height, Handle: 10¾", Hook: 1¾"	EACH	25.26	6	24	4.32
SLSTN5406PB	6", Diameter x 2½" Height, Handle: 6½", Hook: 1"	EACH	19.18	12	48	1.6
SLSTN5408PB	8", Diameter x 3" Height, Handle: 6½", Hook: 1"	EACH	29.45	12	48	2.63
SLSTN5410PB	10", Diameter x 4½" Height, Handle: 10¾", Hook: 1¾"	EACH	35.85	6	24	4.32

**STAINLESS STEEL STRAINER WITH SUPPORT HANDLE**

Stainless steel single mesh wires and framework handle.



ITEM	DESCRIPTION	U/M	WEIGHT GROSS lbs	INNER PACK	MASTER PACK	Cu. Ft.
SLSTN006	6", Diameter x 2¼" Height, Handle: 5¾", Front Hook: ¾"	EACH	18.08	12	72	0.89
SLSTN008	8", Diameter x 2½" Height, Handle: 6¾", Front Hook: ¾"	EACH	28.55	12	72	1.58
SLSTN009	9", Diameter x 2½" Height, Handle: 8", Front Hook: ¾"	EACH	37.48	12	72	2.07
SLSTN010	10", Diameter x 3½" Height, Handle: 8", Front Hook: ¾"	EACH	45.19	12	72	2.694

**CULINARY BASKET (NICKEL PLATED)**

Heavy nickel-plated wire frame with a securely welded handle. Great for stove top deep-frying.

ITEM	DESCRIPTION	U/M	WEIGHT GROSS	INNER PACK	MASTER PACK	Cu. Ft.
<b>Course</b>						
SLCB008C	8" Diameter x 3" Height, Handle: 9½"	EACH	33.70	1	36	2.00
SLCB010C	10" Diameter x 3" Height, Handle: 9½"	EACH	39.57	1	36	2.40
SLCB012C	12" Diameter x 3" Height, Handle: 9½"	EACH	44.09	1	30	2.80
<b>Fine</b>						
SLCB008F	8" Diameter x 3" Height, Handle: 9½"	EACH	33.07	1	36	2.00
SLCB010F	10" Diameter x 3" Height, Handle: 9½"	EACH	40.12	1	36	2.40
SLCB012F	12" Diameter x 3" Height, Handle: 9½"	EACH	38.58	1	30	2.80

**BREADING BASKET (WHITE PLASTIC COATED)**Wire steel breading baskets with white plastic coating. Made for spreading crumbs.  
**Not intended for frying.**

ITEM	DESCRIPTION	U/M	WEIGHT GROSS lbs	INNER PACK	MASTER PACK	Cu. Ft.
<b>Course</b>						
PLBB008C	8" Round, Coarse, 3" Deep, Handle: 9"	EACH	29.55	1	36	2.51
PLBB010C	10" Round, Coarse, 3" Deep, Handle: 9½"	EACH	37.71	1	36	3.17
PLBB012C	12" Round, Coarse, 3" Deep, Handle: 8"	EACH	44.09	1	36	3.60
<b>Medium</b>						
PLBB008M	8" Round, Medium, 3" Deep, Handle: 9"	EACH	27.50	1	36	2.51
PLBB010M	10" Round, Medium, 3" Deep, Handle: 9½"	EACH	31.90	1	36	3.17
PLBB012M	12" Round, Medium, 3" Deep, Handle: 8"	EACH	37.40	1	36	3.60



\*\* Not intended for frying. \*\*

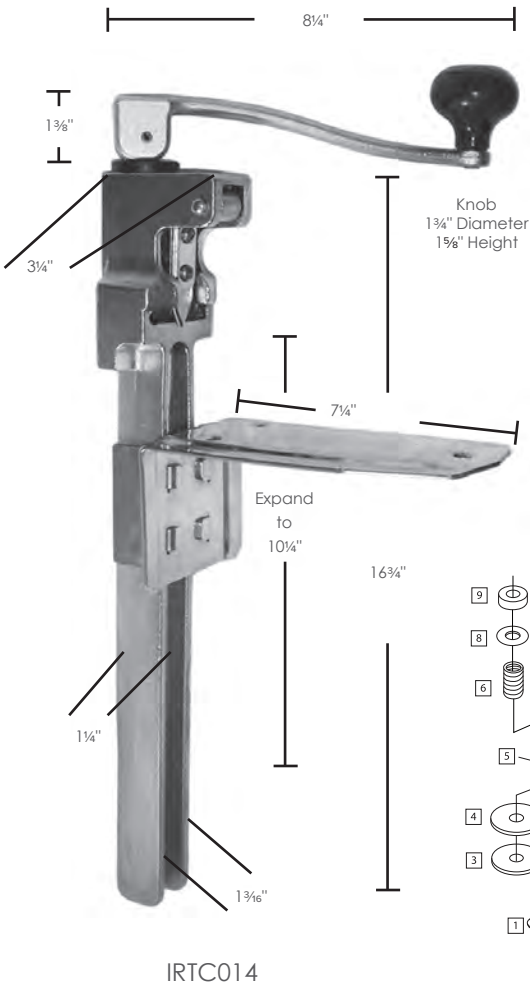

**IMPROVED!**

**TABLE MOUNT CAN OPENER**

14" table mounted can opener, heavy duty. This product is made of heavy duty cast iron. It can open up to 10" tall cans. Designed with easily replaceable blade. Essential for any commercial kitchen that serves canned food. Commercial grade quality, made to endure the toughest condition in any kitchen.

ITEM	DESCRIPTION	U/M	WEIGHT GROSS lbs	INNER PACK	MASTER PACK	CU. FT.
IRTC014	Heavy Duty Table Mounted Can Opener	EACH	55.12	1	6	3.06

**PARTS**

ITEM	DESCRIPTION	U/M
1	IRTC014-01 Screw for Base, Set of 3	SET
2	IRTC014-02 Base	EACH
3	IRTC014-03 Gear	EACH
4	IRTC014-04 Gear Spear	EACH
5	IRTC014-05 Body	EACH
6	IRTC014-06 Spring	EACH
7	IRTC014-07 Arbor	EACH
8	IRTC014-08 Spring Washer	EACH
9	IRTC014-09 Bushing	EACH
10	IRTC014-10 Handle	EACH
11	IRTC014-11 Handle Pin	EACH
12	IRTC014-12 Knob Privet	EACH
13	IRTC014-13 Knob	EACH
14	IRTC014-14 Knife Holder Pin	EACH
15	IRTC014-15 Knife Holder	EACH
16	IRTC014-16 Knife	EACH
17	IRTC014-17 Knife Spear	EACH
18	IRTC014-18 Screw for Knife, Set of 2	SET



**JUICER**

Aluminum juicer with open slot for juicer cup. Perforated filter with funnel can strain most unwanted pulp and extracts fruit juice down to the last drop. They are efficient and stable manual tools. Featuring sure-grip rubber feet to prevent sliding. Also available in cast iron base, with easy to use autolift handle.

Made in Taiwan

ITEM	DESCRIPTION	U/M	WEIGHT GROSS lbs	INNER PACK	MASTER PACK	CU. FT.
ALJM001	13 $\frac{3}{4}$ " Aluminum Juicer with S/S Cup	EACH	23.15	1	6	2.43
IRJM001	Iron Juicer, Cast Iron Base Auto Lift Handle	EACH	33.07	1	2	2.40

**ALJM001**  
5" x 7" x 14 $\frac{1}{2}$ "  
Cup: 4" Diameter x 3 $\frac{1}{4}$ "  
Pulp Strainer: 4 $\frac{1}{4}$ " Diameter x 1" Height  
Top Pusher to be lifted as high as 17"

**IRJM001**  
5 $\frac{3}{4}$ " x 6 $\frac{3}{4}$ " x 23 $\frac{1}{2}$ "  
Cup: 3 $\frac{5}{8}$ " Diameter x 2" Height  
Strainer: 4 $\frac{1}{8}$ " Diameter x 2" Height  
Strainer Cup: 4 $\frac{1}{2}$ " Diameter x 3 $\frac{1}{2}$ " Height



**BRUSH & SCRAPER**

Keep your woks clean with these wood handle Palmyra bristles. Smooth and comfortable design. Wire brushes are built tough and come with a scraper to handle heavy duty jobs.

ITEM	DESCRIPTION	U/M	WEIGHT GROSS lbs	INNER PACK	MASTER PACK	CU. FT.
<b>Wok Brush, Palmyra Bristles</b>						
WDWB008	8" x 3" x 3"	EACH	41.89	12	120	4.94
WDWB012	12" x 3" x 3 $\frac{5}{8}$ "	EACH	35.27	12	60	3.80
WDWB020	20" x 2 $\frac{7}{8}$ " x 3 $\frac{1}{2}$ "	EACH	60.50	12	60	6.32
<b>Wire Brush with Scraper</b>						
WDBS011H	11" x 3" x 2 $\frac{5}{8}$ "	EACH	55.12	12	120	3.24
WDBS014	14" x 2 $\frac{5}{8}$ " x 7 $\frac{3}{4}$ "	EACH	55.12	12	120	2.92
WDBS020H	20" x 3" x 2 $\frac{3}{4}$ "	EACH	46.30	12	72	3.83
WDBS027H	27" x 7" x 3"	SET	28.82	1	24	1.59
<b>Oven Brush with Scraper</b>						
WDPB037	37" x 10" x 4 $\frac{1}{2}$ "	SET	20.92	1	12	1.08

WDWB008 WDWB012 WDWB020



WDBS011H

WDBS014

WDBS020H



WDPB037

WDBS027H

# Stainless Steel Professional Cookware



Heavy-Duty  
Handles

---

Brushed & Polished  
Mirror Finish

Fry Pans  
Sauce Pans  
Double Boilers  
Pasta Cookers  
Stock Pots  
Brazier Pots



Fry Pan  
SLSFP4008 ~ SLSFP4011

Lid Only  
SLDB4008C ~  
SLDB4020C

Fry Pan w/ Helper Handle  
SLSFP4012 ~ SLSFP4014

Double Boiler  
w/ Lid Set  
SLDB4008 ~ SLDB4020

Sauce Pan and Lid  
w/ Helper Handle  
SLSSP4076 ~ SLSSP4100

Sauce Pan w/ Lid  
SLSSP4020 ~ SLSSP4060



Doubly reinforced to outlast all conventional nonsticks.

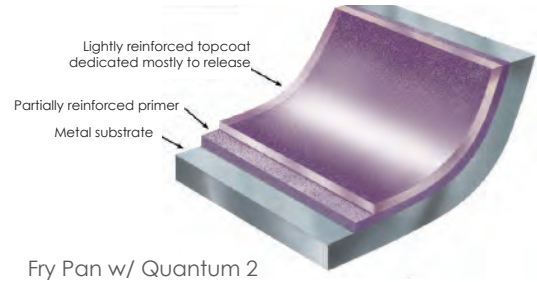

Fry Pan w/ Quantum 2  
SLSFP4108 ~ SLSFP4111

Fry Pan w/ Quantum 2  
w/ Helper Handle  
SLSFP4112 ~ SLSFP4114

**STAINLESS STEEL COOKWARE**

Induction ready. Selected Fry pans come with Quantum 2® Coating.

ITEM	DESCRIPTION	U/M	WEIGHT GROSS lbs	INNER PACK	MASTER PACK	CU. FT.
<b>Fry Pan</b>						
SLSFP4008	8" Diameter x 1 3/4" Height, Handle: 7 5/8"	EACH	9.94	1	6	0.76
SLSFP4009	9 1/2" Diameter x 2 1/4" Height, Handle: 8"	EACH	13.47	1	6	1.23
SLSFP4011	11" Diameter x 2 3/8" Height, Handle: 9 3/8"	EACH	19.29	1	6	1.63
SLSFP4012	12" Diameter x 2 1/2" Height, Handle: 10 1/8", with Helper Handle	EACH	20.28	1	4	1.51
SLSFP4014	14" Diameter x 2 5/8" Height, Handle: 11 1/8", with Helper Handle	EACH	21.91	1	4	2.24
<b>Fry Pan w/ Quantum 2 Coating</b>						
SLSFP4108	8" Diameter x 1 3/4" Height, Handle: 7 5/8"	EACH	9.94	1	6	0.75
SLSFP4109	9 1/2" Diameter x 2 1/4" Height, Handle: 8"	EACH	13.47	1	6	1.23
SLSFP4111	11" Diameter x 2 3/8" Height, Handle: 9 3/8"	EACH	19.29	1	6	1.63
SLSFP4112	12" Diameter x 2 1/2" Height, Handle: 10 1/8", with Helper Handle	EACH	20.28	1	4	1.51
SLSFP4114	14" Diameter x 2 5/8" Height, Handle: 11 1/8", with Helper Handle	EACH	21.91	1	4	2.23
<b>Sauce Pan w/ Lid</b>						
SLSSP4020	2 qt - 7" Diameter x 4" Height, Handle: 7 1/4"	EACH	16.85	1	6	1.88
SLSSP4035	3 1/2 qt - 8 3/8" Diameter x 4 3/8" Height, Handle: 8 7/8"	EACH	24.74	1	6	2.80
SLSSP4045	4 1/2 qt - 8 3/8" Diameter x 5 3/4" Height, Handle: 7 7/8"	EACH	26.19	1	6	3.46
SLSSP4060	6 qt - 10" Diameter x 5 3/8" Height, Handle: 8 3/4"	EACH	32.28	1	6	3.78
SLSSP4076	7 3/8 qt - 10 1/4" Diameter x 6 3/8" Height, Handle: 8 3/4", with Helper Handle: 2 1/4"	EACH	25.57	1	4	3.85
SLSSP4100	10 qt - 11 1/8" Diameter x 6 3/8" Height, Handle: 9 7/8", with Helper Handle: 2 5/8"	EACH	33.49	1	4	5.08
<b>Double Boiler w/ Lid (3 Piece Set)</b>						
SLDB4008	8 qt - 10" Diameter x 7 5/8" Height, Middle: 8 5/8" Diameter x 7 1/4" Height, Handle: 2", Overall Height: 8 3/8"	SET	36.95	1	4	3.70
SLDB4012	12 qt - 10 7/8" Diameter x 7 5/8" Height, Middle: 9 1/2" Diameter x 8 1/2" Height, Handle: 2 3/8", Overall Height: 10"	SET	45.75	1	4	4.89
SLDB4016	16 qt - 11 5/8" Diameter x 10 3/4" Height, Middle: 10 1/4" Diameter x 10" Height, Handle: 2 5/8", Overall Height: 12 1/2"	SET	27.69	1	2	3.13
SLDB4020	20 qt - 12 3/8" Diameter x 11 3/4" Height, Middle: 11" Diameter x 10 7/8" Height, Handle: 2 3/8", Overall Height: 12 3/4"	SET	36.00	1	2	3.59
<b>Double Boiler's Lid Only</b>						
SLDB4008C	Fits SLDB4008 - 10" Diameter x 5/8" Height	EACH	13.69	6	12	1.29
SLDB4012C	Fits SLDB4012 - 11" Diameter x 5/8" Height	EACH	16.96	6	12	1.48
SLDB4016C	Fits SLDB4016 - 11 1/8" Diameter x 5/8" Height	EACH	19.33	6	12	1.68
SLDB4020C	Fits SLDB4020 - 12 1/2" Diameter x 1" Height	EACH	21.43	6	12	1.89

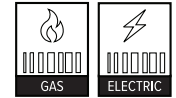
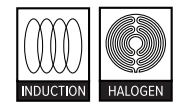

Dishwasher Safe  
Oven Safe 500° F /  
Oven Safe 260° C  
Ceramic Reinforced  
Made without PFOA  
Made without PFOS  
Easy Clean

Lid Only  
SLSPS4008C ~ SLSPS4100C



Pasta Cooker  
w/ Lid  
SLSPC4012  
SLSPC4020



Lid Only  
SLSPC4012C  
SLSPC4020C



Stock Pot w/ Lid  
SLSPS4008 ~ SLSPS4100

Saute Pan w/ Lid  
SLSAP4030 ~ SLSAP4070



Brazier w/ Lid  
SLSBP4015 ~ SLSBP4030

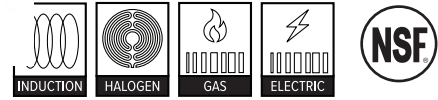

ITEM	DESCRIPTION	U/M	WEIGHT GROSS lbs	INNER PACK	MASTER PACK	CU. FT.
<b>Stock Pot w/ Lid</b>						
SLSPS4008	8 qt - 10" Diameter x 6 $\frac{5}{8}$ " Height, Handle: 2 $\frac{1}{2}$ "	EACH	36.38	1	6	3.96
SLSPS4012	12 qt - 11 $\frac{5}{8}$ " Diameter x 7 $\frac{3}{8}$ " Height, Handle: 2 $\frac{3}{4}$ "	EACH	47.93	1	6	5.58
SLSPS4016	16 qt - 11 $\frac{1}{2}$ " Diameter x 10" Height, Handle: 2 $\frac{5}{8}$ "	EACH	35.76	1	4	4.94
SLSPS4020	20 qt - 12 $\frac{3}{8}$ " Diameter x 10 $\frac{1}{2}$ " Height, Handle: 2 $\frac{1}{2}$ "	EACH	40.04	1	4	5.57
SLSPS4024	24 qt - 14" Diameter x 10 $\frac{3}{8}$ " Height, Handle: 2 $\frac{1}{4}$ "	EACH	55.09	1	4	6.75
SLSPS4032	32 qt - 15" Diameter x 12" Height, Handle: 2 $\frac{3}{8}$ "	EACH	15.98	1	1	2.13
SLSPS4040	40 - 16 $\frac{5}{8}$ " Diameter x 12" Height, Handle: 2 $\frac{3}{8}$ "	EACH	19.67	1	1	2.54
SLSPS4060	60 qt - 18 $\frac{1}{2}$ " Diameter x 14 $\frac{3}{8}$ " Height, Handle: 2 $\frac{3}{8}$ "	EACH	27.57	1	1	3.55
SLSPS4080	80 qt - 20 $\frac{3}{8}$ " Diameter x 16" Height, Handle: 2 $\frac{3}{8}$ "	EACH	34.53	1	1	4.60
SLSPS4100	100 qt - 20 $\frac{1}{2}$ " Diameter x 19 $\frac{5}{8}$ " Height, Handle: 2 $\frac{3}{8}$ "	EACH	40.17	1	1	5.61
<b>Lids</b>						
SLSPS4008C	Fits SLSPS4008, SLSAP4030, SLSPS4060, SLSPS4076 - 10" Diameter x $\frac{1}{2}$ " Thickness	EACH	13.69	6	12	1.29
SLSPS4012C	Fits SLSPS4012 - 11 $\frac{5}{8}$ " Diameter x $\frac{1}{2}$ " Thickness	EACH	19.33	6	12	1.68
SLSPS4016C	Fits SLSPS4016 - 11 $\frac{1}{2}$ " Diameter x $\frac{5}{8}$ " Thickness	EACH	19.33	6	12	1.68
SLSPS4020C	Fits SLSPS4020 & SLSAP4050 - 12 $\frac{3}{8}$ " Diameter x $\frac{5}{8}$ " Thickness	EACH	21.40	6	12	1.89
SLSPS4024C	Fits SLSPS4024 & SLSAP4070 - 14" Diameter x $\frac{5}{8}$ " Thickness	EACH	30.20	6	12	2.51
SLSPS4032C	Fits SLSPS4032 & SLSBP4015 - 15" Diameter x $\frac{1}{2}$ " Thickness	EACH	41.29	6	12	2.78
SLSPS4040C	Fits SLSPS4040 & SLSBP4020 - 16 $\frac{1}{2}$ " Diameter x $\frac{1}{2}$ " Thickness	EACH	25.76	6	12	3.56
SLSPS4060C	Fits SLSPS4060 & SLSBP4025 - 18 $\frac{1}{2}$ " Diameter x $\frac{1}{2}$ " Thickness	EACH	28.41	6	6	2.29
SLSPS4080C	Fits SLSPS4080 & SLSBP4030 - 20 $\frac{3}{8}$ " Diameter x $\frac{5}{8}$ " Thickness	EACH	33.03	6	6	2.78
SLSPS4100C	Fits SLSPS4100 & SLSBP4030 - 20 $\frac{1}{2}$ " Diameter x $\frac{5}{8}$ " Thickness	EACH	33.25	6	6	2.78
<b>Brazier w/ Lid</b>						
SLSBP4015	15 qt - 15" Diameter x 5 $\frac{3}{4}$ " Height, Handle: 2 $\frac{3}{8}$ " (Lid: 15" Diameter x $\frac{1}{2}$ " Thickness)	EACH	12.46	1	1	1.20
SLSBP4020	20 qt - 16 $\frac{1}{2}$ " Diameter x 6 $\frac{1}{4}$ " Height, Handle: 2 $\frac{3}{8}$ " (Lid: 16 $\frac{1}{2}$ " Diameter x $\frac{1}{2}$ " Thickness)	EACH	15.98	1	1	1.50
SLSBP4025	25 qt - 18 $\frac{1}{2}$ " Diameter x 6 $\frac{1}{4}$ " Height, Handle: 2 $\frac{3}{8}$ " (Lid: 18 $\frac{1}{2}$ " Diameter x $\frac{1}{2}$ " Thickness)	EACH	20.94	1	1	1.75
SLSBP4030	30 qt - 20 $\frac{3}{8}$ " Diameter x 6 $\frac{3}{8}$ " Height, Handle: 2 $\frac{1}{4}$ " (Lid: 20 $\frac{3}{8}$ " Diameter x $\frac{5}{8}$ " Thickness)	EACH	21.89	1	1	2.07
<b>Saute Pan w/ Lid</b>						
SLSAP4030	3 qt Helper Handle - 10" Diameter x 2 $\frac{7}{8}$ " Height, Handle: 8 $\frac{1}{2}$ ", Helper Handle: 2"	EACH	39.88	1	8	3.88
SLSAP4050	5 qt Helper Handle - 12 $\frac{3}{8}$ " Diameter x 3" Height, Handle: 10 $\frac{5}{8}$ ", Helper Handle: 2 $\frac{1}{8}$ "	EACH	49.87	1	6	4.65
SLSAP4070	7 qt Helper Handle - 14" Diameter x 3 $\frac{3}{8}$ " Height, Handle: 11 $\frac{3}{8}$ ", Helper Handle: 1 $\frac{3}{4}$ "	EACH	29.23	1	6	6.08

**Pasta Cooker w/ Lid - 3 Piece Set**

SLSPC4012	12 qt - 10 <sup>7</sup> / <sub>8</sub> " Diameter x 9 <sup>3</sup> / <sub>8</sub> " Height, Basket: 9 <sup>5</sup> / <sub>8</sub> " Diameter x 8 <sup>1</sup> / <sub>2</sub> " Height, Handle: 2 <sup>5</sup> / <sub>8</sub> ", Overall Height 11 <sup>1</sup> / <sub>4</sub> "	EACH	45.75	1	4	4.89
SLSPC4020	20 qt - 12 <sup>3</sup> / <sub>8</sub> " Diameter x 11 <sup>5</sup> / <sub>8</sub> " Height, Basket: 11 <sup>1</sup> / <sub>4</sub> " Diameter x 10 <sup>3</sup> / <sub>4</sub> " Height, Handle: 2 <sup>3</sup> / <sub>8</sub> ", Overall Height 12 <sup>3</sup> / <sub>8</sub> "	EACH	36.00	1	2	3.59

**Pasta Cooker Lids**

SLSPC4012C	Fits SLSPC4012 - 11" Diameter x 1/2" Thickness	EACH	19.31	6	12	1.68
SLSPC4020C	Fits SLSPC4020 - 12 <sup>1</sup> / <sub>2</sub> " Diameter x 3/4" Thickness	EACH	21.43	6	12	1.89

**7-PIECE STAINLESS STEEL COOKWARE SET**

Tri-ply premium stainless steel cookware, with conductive aluminum core that evenly distributes heat sandwiched between 18/0 stainless steel exterior & 18/8 stainless steel interior. This allows the walls of the cookware to be as hot as the bottom.

The cookware features shaped handles that stay cool to the touch.

The 7-piece set includes 1 1/2 qt sauce pan with lid, 2 qt sauce pan with lid, 6 qt stockpot with lid, and a 2 1/2 qt open fry pan.



Handles that stay cool to the touch.



TRI-PLY

- 18/8 Stainless Steel
- Aluminum Core
- 18/0 Stainless Steel



SLCK007

ITEM	DESCRIPTION	U/M	WEIGHT GROSS lbs	INNER PACK	MASTER PACK	CU. FT.
SLCK007	<b>Tri-Ply Cookware, 7 piece set</b>	SET	29.73	1	2	2.31
	<b>1 1/2 qt Sauce Pan w/ lid</b> Pan: 6 <sup>7</sup> / <sub>8</sub> " Diameter x 3 <sup>1</sup> / <sub>2</sub> " Deep, Handle: 6", Lid: 7" Diameter x 3/8" Thickness, 1 <sup>3</sup> / <sub>4</sub> " Handles					
	<b>2 qt Sauce Pan w/ lid</b> Pan: 7 <sup>5</sup> / <sub>8</sub> " Diameter x 3 <sup>1</sup> / <sub>2</sub> " Deep, Handle: 6 <sup>7</sup> / <sub>8</sub> ", Lid: 7 <sup>3</sup> / <sub>4</sub> " Diameter x 3/8" Thickness, 1 <sup>3</sup> / <sub>4</sub> " Handles					
	<b>6 qt Stockpot w/ lid</b> Pot: 10 <sup>1</sup> / <sub>8</sub> " Diameter x 5 <sup>1</sup> / <sub>8</sub> " Height, Handle: 2", Lid: 10 <sup>1</sup> / <sub>4</sub> " Diameter x 1/2" Thickness, 2 <sup>1</sup> / <sub>4</sub> " Handles					
	<b>2 1/2 qt Saute Pan w/o lid</b> Pan: 10 <sup>1</sup> / <sub>8</sub> " Diameter x 2 <sup>3</sup> / <sub>8</sub> " Deep, Handle: 6 <sup>7</sup> / <sub>8</sub> ", 1 <sup>3</sup> / <sub>4</sub> " Handles					

Aluminum Stock Pot  
ALSKSP001 ~ ALSKSP011

Aluminum Stock Pot Lid  
ALSKSP101 ~ ALSKSP115



w/ QUAD HANDLES  
ALSKSP012  
ALSKSP013  
ALSKSP014  
ALSKSP015



**ALUMINUM STOCK POT & LID**

Stock pot with commercial thickness for efficient heating. Dent resistant surface to endure the toughest conditions in a professional kitchen. Easy to clean.

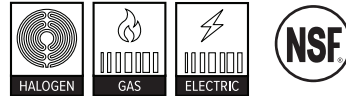

ITEM	DESCRIPTION	U/M	WEIGHT GROSS lbs	INNER PACK	MASTER PACK	CU. FT.
<b>Stock Pots - Regular</b>						
ALSKSP001	8 qt - 10" Diameter x 7 <sup>3</sup> / <sub>8</sub> " Height, Handle: 1 <sup>3</sup> / <sub>8</sub> ", 4mm Thickness	EACH	3.75	1	1	0.66
ALSKSP002	12 qt - 10 <sup>1</sup> / <sub>4</sub> " Diameter x 9 <sup>1</sup> / <sub>4</sub> " Height, Handle: 1 <sup>2</sup> / <sub>3</sub> ", 4mm Thickness	EACH	4.50	1	1	0.88
ALSKSP003	16 qt - 10 <sup>1</sup> / <sub>4</sub> " Diameter x 7 <sup>3</sup> / <sub>8</sub> " Height, Handle: 1 <sup>1</sup> / <sub>2</sub> ", 4mm Thickness	EACH	5.75	1	1	1.13
ALSKSP004	20 qt - 12 <sup>1</sup> / <sub>4</sub> " Diameter x 11" Height, Handle: 1 <sup>5</sup> / <sub>8</sub> ", 4mm Thickness	EACH	7.05	1	1	1.39
ALSKSP005	24 qt - 13" Diameter x 11 <sup>3</sup> / <sub>8</sub> " Height, Handle: 1 <sup>2</sup> / <sub>3</sub> ", 4mm Thickness	EACH	4.89	1	1	1.44
ALSKSP006	32 qt - 14 <sup>1</sup> / <sub>4</sub> " Diameter x 13" Height, Handle: 1 <sup>3</sup> / <sub>8</sub> ", 4mm Thickness	EACH	6.24	1	1	1.93
ALSKSP007	40 qt - 14 <sup>3</sup> / <sub>8</sub> " Diameter x 14 <sup>1</sup> / <sub>2</sub> " Height, Handle: 1 <sup>5</sup> / <sub>8</sub> ", 4mm Thickness	EACH	8.82	1	1	1.93
ALSKSP008	50 qt - 16 <sup>3</sup> / <sub>8</sub> " Diameter x 14 <sup>7</sup> / <sub>8</sub> " Height, Handle: 2", 4mm Thickness	EACH	10.50	1	1	2.80
ALSKSP009	60 qt - 16 <sup>3</sup> / <sub>8</sub> " Diameter x 17 <sup>3</sup> / <sub>8</sub> " Height, Handle: 2", 4mm Thickness	EACH	12.79	1	1	3.21
ALSKSP010	80 qt - 19 <sup>1</sup> / <sub>4</sub> " Diameter x 17" Height, Handle: 2 <sup>1</sup> / <sub>8</sub> ", 4mm Thickness	EACH	15.87	1	1	4.11
ALSKSP011	100 qt - 20 <sup>1</sup> / <sub>4</sub> " Diameter x 28 <sup>3</sup> / <sub>8</sub> " Height, Handle: 2", 4mm Thickness	EACH	17.42	1	1	4.83
<b>w/ Quad Handles</b>						
ALSKSP012	120 qt - 22" Diameter x 19 <sup>3</sup> / <sub>8</sub> " Height, Handle: 2 <sup>5</sup> / <sub>8</sub> ", 6mm Thickness	EACH	20.94	1	1	6.24
ALSKSP013	140 qt - 23" Diameter x 19 <sup>3</sup> / <sub>4</sub> " Height, Handle: 2 <sup>1</sup> / <sub>2</sub> ", 6mm Thickness	EACH	22.75	1	1	6.96
ALSKSP014	160 qt - 24 <sup>1</sup> / <sub>4</sub> " Diameter x 21 <sup>3</sup> / <sub>4</sub> " Height, Handle: 1 <sup>5</sup> / <sub>8</sub> ", 6mm Thickness	EACH	25.58	1	1	7.93
ALSKSP015	200 qt - 24 <sup>3</sup> / <sub>8</sub> " Diameter x 27 <sup>3</sup> / <sub>8</sub> " Height, Handle: 1 <sup>5</sup> / <sub>8</sub> ", 6mm Thickness	EACH	27.56	1	1	9.75
<b>Lids</b>						
<b>1.5 mm Thickness</b>						
ALSKSP101	Fits ALSKSP001 & ALSKSP601, 9 <sup>3</sup> / <sub>4</sub> " Diameter x 1 <sup>1</sup> / <sub>4</sub> " Height	EACH	7.94	1	6	0.32
ALSKSP102	Fits ALSKSP002 & ALSKSP602, 10 <sup>5</sup> / <sub>8</sub> " Diameter x 1 <sup>1</sup> / <sub>4</sub> " Height	EACH	8.38	1	6	0.38
ALSKSP103	Fits ALSKSP003 & ALSKSP603, 11 <sup>1</sup> / <sub>8</sub> " Diameter x 1 <sup>1</sup> / <sub>4</sub> " Height	EACH	7.50	1	6	0.49
ALSKSP104	Fits ALSKSP004 & ALSKSP604, 13" Diameter x 1 <sup>1</sup> / <sub>4</sub> " Height	EACH	8.00	1	6	0.54
ALSKSP105	Fits ALSKSP005 & ALSKSP605, 13 <sup>1</sup> / <sub>2</sub> " Diameter x 1 <sup>1</sup> / <sub>4</sub> " Height	EACH	9.04	1	6	0.62
ALSKSP106	Fits ALSKSP006 & ALSKSP606, 13 <sup>3</sup> / <sub>8</sub> " Diameter x 1 <sup>1</sup> / <sub>4</sub> " Height	EACH	9.46	1	6	0.71
ALSKSP107	Fits ALSKSP007 & ALSKSP607, 15 <sup>3</sup> / <sub>8</sub> " Diameter x 1 <sup>1</sup> / <sub>4</sub> " Height	EACH	9.68	1	6	0.72
<b>1.8 mm Thickness</b>						
ALSKSP108	Fits ALSKSP008 & ALSKSP608, 16 <sup>3</sup> / <sub>4</sub> " Diameter x 1 <sup>1</sup> / <sub>4</sub> " Height	EACH	11.24	1	6	0.88
ALSKSP109	Fits ALSKSP009 & ALSKSP609, 16 <sup>3</sup> / <sub>4</sub> " Diameter x 1 <sup>1</sup> / <sub>4</sub> " Height	EACH	11.22	1	6	0.88
ALSKSP110	Fits ALSKSP010 & ALSKSP610, 19 <sup>3</sup> / <sub>4</sub> " Diameter x 1 <sup>1</sup> / <sub>4</sub> " Height	EACH	12.57	1	6	1.19
ALSKSP111	Fits ALSKSP011 & ALSKSP611, 20 <sup>3</sup> / <sub>8</sub> " Diameter x 1 <sup>1</sup> / <sub>4</sub> " Height	EACH	11.89	1	6	1.33
ALSKSP112	Fits ALSKSP012, 22 <sup>3</sup> / <sub>4</sub> " Diameter x 1 <sup>1</sup> / <sub>4</sub> " Height	EACH	13.45	1	6	1.47
ALSKSP113	Fits ALSKSP013, 22 <sup>3</sup> / <sub>4</sub> " Diameter x 1 <sup>1</sup> / <sub>4</sub> " Height	EACH	13.90	1	6	1.74
ALSKSP114	Fits ALSKSP014, 24 <sup>3</sup> / <sub>8</sub> " Diameter x 1 <sup>1</sup> / <sub>4</sub> " Height	EACH	13.90	1	6	1.74
ALSKSP115	Fits ALSKSP015, 24 <sup>3</sup> / <sub>4</sub> " Diameter x 1 <sup>1</sup> / <sub>4</sub> " Height	EACH	13.90	1	6	1.88





**Heavy Duty Aluminum Stock Pot**  
6 mm Wall Thickness

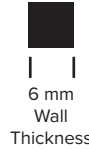

**HEAVY DUTY ALUMINUM STOCK POT**

Constructed with industrial strength riveted loop handles. These heavy duty stock pots provide excellent heat distribution. Dent resistant surface with wall thickness of 6 mm can endure the toughest conditions in a professional kitchen. Capacity ranges from 8 qt to 100 qt.

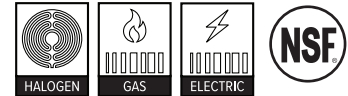

ITEM	DESCRIPTION	U/M	WEIGHT GROSS lbs	INNER PACK	MASTER PACK	CU. FT.
ALSKSP601	8 qt - 9 <sup>5</sup> / <sub>8</sub> " Diameter x 7 <sup>1</sup> / <sub>2</sub> " Height, Handle: 1 <sup>3</sup> / <sub>8</sub> "	EACH	6.36	1	1	0.57
ALSKSP602	12 qt - 10 <sup>1</sup> / <sub>2</sub> " Diameter x 9 <sup>1</sup> / <sub>2</sub> " Height, Handle: 1 <sup>3</sup> / <sub>8</sub> "	EACH	7.47	1	1	0.81
ALSKSP603	16 qt - 11 <sup>1</sup> / <sub>2</sub> " Diameter x 10 <sup>1</sup> / <sub>4</sub> " Height, Handle: 1 <sup>3</sup> / <sub>8</sub> "	EACH	8.46	1	1	1.01
ALSKSP604	20 qt - 12 <sup>3</sup> / <sub>8</sub> " Diameter x 11 <sup>1</sup> / <sub>4</sub> " Height, Handle: 1 <sup>3</sup> / <sub>8</sub> "	EACH	9.82	1	1	1.15
ALSKSP605	24 qt - 13" Diameter x 11 <sup>1</sup> / <sub>2</sub> " Height, Handle: 1 <sup>1</sup> / <sub>2</sub> "	EACH	10.18	1	1	1.32
ALSKSP606	32 qt - 14 <sup>3</sup> / <sub>8</sub> " Diameter x 13" Height, Handle: 1 <sup>3</sup> / <sub>8</sub> "	EACH	11.53	1	1	1.76
ALSKSP607	40 qt - 15" Diameter x 14 <sup>1</sup> / <sub>2</sub> " Height, Handle: 1 <sup>1</sup> / <sub>2</sub> "	EACH	12.59	1	1	2.12
ALSKSP608	50 qt - 16 <sup>3</sup> / <sub>8</sub> " Diameter x 15" Height, Handle: 2"	EACH	14.68	1	1	2.61
ALSKSP609	60 qt - 16 <sup>3</sup> / <sub>8</sub> " Diameter x 17 <sup>1</sup> / <sub>3</sub> " Height, Handle: 1 <sup>3</sup> / <sub>3</sub> "	EACH	16.17	1	1	3.00
ALSKSP610	80 qt - 19 <sup>1</sup> / <sub>4</sub> " Diameter x 17" Height, Handle: 1 <sup>3</sup> / <sub>4</sub> "	EACH	18.56	1	1	3.97
ALSKSP611	100 qt - 20 <sup>3</sup> / <sub>8</sub> " Diameter x 18 <sup>1</sup> / <sub>2</sub> " Height, Handle: 2"	EACH	20.48	1	1	5.00

**ALUMINUM STEAMER BASKET FOR STOCK POT**

Aluminum cylindrical steamer basket with perforated holes for steaming vegetables, seafood, or deep frying large poultry. Fits inside stock pots of 16 qt to 100 qt. Easy lift pail handle and smooth mirror finish that's easy to wash and maintain.

ITEM	DESCRIPTION	U/M	WEIGHT GROSS lbs	INNER PACK	MASTER PACK	CU. FT.
ALSKBK002	Fits 16 qt ALSKSP003, 9 <sup>3</sup> / <sub>4</sub> " Diameter x 8 <sup>3</sup> / <sub>8</sub> " Height, Rolled Edge: <sup>1</sup> / <sub>4</sub> ", Handle: 5", Bottom: 9 <sup>1</sup> / <sub>4</sub> " Diameter	EACH	1.90	1	1	0.55
ALSKBK003	Fits 20 qt ALSKSP004, 10 <sup>1</sup> / <sub>2</sub> " Diameter x 8 <sup>3</sup> / <sub>4</sub> " Height, Rolled Edge: <sup>1</sup> / <sub>4</sub> ", Handle: 5 <sup>3</sup> / <sub>4</sub> ", Bottom: 9 <sup>1</sup> / <sub>4</sub> " Diameter	EACH	2.36	1	1	0.51
ALSKBK005	Fits 24 qt ALSKSP005, 11 <sup>3</sup> / <sub>8</sub> " Diameter x 9 <sup>1</sup> / <sub>2</sub> " Height, Rolled Edge: <sup>3</sup> / <sub>8</sub> ", Handle: 6 <sup>1</sup> / <sub>4</sub> ", Bottom: 10 <sup>7</sup> / <sub>8</sub> " Diameter	EACH	2.59	1	1	1.05
ALSKBK006	Fits 32 qt ALSKSP006, 12 <sup>1</sup> / <sub>4</sub> " Diameter x 10 <sup>1</sup> / <sub>2</sub> " Height, Rolled Edge: <sup>3</sup> / <sub>8</sub> ", Handle: 6 <sup>5</sup> / <sub>8</sub> ", Bottom: 11 <sup>3</sup> / <sub>4</sub> " Diameter	EACH	3.00	1	1	0.79
ALSKBK007	Fits 40 qt ALSKSP007, 13 <sup>3</sup> / <sub>8</sub> " Diameter x 11" Height, Rolled Edge: <sup>3</sup> / <sub>8</sub> ", Handle: 6 <sup>7</sup> / <sub>8</sub> ", Bottom: 12 <sup>3</sup> / <sub>4</sub> " Diameter	EACH	3.91	1	1	1.34
ALSKBK008	Fits 50 qt ALSKSP008 & 60 qt ALSKSP009, 14 <sup>1</sup> / <sub>2</sub> " Diameter x 12 <sup>5</sup> / <sub>8</sub> " Height, Rolled Edge: <sup>3</sup> / <sub>8</sub> ", Handle: 7 <sup>3</sup> / <sub>4</sub> ", Bottom: 13 <sup>5</sup> / <sub>8</sub> " Diameter	EACH	5.00	1	1	1.62
ALSKBK010	Fits 80 qt ALSKSP010, 16 <sup>3</sup> / <sub>8</sub> " Diameter x 14" Height, Rolled Edge: <sup>3</sup> / <sub>8</sub> ", Handle: 8 <sup>3</sup> / <sub>4</sub> ", Bottom: 15 <sup>1</sup> / <sub>2</sub> " Diameter	EACH	5.86	1	1	2.09
ALSKBK012	Fits 100 qt ALSKSP011, 18 <sup>1</sup> / <sub>4</sub> " Diameter x 15 <sup>3</sup> / <sub>8</sub> " Height, Rolled Edge: <sup>3</sup> / <sub>8</sub> ", Handle: 9", Bottom: 17 <sup>1</sup> / <sub>4</sub> " Diameter	EACH	6.88	1	1	2.55

Steamer Basket  
ALSKBK002 ~ ALSKBK012



### ALUMINUM SAUTE PAN & LID

Snug lid is an exact fit to prevent spills while cooking. Flat bottom assures even cooking with rounded edges for smooth stirring.

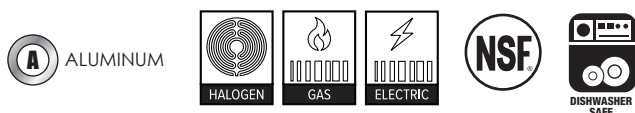

ITEM	DESCRIPTION	U/M	WEIGHT GROSS lbs	INNER PACK	MASTER PACK	CU. FT.
<b>Saute Pan - 3.5 mm</b>						
ALSAP001	2 qt - 8 $\frac{3}{8}$ " Diameter x 3 $\frac{1}{2}$ " Height, Handle: 6 $\frac{5}{8}$ "	EACH	11.86	1	6	0.96
ALSAP002	3 qt - 10 $\frac{3}{8}$ " Diameter x 3 $\frac{1}{2}$ " Height, Handle: 8"	EACH	17.00	1	6	2.14
ALSAP003	5 qt - 12" Diameter x 5 $\frac{1}{2}$ " Height, Handle: 9 $\frac{3}{4}$ "	EACH	21.83	1	6	3.34
ALSAP004	7 qt - 14 $\frac{1}{4}$ " Diameter x 4 $\frac{5}{8}$ " Height, Handle: 12 $\frac{1}{4}$ "	EACH	34.00	1	6	2.92
<b>Cover</b>						
ALSAP101	Fits ALSAP001, 7 $\frac{1}{2}$ " Diameter x 1 $\frac{1}{4}$ " Height	EACH	3.17	1	6	0.28
ALSAP102	Fits ALSAP002, 9 $\frac{1}{2}$ " Diameter x 1 $\frac{1}{4}$ " Height	EACH	5.50	1	6	0.37
ALSAP103	Fits ALSAP003, 11 $\frac{1}{2}$ " Diameter x 1 $\frac{1}{4}$ " Height	EACH	7.94	1	6	0.49
ALSAP104	Fits ALSAP004, 13 $\frac{3}{8}$ " Diameter x 1 $\frac{1}{4}$ " Height	EACH	11.03	1	6	0.92

### ALUMINUM SAUCE POT & LID

Dent resistant surface to endure professional kitchen duties. Lid prevents contamination from unwanted food residue. Easy to clean.

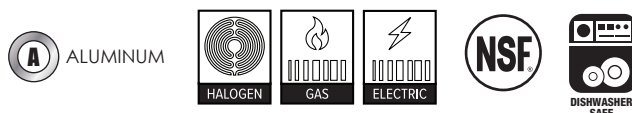

ITEM	DESCRIPTION	U/M	WEIGHT GROSS lbs	INNER PACK	MASTER PACK	CU. FT.
<b>Sauce Pot</b>						
ALSKSU005	5 qt - 8 $\frac{1}{2}$ " Diameter x 5 $\frac{1}{4}$ " Height, Handle: 1 $\frac{3}{8}$ "	EACH	5.06	1	1	0.35
ALSKSU008	8 qt - 10 $\frac{3}{8}$ " Diameter x 6 $\frac{3}{8}$ " Height, Handle: 1 $\frac{3}{8}$ "	EACH	5.28	1	1	0.59
ALSKSU014	14 qt - 12 $\frac{1}{4}$ " Diameter x 7 $\frac{1}{2}$ " Height, Handle: 1 $\frac{3}{4}$ "	EACH	9.46	1	1	0.94
ALSKSU020	20 qt - 13 $\frac{3}{4}$ " Diameter x 8 $\frac{5}{8}$ " Height, Handle: 1 $\frac{3}{4}$ "	EACH	9.92	1	1	1.25
ALSKSU026	26 qt - 14 $\frac{1}{4}$ " Diameter x 10" Height, Handle: 1 $\frac{3}{4}$ "	EACH	10.58	1	1	1.41
ALSKSU036	36 qt - 16 $\frac{1}{8}$ " Diameter x 9 $\frac{7}{8}$ " Height, Handle: 2"	EACH	12.57	1	1	1.87
ALSKSU040	40 qt - 18 $\frac{1}{4}$ " Diameter x 10 $\frac{5}{8}$ " Height, Handle: 2"	EACH	14.00	1	1	2.22
ALSKSU060	60 qt - 20 $\frac{1}{4}$ " Diameter x 11 $\frac{1}{8}$ " Height, Handle: 2 $\frac{1}{8}$ "	EACH	15.84	1	1	3.04
<b>Lid</b>						
ALSKSU105	Fits ALSKSU005, 9" Diameter x $\frac{5}{8}$ " Height	EACH	2.81	1	6	0.24
ALSKSU108	Fits ALSKSU008, 11" Diameter x $\frac{5}{8}$ " Height	EACH	4.07	1	6	0.41
ALSKSU114	Fits ALSKSU014, 12 $\frac{5}{8}$ " Diameter x $\frac{5}{8}$ " Height	EACH	5.38	1	6	0.55
ALSKSU120	Fits ALSKSU020, 13 $\frac{3}{4}$ " Diameter x $\frac{5}{8}$ " Height	EACH	7.17	1	6	0.58
ALSKSU126	Fits ALSKSU026, 14 $\frac{5}{8}$ " Diameter x $\frac{5}{8}$ " Height	EACH	7.40	1	6	0.64
ALSKSU136	Fits ALSKSU036, 16 $\frac{3}{4}$ " Diameter x $\frac{5}{8}$ " Height	EACH	11.26	1	6	0.83
ALSKSU140	Fits ALSKSU040, 18 $\frac{3}{4}$ " Diameter x $\frac{5}{8}$ " Height	EACH	13.99	1	6	1.07
ALSKSU160	Fits ALSKSU060, 20 $\frac{3}{4}$ " Diameter x $\frac{5}{8}$ " Height	EACH	17.03	1	6	1.48

## ALUMINUM BRAZIER POT WITH LID (EXTRA HEAVY)

Extra-heavy 6 mm thick aluminum brazier pots with lids. Mirror-finished surface allows easy maintenance. Flat bottom for even level cooking. Capacity ranges from 8 qt to 40 qt.



Made in Korea



Brazier Pot w/ Lid  
ALSKBP001 ~ ALSKBP008

ITEM	DESCRIPTION	U/M	WEIGHT GROSS lbs	INNER PACK	MASTER PACK	CU. FT.
ALSKBP001	8 qt - 11½" Diameter x 5½" Height, Handle: 1¾", Lid: 11¾" Diameter x ¾", Handle: 1"	EACH	6.60	1	1	0.67
ALSKBP002	12 qt - 13¼" Diameter x 5½" Height, Handle: 1¾", Lid: 13¾" Diameter x ¾", Handle: 1"	EACH	9.68	1	1	0.85
ALSKBP003	14 qt - 14¼" Diameter x 5½" Height, Handle: 1¾", Lid: 14¾" Diameter x ¾", Handle: 1"	EACH	9.75	1	1	0.97
ALSKBP004	20 qt - 16¾" Diameter x 5½" Height, Handle: 2½", Lid: 16¾" Diameter x ¾", Handle: 1"	EACH	10.12	1	1	1.25
ALSKBP005	24 qt - 18¼" Diameter x 5½" Height, Handle: 2½", Lid: 18½" Diameter x ¾", Handle: 1"	EACH	9.90	1	1	1.45
ALSKBP006	30 qt - 20¼" Diameter x 5½" Height, Handle: 2½", Lid: 20¾" Diameter x ¾", Handle: 1"	EACH	12.13	1	1	1.58
ALSKBP007	35 qt - 21¾" Diameter x 5¾" Height, Handle: 2½", Lid: 22½" Diameter x ¾", Handle: 1"	EACH	12.79	1	1	1.97
ALSKBP008	40 qt - 23¼" Diameter x 5¾" Height, Handle: 2½", Lid: 23¾" Diameter x ¾", Handle: 1"	EACH	18.48	1	1	2.47

## ALUMINUM PASTA COOKER SET

Facilitates cooking pasta to the right texture and consistency. Capacity from 12 qt to 20 qt. ALSKPC005 (5 piece set) features four sectioned perforated strainers to allow quick and multiple pasta cooking without constantly replacing the water. Easy to clean.



ITEM	DESCRIPTION	U/M	WEIGHT GROSS lbs	INNER PACK	MASTER PACK	CU. FT.
ALSKPC005	20 qt, 5 PC Set - 14½" Diameter x 7½" Height, Handle: 1¾"	SET	12.00	1	1	1.93
ALSKPC112	12 qt, 3 PC Set - 10½" Diameter x 9½" Height, Handle: 1¾", Middle: 9¼" Diameter x 9½" Height, Lid: 11¼" Diameter x ¾" Height, Handle: 1"	SET	7.75	1	1	1.13
ALSKPC120	20 qt, 3 PC Set - Outer Pot: 11¾" Diameter x 9¾" Height, Handle: 1¾". Middle Pot: 11¼" Diameter x 9¾" Height. Lid 13¼" x ¾", Lid Handle: 1"	SET	10.00	1	1	1.58

Pasta Cooker ALSKPC005

w/ Stainless Steel Sectioned Perforated Strainers



Pasta Cooker

ALSKPC112  
ALSKPC120



ALRP9604



ALRP9603



## ALUMINUM DOUBLE ROASTER

Aluminum roasters with straps and lugs for **secure and spill-proof roast**. Pan without bottom is also available. Two durable handles on the front and back to allow level transport. Made with rounded corners and smooth surface for easy cleaning. **2.2 mm/12 gauge**. -40° F ~ 600° F



ITEM	DESCRIPTION	U/M	WEIGHT GROSS lbs	INNER PACK	MASTER PACK	CU. FT.
ALRP9603	18" x 24" x 4½" w/ Strap	EACH	37.69	1	4	3.45
ALRP9604	18" x 24" x 4½" w/ Strap & Lug	EACH	37.69	1	4	3.52
ALRP9605	18" x 24" x 4½"	EACH	36.25	1	4	3.95

ALRP9605

## ALUMINUM SAUCE PAN & LID

Durable and dent resistant. Flat bottom for even heat distribution.

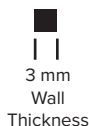

Sauce Pan  
ALKSS001 ~ ALKSS007



Sauce Pan  
ALKSS008



Lid Only  
ALSKSS101 ~ ALSKSS108

ITEM	DESCRIPTION	U/M	WEIGHT GROSS lbs	INNER PACK	MASTER PACK	CU. FT.
<b>Sauce Pans</b>						
ALKSS001	2.6mm - 1½ qt - 6¼" Diameter x 3¾" Height, Handle: 6¼"	EACH	10.58	1	6	0.67
ALKSS002	2.6mm - 2¼ qt - 8¼" Diameter x 4" Height, Handle: 6¼"	EACH	12.57	1	6	0.89
ALKSS003	2.6mm - 3¼ qt - 9" Diameter x 4¾" Height, Handle: 7½"	EACH	13.66	1	6	1.09
ALKSS004	2.6mm - 4½ qt - 9¾" Diameter x 5" Height, Handle: 7½"	EACH	14.77	1	6	1.15
ALKSS005	2.6mm - 5½ qt - 10¼" Diameter x 5½" Height, Handle: 7½"	EACH	16.53	1	6	1.67
ALKSS006	2.6mm - 7 qt - 10¾" Diameter x 5¾" Height, Handle: 9¾"	EACH	17.20	1	6	1.97
ALKSS007	2.6mm - 8½ qt - 11½" Diameter x 5½" Height, Handle: 10"	EACH	19.84	1	6	2.85
ALKSS008	2.6mm - 10 qt - 12¾" Diameter x 5¾" Height, Handle: 10"	EACH	22.05	1	6	3.25
<b>Lids</b>						
ALSKSS101	1mm - 1½ qt - 6¾" Diameter x ¾" Thickness, Handle: 1"	EACH	5.06	1	6	0.22
ALSKSS102	1mm - 2¼ qt - 8½" Diameter x ¾" Thickness, Handle: 1"	EACH	5.95	1	6	0.38
ALSKSS103	1mm - 3¼ qt - 9¼" Diameter x ¾" Thickness, Handle: 1"	EACH	6.38	1	6	0.48
ALSKSS104	1mm - 4½ qt - 10" Diameter x ¾" Thickness, Handle: 1"	EACH	7.04	1	6	0.55
ALSKSS105	1.1mm - 5½ qt - 10¾" Diameter x ¾" Thickness, Handle: 1"	EACH	7.48	1	6	0.66
ALSKSS106	1.1mm - 7 qt - 11½" Diameter x ¾" Thickness, Handle: 1"	EACH	8.58	1	6	0.71
ALSKSS107	1.1mm - 8½ qt - 12¼" Diameter x ¾" Thickness, Handle: 1½"	EACH	9.02	1	6	0.83
ALSKSS108	1.1mm - 10 qt - 13" Diameter x ¾" Thickness, Handle: 1½"	EACH	9.90	1	6	0.95

## ALUMINUM FRYER SAUCE PAN

Mirror finish. Extended stem catcher bolted on to hold fry baskets.  
Note: ALSF001 and ALSF002 compatible with SLFB002. ALSF003 fits SLFB001

Fryer Sauce Pan  
ALSF001 ~ ALSF003

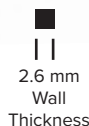

ITEM	DESCRIPTION	U/M	WEIGHT GROSS lbs	INNER PACK	MASTER PACK	CU. FT.
ALSF001	Compatible with SLFB002 5.5 qt - 10½" Diameter x 5¾" Height, 7¾" Handle, 3¾" Stem	EACH	22.50	1	10	2.97
ALSF002	Compatible with SLFB002 7 qt - 10½" Diameter x 5¾" Height, 9¾" Handle, 3¾" Stem	EACH	24.50	1	8	3.14
ALSF003	Compatible with SLFB001 10 qt - 11¾" Diameter x 6½" Height, 9¾" Handle, 4" Stem	EACH	23.00	1	6	3.76

**ALUMINUM DOUBLE BOILER**

The heavy-gauge mirror-finished surface withstands heavy use in the kitchen. Top fits snug to properly cook delicate sauces or soups.

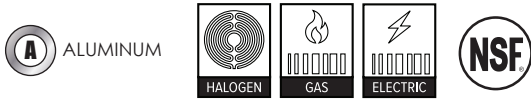

ITEM	DESCRIPTION	U/M	WEIGHT GROSS lbs	INNER PACK	MASTER PACK	CU. FT.
ALSKDB001	8 qt, 9½" Diameter x 7½" Height, ⅛" Thickness, Handle: 1⅝", Middle: 8½" Diameter x 8" Height, Lid: 10¼" Diameter x ⅝" Height	SET	6.82	1	1	0.86
ALSKDB002	12 qt, 10¼" Diameter x 9½" Height, ⅛" Thickness, Handle: 1¾", Middle: 9¼" Diameter x 9¼" Height, Lid: 11½" Diameter x ⅝" Height	SET	8.58	1	1	1.15
ALSKDB003	16 qt, 11⅜" Diameter x 10¼" Height, ⅛" Thickness, Handle: 1¾", Middle: 10⅜" Diameter x 9¼" Height, Lid: 12⅝" Diameter x ⅝" Height	SET	9.49	1	1	1.29
ALSKDB004	20 qt, 12¼" Diameter x 11" Height, ⅛" Thickness, Handle: 1⅝", Middle: 11¼" Diameter x 9¾" Height, Lid: 13" Diameter x ⅝" Height	SET	11.00	1	1	1.51



Double Boiler Set  
ALSKDB001~ ALSKDB004

**ALUMINUM TURKEY POT**

Durable mirror-finished, with base strainer/rack, poultry hanger, and lid.



ITEM	DESCRIPTION	U/M	WEIGHT GROSS lbs	INNER PACK	MASTER PACK	CU. FT.
ALSKTP012	26 qt, 11¾" Diameter x 16" Height, Handle: 1¾", Lid: 11¾" x 1" Height, Handle: 1/2", Base Strainer: 9¼" Diameter x 13⅝" Height, Wire Rack Thickness: ¼", Poultry Hanger: 9½" Length x 9" Height, Wire Thickness: ¼"	SET	4.41	1	1	1.75



Turkey Pot  
ALSKTP012

**ANODIZED NON-STICK COATED SAUCE PAN**

Avoid sticky mess and hassles with anodized non-stick coated sauce pan, featuring chrome plated steel cool handle.



ITEM	DESCRIPTION	U/M	WEIGHT GROSS lbs	INNER PACK	MASTER PACK	CU. FT.
ALSS010AC	1 qt, 6" Diameter x 2⅞" Height, 6⅞" Length x 1⅝" Width Handle	EACH	7.05	1	4	0.77
ALSS030AC	3 qt, 8⅝" Diameter x 3⅞" Height, 7⅞" Length x 1⅝" Width Handle	EACH	12.68	1	4	1.74
ALSS050AC	5 qt, 9¾" Diameter x 4⅞" Height, 9⅞" Length x 1¼" Width Handle	EACH	18.74	1	4	2.88



ALSS030AC ALSS010AC

Non-Stick  
Sauce Pans



Non-Stick  
Quantum II Fry Pan  
ALFPEX001C ~ ALFPEX005C

Durable riveted handle.



→ ←  
2.8 ~ 3.5 mm  
Wall Thickness

### ALUMINUM ALLOY FRY PAN

Avoids sticky mess and hassles with these reinforced professional **Quantum 2®** coated fry pans. Made of heavy duty aluminum alloy and durable riveted handle.



ITEM	DESCRIPTION	U/M	WEIGHT GROSS lbs	INNER PACK	MASTER PACK	CU. FT.
ALFPEX001C	7" Diameter x 1 1/8" Height, 5 1/2" Length x 1" Width Handle	EACH	7.70	1	6	0.36
ALFPEX002C	8" Diameter x 1 3/4" Height, 6 1/4" Length x 7/8" Width Handle	EACH	9.91	1	6	0.57
ALFPEX003C	10" Diameter x 2" Height, 7 3/8" Length x 7/8" Width Handle	EACH	15.43	1	6	0.88
ALFPEX004C	12" Diameter x 2 1/8" Height, 9 7/8" Length x 1 1/8" Width Handle	EACH	22.03	1	6	1.36
ALFPEX005C	14" Diameter x 2 1/2" Height, 11 3/4" Length x 1 1/8" Width Handle	EACH	26.90	1	6	1.91

**\*\* With 3 layer Quantum 2 non-stick coating.**

### ALUMINUM ALLOY FRY PAN

Made of heavy duty aluminum alloy and durable riveted handle. Available in brushed aluminum interior surface and 2 layer non-stick coating.



Fry Pan  
ALSKFP001C ~ ALSKFP005C



Non-Stick Fry Pan  
ALSKFP101C ~ ALSKFP105C

→ ←  
2.8 ~ 3.5 mm  
Wall Thickness

ITEM	DESCRIPTION	U/M	WEIGHT GROSS lbs	INNER PACK	MASTER PACK	CU. FT.
<b>Natural</b>						
ALSKFP001C	7" Diameter x 1 1/8" Height, 5 1/2" Length x 1" Width Handle	EACH	8.80	1	6	0.36
ALSKFP002C	8" Diameter x 1 3/4" Height, 6 1/4" Length x 7/8" Width Handle	EACH	9.91	1	6	0.57
ALSKFP003C	10" Diameter x 1 1/8" Height, 7 3/8" Length x 7/8" Width Handle	EACH	14.00	1	6	0.88
ALSKFP004C	12" Diameter x 2 1/8" Height, 9 7/8" Length x 1 1/8" Width Handle	EACH	22.03	1	6	1.36
ALSKFP005C	14" Diameter x 2 1/2" Height, 11 3/4" Length x 1 1/8" Width Handle	EACH	29.10	1	6	1.91

**\*\* With brushed aluminum interior (Non-Stick)**

ALSKFP101C	7" Diameter x 1 1/8" Height, 5 1/2" Length x 1" Width Handle	EACH	8.81	1	6	0.36
ALSKFP102C	8" Diameter x 1 3/4" Height, 6 1/4" Length x 7/8" Width Handle	EACH	9.91	1	6	0.57
ALSKFP103C	10" Diameter x 2" Height, 7 3/8" Length x 7/8" Width Handle	EACH	15.42	1	6	0.88
ALSKFP104C	12" Diameter x 2" Height, 9 7/8" Length x 1 1/8" Width Handle	EACH	22.03	1	6	1.36
ALSKFP105C	14" Diameter x 2 1/2" Height, 11 3/4" Length x 1 1/8" Width Handle	EACH	29.10	1	6	1.91

**\*\* With 2 layer non-stick coating.**

### HEAT RESISTANT SILICONE COOL HANDLE

Use as extra precaution when handling hot cookware. Black color. Handle comes with hook piercing. Reusable and interchangeable. Easy to wash. Operating temperature from -5° C to 180° C.



Cool Handle  
PLTWRH078C  
PLTWRH112C  
PLTWRH114C

ITEM	DESCRIPTION	U/M	WEIGHT GROSS lbs	INNER PACK	MASTER PACK	CU. FT.
<b>Silicone Cool Handle</b>						
PLTWRH078C	Fits 7" & 8" - 4 5/8" x 1 1/4" x 1/2"	EACH	9.00	12	120	0.42
PLTWRH112C	Fits 10" - 4 5/8" x 1 1/4" x 1/2"	EACH	14.00	12	120	0.56
PLTWRH114C	Fits 12" & 14" - 4 5/8" x 1 1/4" x 1/2"	EACH	18.00	12	120	0.86

## FRY BASKETS (NICKEL PLATED)

Rectangular baskets fit slimly into the fryer for compact use. Open handle is angled to rest extended on fryer or be hooked on edge.

ITEM	DESCRIPTION	BASKET SIZE	U/M	WEIGHT GROSS lbs	INNER PACK	MASTER PACK	CU. FT.
<b>Round with Cross Support Under</b>							
SLFB001	Fits ALSF003 - Hook: 1 3/8", Handle: 7 3/8" 1 1/2"	11 1/2" Diameter x 5 3/8"	EACH	41.01	1	20	3.42
SLFB002	Fits ALSF002 - Hook: 3/4", Handle: 7 3/8" 1 1/2"	9 1/2" Diameter x 5"	EACH	30.35	1	20	2.38
SLFB003	Fits ALSF001 - Hook: 1 1/8", Handle: 7 1/4" 1 3/8"	8 3/4" Diameter x 5"	EACH	27.65	1	20	2.05
SLFB006	Round Fry Basket - Hook: 1 1/8", Handle: 7 1/4" 1 3/8"	13" Diameter x 5 3/8"	EACH	65.04	1	20	6.23
<b>Rectangular with Cross Support Under</b>							
SLFB004	Green Handle - Open Handle Hook: 3" x 1", Handle: 11 3/8", Height: 2 3/8"	13" x 6 3/8" x 5 3/8"	EACH	28.66	1	12	3.35
SLFB005	Blue Handle - Open Handle Hook: 3" x 3/4", Handle: 10 1/2", Height: 3 3/8"	13 3/8" x 5 3/4" x 5 1/2"	EACH	30.86	1	12	3.81
SLFB007	Gray Handle - Open Handle Hook: 2 3/8" x 3/4", Handle: 9 3/8", Height: 4"	13 1/2" x 4 1/4" x 5 1/2"	EACH	29.98	1	12	3.14
SLFB008	Orange Handle - Open Handle Hook: 3 3/8" x 3/4", Handle: 10 1/4", Height: 3 3/4"	12 1/8" x 6 1/4" x 5 1/4"	EACH	29.01	1	12	3.73
SLFB009	Yellow Handle - Open Handle Hook: 3 3/4" x 7/8", Handle: 12 1/4", Height: 1 3/4"	17" x 8" x 6 3/4"	EACH	21.58	1	6	3.75

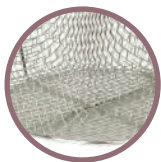

Cross Support

SLFB001  
SLFB002  
SLFB003  
SLFB006



SLFB004



SLFB005



SLFB007

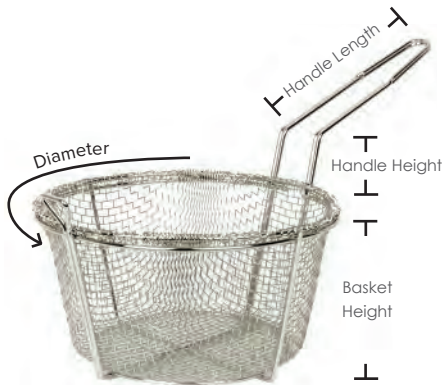

SLFB008



SLFB009



## FRY BASKET PRESS (NICKEL PLATED)

Ensures efficient frying with flat mesh panel press. Elongated arm extends over fry basket for easy reaching. Available in different surface areas for specific usage.

ITEM	DESCRIPTION	U/M	WEIGHT GROSS lbs	INNER PACK	MASTER PACK	CU. FT.
SLFBP010	Green Handle 4 3/4" x 11" Fits SLFB004 & SLFB005	EACH	33.07	1	40	1.74
SLFBP014	Blue Handle 5 3/4" x 14 1/2"	EACH	57.00	1	30	1.43

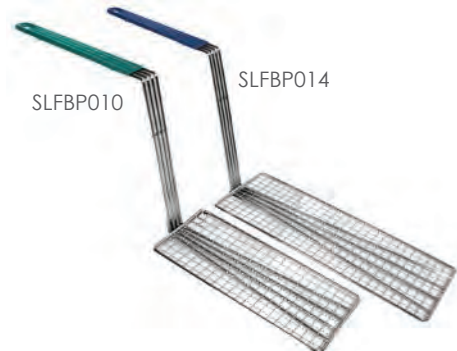

# TABLE TOP SERVICES



TABLE TOP SERVICES



GLTWSS002

## MUSHROOM CAP SQUARE SHAKER

A rectangle glass body, complemented by a mushroom cap lid. Ideal for various spice storage in the kitchen or on the table.

ITEM	DESCRIPTION	U/M	WEIGHT GROSS lbs	INNER PACK	MASTER PACK	CU. FT.
GLTWSS002	2 oz, 1 1/2" Diameter x 4" Height	DOZEN	35.20	2	12	1.40



GLTWPS001 GLTWPS002

## PANELED SHAKER

Glass paneled shakers with stainless steel lids. A cozy touch to any table setting.

ITEM	DESCRIPTION	U/M	WEIGHT GROSS lbs	INNER PACK	MASTER PACK	CU. FT.
GLTWPS001	1 oz, 1 1/2" Diameter x 2 3/4" Height	DOZEN	44.88	2	24	1.65
GLTWPS002	1 1/4 oz, 1 5/8" Diameter x 3 3/8" Height	DOZEN	39.60	2	24	2.00
GLTWSS003	3 oz, 1 3/8" (Diameter Top) 2 1/8" Diameter x 4 1/2" Height	DOZEN	45.64	1.00	12	2.77



GLTWSS003

## SWIRL CHEESE SHAKER

Stores cheese powder in convenient and easy-to-identify clear glass shakers. Lids available in stainless steel slotted or perforated. Holds 6 oz of cheese powder ready for table use.

ITEM	DESCRIPTION	U/M	WEIGHT GROSS lbs	INNER PACK	MASTER PACK	CU. FT.
<b>Slotted</b>						
GLTWCS006	6 oz, 2 3/4" Diameter x 3 1/2" Height Stainless Steel	DOZEN	44.09	1	8	2.53
<b>Perforated</b>						
GLTWCS006P	6 oz, 2 3/4" Diameter x 3 1/2" Height Stainless Steel	DOZEN	44.09	1	8	2.53
PLTWCS006	6 oz, 2 3/4" Diameter x 3 1/2" Height S/S Perforated Swirl Polycarbonate	DOZEN	16.54	1	12	2.30



GLTWCS006



GLTWCS006P



PLTWCS006 (Polycarbonate)

## CUBE SALT & PEPPER SHAKER

A convenient addition to any cozy table setting.

ITEM	DESCRIPTION	U/M	WEIGHT GROSS lbs	INNER PACK	MASTER PACK	CU. FT.
GLTWCC005	1/2 oz, 1 1/2" x 1 1/2" x 3" Stainless Steel Top	DOZEN	46.30	4	48	2.10
GLTWCC205	1/2 oz, 1 1/2" x 1 1/2" x 3" Gold Top	DOZEN	46.30	4	48	2.10



GLTWCC005

GLTWCC205

## TOWER SHAKER

A slim accent to salt and pepper on the table.

ITEM	DESCRIPTION	U/M	WEIGHT GROSS lbs	INNER PACK	MASTER PACK	CU. FT.
GLTWTS001	1 oz, 1 7/8" Diameter x 4 1/4" Height Hole: 1.5mm, Stainless Steel Top	DOZEN	34.39	2	12	2.60
GLTWTS201	1 oz, 1 7/8" Diameter x 4 3/8" Height Hole: 1.5mm, Gold Top	DOZEN	34.39	2	12	2.60



GLTWTS001

GLTWTS201



**OIL & VINEGAR CRUET**

Square glass bottle with elongated neck. Easy to refill and clean.

ITEM	DESCRIPTION	U/M	WEIGHT GROSS lbs	INNER PACK	MASTER PACK	CU. FT.
GLTWOC006	6 oz Stainless Steel Top 2½" x 2½" x 5½" Height	DOZEN	35.27	1	6	2.20
GLTWOC206	6 oz Gold Top 2½" x 2½" x 5½" Height	DOZEN	35.27	1	6	2.20



**SYRUP DISPENSER**

Glass dispenser with cast zinc top that easily opens to pour syrups, juices, dressings and milk. Easy to clean and refill. Open handle made for quick use.

ITEM	DESCRIPTION	U/M	WEIGHT GROSS lbs	INNER PACK	MASTER PACK	CU. FT.
GLTWSY006	6 oz, 2¾" Diameter x 4½" Height	DOZEN	35.27	2	8	2.87
GLTWSY014	14 oz, 3¾" Diameter x 5¾" Height	DOZEN	30.86	1	2	1.72



**SUGAR/CHEESE DISPENSER**

Attractive fluted glass dispensers with stainless steel perforated, flip, or center holed caps. Ideal for holding sugar and cheese. Easy to refill and clean.

ITEM	DESCRIPTION	U/M	WEIGHT GROSS lbs	INNER PACK	MASTER PACK	CU. FT.
GLTWSJ012	12 oz, Flip Cap Top 3" Diameter x 5½" Height	DOZEN	42.99	2	4	2.41
GLTWSJ012H	12 oz, Single Hole Top 3" Diameter x 5½" Height	DOZEN	41.89	2	4	2.20
GLTWSJ012P	12 oz, Perforated Top 3" Diameter x 5½" Height	DOZEN	41.89	2	4	2.20



**ACRYLIC STIRRER, STRAW & TOOTHPICK DISPENSER**

Crystal clear acrylic dispenser with easy lift top for refills. Rectangular shapes nestles perfectly on counter-top corners. For containing and safely dispensing stirrers, straws, & toothpicks.

Made in Taiwan

ITEM	DESCRIPTION	U/M	WEIGHT GROSS lbs	INNER PACK	MASTER PACK	CU. FT.
PLSD001	7¾" x 4½" x 5¾"	EACH	17.60	1	12	1.75
PLSD002	12¾" x 5¾" x 6¾"	EACH	21.83	1	6	2.50
PLTD003	3¾" x 3¾" x 4¾"	EACH	32.12	1	36	2.50

PLSD001  
Stirrer  
Dispenser



PLTD003  
Toothpick  
Dispenser



PLSD002  
Straw  
Dispenser



**STAINLESS STEEL NAPKIN DISPENSER**

Stands upright on table tops and counter tops for fast and easy use. Easy to refill and keeps napkins organized.

SS STAINLESS STEEL

ITEM	DESCRIPTION	U/M	WEIGHT GROSS lbs	INNER PACK	MASTER PACK	CU. FT.
SLNH001	3¾" x 4½" x 7½" Napkin Dispenser - Tall	EACH	41.89	1	36	3.14
SLNH002	3¾" x 4½" x 5¾" Napkin Dispenser - Short	EACH	30.86	1	36	2.49

SLNH001



SLNH002



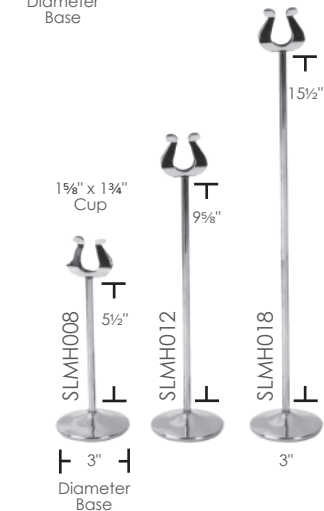
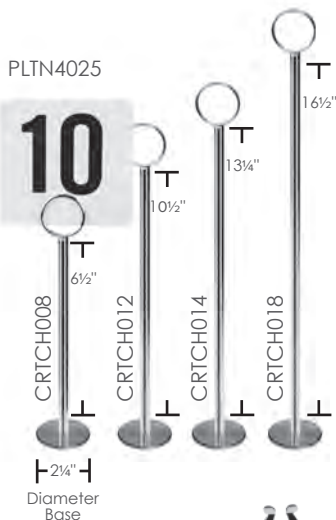

\*\* Holder, Jar, Cover sold separately \*\*



### CHROME TABLE CARD STAND & NUMBER CARDS

Present cards on a balanced chrome plated card holder.

ITEM	DESCRIPTION	U/M	WEIGHT GROSS lbs	INNER PACK	MASTER PACK	CU. FT.
<b>Table Card Stands</b>						
CRTCH008	8" - 2 1/4" Diameter Base, 6 1/2" Pole Length, 1 1/4" Diameter Ring	EACH	35.20	12	120	1.40
CRTCH012	12" - 2 1/4" Diameter Base, 10 1/2" Pole Length, 1 1/4" Diameter Ring	EACH	40.00	12	120	1.98
CRTCH014	14 1/2" - 2 1/4" Diameter Base, 13 3/4" Pole Length, 1 1/4" Diameter Ring	EACH	44.09	12	120	2.37
CRTCH018	18" - 2 1/4" Diameter Base, 16 1/2" Pole Length, 1 1/4" Diameter Ring	EACH	48.50	12	120	2.95
<b>Plastic Table Numbers 4" x 4"</b>						
PLTN4025	Number 1~25	PACK	38.00	20	200	0.71
PLTN4050	Number 1~50	PACK	38.00	10	100	0.86
PLTN4100	Number 1~100	PACK	37.50	1	50	0.75

### TABLE CARD STAND

Slim rod on a heavy base.



ITEM	DESCRIPTION	U/M	WEIGHT GROSS lbs	INNER PACK	MASTER PACK	CU. FT.
SLMH008	8" Overall Length, 3" Diameter Base, 5 1/2" Pole Length, 1 5/8" x 1 3/4" Cup	DOZEN	50.71	1	8	2.73
SLMH012	12" Overall Length, 3" Diameter Base, 9 5/8" Pole Length, 1 5/8" x 1 3/4" Cup	DOZEN	37.48	1	5	2.49
SLMH018	18" Overall Length, 3" Diameter Base, 15 1/2" Pole Length, 1 5/8" x 1 3/4" Cup	DOZEN	39.68	1	4	2.89

### CONDIMENT JAR, SALT & PEPPER/SUGAR PACKET HOLDER

ITEM	DESCRIPTION	U/M	WEIGHT GROSS lbs	INNER PACK	MASTER PACK	CU. FT.
<b>Stainless Steel Holder</b>						
SLCJH002	2 Holes, 6 3/8" x 3 3/8" x 7 7/8" Hole Size: 3 3/8" Diameter	EACH	24.20	12	72	3.68
SLCJH003	3 Holes, 7 1/8" x 6" x 8" Hole Size: 3 3/8" Diameter	EACH	22.05	12	48	5.74
SLCJH004	4 Holes, 6 7/8" x 6 1/8" x 7 1/2" Hole Size: 3 3/8" Diameter	EACH	26.46	12	48	5.61
<b>Jar &amp; Cover</b>						
GLCJ007	7 oz Glass Jar 3 1/8" Diameter x 2 7/8" Height	EACH	30.80	48	48	1.10
PLCJ007	7 oz Plastic Jar w/Cover 3" Diameter x 3 3/8" Height	EACH	14.30	12	96	2.11
PLCJ007C	3" Diameter x 7/8" Height, Condiment Cover fits PLCJ007	EACH	14.11	12	300	1.07
SLCJ007C	3 3/8" Diameter x 7/8" Height, Condiment Cover fits SLCJ007	EACH	20.94	24	144	0.92
<b>Sugar Packet Holder</b>						
CRSP435	Sugar Packet Holder 4 1/2" x 3 1/2" x 5 1/2"	EACH	18.08	12	48	1.86
CRSP956	Salt & Pepper / Sugar Packet Holder 9" x 5" x 5 3/4"	EACH	24.56	12	48	3.99

**SUGAR PACKET HOLDER**



PLSP032BK



PLSP032CH



PLSP032CL



PLSP032WT

ITEM	DESCRIPTION	U/M	WEIGHT GROSS lbs	INNER PACK	MASTER PACK	CU. FT.
PLSP032BK	Black, 3½" x 2½" x 2"	DOZEN	16.53	2	10	1.22
PLSP032CH	Brown, 3½" x 2½" x 2"	DOZEN	16.53	2	10	1.22
PLSP032CL	Clear, 3½" x 2½" x 2"	DOZEN	16.53	2	10	1.22
PLSP032WT	White, 3½" x 2½" x 2"	DOZEN	16.53	2	10	1.22

**MENU HOLDER**

Perfect for displaying menus, business cards, and other information cards.



SLTWMH004



SLTWMH006



SLMH001



SLMH002



SLRMH003

ITEM	DESCRIPTION	U/M	WEIGHT GROSS lbs	INNER PACK	MASTER PACK	CU. FT.
SLTWMH004	2½" Diameter x 2" Height, Ring Shape	EACH	29.70	72	720	2.68
SLTWMH006	2½" Diameter x 2½" Height,	EACH	31.90	72	720	2.68
SLMH001	1" Diameter x 1½" Height, Harp Shape	EACH	37.00	120	720	0.62
SLMH002	2¼" Diameter x 2" Height, Ring Shape	EACH	30.90	24	288	1.18
SLRMH003	2¼" Diameter x 2¼" Height, Ring Shape	EACH	23.10	24	240	1.32

**PLASTIC TABLE CARD HOLDER**

Acrylic table card holders with sturdy flat plane insert perpendicular to flat base.

Made in Taiwan

ITEM	DESCRIPTION	U/M	WEIGHT GROSS lbs	INNER PACK	MASTER PACK	CU. FT.
PLMH001	5½" x 3½", 2 mm Thickness	EACH	18.30	12	72	1.70
PLMH002	4" x 6", 2 mm Thickness	EACH	20.24	12	72	1.79
PLMH003	5" x 7", 2 mm Thickness	EACH	18.74	12	48	1.80
PLMH004	8½" x 11", 2 mm Thickness	EACH	28.22	6	24	2.30



**MENU COVER**

Protects papers with a flexible plastic laminate folder.



PLMENU-L3BL



ITEM	DESCRIPTION	U/M	WEIGHT GROSS lbs	INNER PACK	MASTER PACK	CU. FT.
<b>3 Page Book Fold</b>						
PLMENU-L3BL	8½" x 11" - Black	EACH	22.05	10	50	1.22
PLMENU-L3BR	8½" x 11" - Brown	EACH	22.05	10	50	1.22
PLMENU-L3GR	8½" x 11" - Green	EACH	22.05	10	50	1.22
PLMENU-L3MA	8½" x 11" - Maroon	EACH	22.05	10	50	1.22



PLMENU-L4MA

ITEM	DESCRIPTION	U/M	WEIGHT GROSS lbs	INNER PACK	MASTER PACK	CU. FT.
<b>4 Page Book Fold</b>						
PLMENU-L4BL	8½" x 11" - Black	EACH	28.66	10	50	1.61
PLMENU-L4BR	8½" x 11" - Brown	EACH	28.66	10	50	1.61
PLMENU-L4GR	8½" x 11" - Green	EACH	28.66	10	50	1.61
PLMENU-L4MA	8½" x 11" - Maroon	EACH	28.66	10	50	1.61
PLMENU-4	8½" x 14" - Black (long)	EACH	35.27	10	50	1.26
PLMENU-4BR	8½" x 14" - Brown (long)	EACH	35.27	10	50	1.26



PLMENU-6GR

ITEM	DESCRIPTION	U/M	WEIGHT GROSS lbs	INNER PACK	MASTER PACK	CU. FT.
<b>6 Page Book Fold</b>						
PLMENU-6TGI	7½" x 13¼" - Black (long)	EACH	46.96	10	50	3.77
PLMENU-6BL	8½" x 11" - Black	EACH	45.20	10	50	3.08
PLMENU-6BR	8½" x 11" - Brown	EACH	45.20	10	50	3.08
PLMENU-6GR	8½" x 11" - Green	EACH	45.20	10	50	3.08
PLMENU-6MA	8½" x 11" - Maroon	EACH	45.20	10	50	3.08

ITEM	DESCRIPTION	U/M	WEIGHT GROSS lbs	INNER PACK	MASTER PACK	CU. FT.
<b>Single Menu Cover</b>						
PLMENU-1BL	8½" x 11" - Black	EACH	8.82	10	50	0.44
PLMENU-1BR	8½" x 11" - Brown	EACH	8.82	10	50	0.44
PLMENU-1GR	8½" x 11" - Green	EACH	8.82	10	50	0.44
PLMENU-1MA	8½" x 11" - Maroon	EACH	8.82	10	50	0.44



PLMENU-1GR

ITEM	DESCRIPTION	U/M	WEIGHT GROSS lbs	INNER PACK	MASTER PACK	CU. FT.
<b>Double Fold Menu Cover</b>						
PLMENU-2BL	8½" x 11" - Black	EACH	15.43	10	50	0.84
PLMENU-2BR	8½" x 11" - Brown	EACH	15.43	10	50	0.84
PLMENU-2GR	8½" x 11" - Green	EACH	15.43	10	50	0.84
PLMENU-2MA	8½" x 11" - Maroon	EACH	15.43	10	50	0.84



PLMENU-2GR

ITEM	DESCRIPTION	U/M	WEIGHT GROSS lbs	INNER PACK	MASTER PACK	CU. FT.
<b>Triple Fold Menu Cover</b>						
PLMENU-3BL	8½" x 11" - Black	EACH	22.05	10	50	1.25
PLMENU-3BR	8½" x 11" - Brown	EACH	22.05	10	50	1.25
PLMENU-3GR	8½" x 11" - Green	EACH	22.05	10	50	1.25
PLMENU-3MA	8½" x 11" - Maroon	EACH	22.05	10	50	1.25



PLMENU-3GR

**CHECK PRESENTATION COVER**

Black or brown cover with pocket inserts to hold checks, cash, and credit cards. "Thank You" wording is imprinted in gold color on the front cover.

ITEM	DESCRIPTION	U/M	WEIGHT GROSS lbs	INNER PACK	MASTER PACK	CU. FT.
PCPC-1BL	5¾" x 9½" - Black	EACH	17.64	10	50	1.28
PCPC-1BR	5¾" x 9½" - Brown	EACH	17.64	10	50	1.28



PCPC-1BL



PCPC-1BR



PLPT046BL



PLPT046BR

### PLASTIC TIP TRAY

"Thank You" wording imprinted in gold color. Can be used with Check Presentation Cover.

ITEM	DESCRIPTION	U/M	WEIGHT GROSS lbs	INNER PACK	MASTER PACK	CU. FT.
PLPT046BL	4½" x 6½" x ¼" - Black	DOZEN	37.80	4	24	1.24
PLPT046BR	4½" x 6½" x ¼" - Brown	DOZEN	37.80	4	24	1.24

### NO CLIP CHECK HOLDER

Displays paper slips in an orderly arranged manner, without clips.

Made in Taiwan



SLTWCH018

ITEM	DESCRIPTION	U/M	WEIGHT GROSS lbs	INNER PACK	MASTER PACK	CU. FT.
SLTWCH018	18" x 3½" x ¾"	EACH	54.01	12	48	1.20
SLTWCH024	24" x 3½" x ¾"	EACH	37.00	12	24	0.80
SLTWCH030	30" x 3½" x ¾"	EACH	44.00	12	24	1.00
SLTWCH036	36" x 3½" x ¾"	EACH	52.14	12	24	1.15
SLTWCH044	44" x 3½" x ¾"	EACH	63.80	12	24	1.47

### CHECK SPINDLE

Tri-pod circular base with stem. Gold finish.



SLSPIN001

ITEM	DESCRIPTION	U/M	WEIGHT GROSS lbs	INNER PACK	MASTER PACK	CU. FT.
SLSPIN001	3½" Diameter x 6" Height	EACH	31.53	12	240	3.20

### TABLE BELL

For a quick alert at the desk or at the counter.



SLBELL001



ITEM	DESCRIPTION	U/M	WEIGHT GROSS lbs	INNER PACK	MASTER PACK	CU. FT.
SLBELL001	3¾" Diameter x 2¼" Height	EACH	41.89	12	144	3.05

### GRAVY BOAT

Mirror finish. Tapered spout helps prevent dripping. Contoured handle, securely welded to the base for easy pouring.



SLGB003 ~ SLGB008

ITEM	DESCRIPTION	U/M	WEIGHT GROSS lbs	INNER PACK	MASTER PACK	CU. FT.
SLGB003	3 oz, 5½" x 2½" x 3"	EACH	11.23	6	48	0.95
SLGB005	5 oz, 7½" x 3" x 2¾"	EACH	15.43	6	48	1.45
SLGB008	8 oz, 8¼" x 3½" x 3¼"	EACH	22.05	6	48	2.32

### SYRUP PITCHER

Clear plastic syrup pitcher with paneled surface. Easy to clean and reusable.

ITEM	DESCRIPTION	U/M	WEIGHT GROSS lbs	INNER PACK	MASTER PACK	CU. FT.
PLSP002D	2 oz, 2¼" Diameter x 2" Height	DOZEN	40.12	9	54	2.60



PLSP002D

### SAUCE CUP



ITEM	DESCRIPTION	U/M	WEIGHT GROSS lbs	INNER PACK	MASTER PACK	CU. FT.
SLSA001	1½ oz, 2¾" Diameter x 1" Height	EACH	29.10	12	576	0.83
SLSA002	2½ oz, 2½" Diameter x 1½" Height	EACH	36.70	12	576	0.94
SLSA003	3 oz, 2¾" Diameter x 1½" Height	EACH	25.37	12	288	0.57
SLSA004	4 oz, 2¾" Diameter x 2" Height	EACH	27.57	12	288	0.68



SLSA001



SLSA002



SLSA003



SLSA004

### RAMEKIN, BONE

ITEM	DESCRIPTION	U/M	WEIGHT GROSS lbs	INNER PACK	MASTER PACK	CU. FT.
PLRM005W	5 oz, Fluted, Bone, 3½" Diameter x 1½" Height ABS	DOZEN	46.74	4	36	2.84



PLRM005W

### EGG CUP

Perfect for any restaurant that is looking for a way to display and hold a perfectly cooked soft boiled egg.



ITEM	DESCRIPTION	U/M	WEIGHT GROSS lbs	INNER PACK	MASTER PACK	CU. FT.
SLEC001	2" x 2½" Height	EACH	21.03	12	288	1.84
SLEC002	2" x 1½" Height	EACH	16.98	12	288	1.45



SLEC001



SLEC002

### FRY CUP

Serve your french fries, breadsticks, pretzels, or other snacks in style.



ITEM	DESCRIPTION	U/M	WEIGHT GROSS lbs	INNER PACK	MASTER PACK	CU. FT.
SLFFC001	13 oz, Satin 3¾" Diameter x 3¾" Height	EACH	17.66	12	48	0.46
SLFFC003	13 oz, Hammered 3¾" Diameter x 3¾" Height	EACH	17.77	12	48	0.46
SLFFC005	14 oz, Mirror, Angled 3½" Diameter x 4½" Height	EACH	19.78	12	48	0.58



SLFFC001



SLFFC003



SLFFC005

### PIZZA STAND

Chrome plated wire pizza tray stand.

ITEM	DESCRIPTION	U/M	WEIGHT GROSS lbs	INNER PACK	MASTER PACK	CU. FT.
CRPTS997	Pizza Tray Stand 9½" x 9" x 6½"	EACH	33.07	12	24	1.34



CRPTS997



SLGT008 ~ SLGT120

↓ 0.63 ~ 0.7 mm  
↑ Wall Thickness

### OVAL AU GRATIN DISH

Oval stainless steel au gratin dish with a groove to hold in crumbs or toppings for an elegant presentation.



ITEM	DESCRIPTION	U/M	WEIGHT GROSS lbs	INNER PACK	MASTER PACK	CU. FT.
SLGT008	8 oz, 8" x 3 <sup>7</sup> / <sub>8</sub> " x 1"	EACH	42.00	12	144	0.94
SLGT012	12 oz, 9 <sup>1</sup> / <sub>4</sub> " x 5" x 1"	EACH	48.00	12	144	1.40
SLGT020	20 oz, 10 <sup>5</sup> / <sub>8</sub> " x 6 <sup>1</sup> / <sub>2</sub> " x 1 <sup>1</sup> / <sub>4</sub> "	EACH	35.27	12	72	0.85
SLGT108	8 oz, 7 <sup>7</sup> / <sub>8</sub> " x 4 <sup>3</sup> / <sub>8</sub> " x 1"	EACH	39.60	12	144	0.88
SLGT112	12 oz, 9" x 4 <sup>3</sup> / <sub>8</sub> " x 1 <sup>1</sup> / <sub>4</sub> "	EACH	44.00	12	144	1.00
SLGT120	20 oz, 10 <sup>7</sup> / <sub>8</sub> " x 6 <sup>1</sup> / <sub>2</sub> " x 1"	EACH	35.71	12	72	0.81



SLSSD003



SLSSD005

### SHERBET DISH

Serve ice-cream, sherbet or any frozen desserts. Stands on a flat base with a mirror polish.



ITEM	DESCRIPTION	U/M	WEIGHT GROSS lbs	INNER PACK	MASTER PACK	CU. FT.
SLSSD003	3 <sup>1</sup> / <sub>2</sub> oz, 3 <sup>3</sup> / <sub>4</sub> " Diameter x 1 <sup>1</sup> / <sub>2</sub> " Height	EACH	23.00	12	144	2.51
SLSSD005	5 oz, 4 <sup>1</sup> / <sub>2</sub> " x Diameter x 1 <sup>5</sup> / <sub>8</sub> " Height	EACH	28.00	12	144	3.40



SLBW004

### BUTTER WARMER SET

A 3 piece set with stainless steel base, warmer pan, and glass flame holder.

ITEM	DESCRIPTION	U/M	WEIGHT GROSS lbs	INNER PACK	MASTER PACK	CU. FT.
SLBW004	O/A: 3 <sup>1</sup> / <sub>2</sub> " Diameter x 5 <sup>1</sup> / <sub>2</sub> " Height Dish: 3 <sup>1</sup> / <sub>2</sub> " Diameter x 1" Height Glass Holder: Diameter x 2 <sup>1</sup> / <sub>4</sub> " Height	SET	45.19	1	48	2.78



SLRCD001

### COFFEE DECANTER

Open rimmed mirror finish stainless steel with black easy-grip handle.

ITEM	DESCRIPTION	U/M	WEIGHT GROSS lbs	INNER PACK	MASTER PACK	CU. FT.
SLRCD001	64 oz Coffee Decanter 6" Diameter x 6 <sup>5</sup> / <sub>8</sub> " Height, 1 <sup>3</sup> / <sub>8</sub> " Handle Length	EACH	21.25	1	12	2.76
SLTCD012	12 oz Turkish Coffee Decanter 3 <sup>1</sup> / <sub>2</sub> " Diameter x 3 <sup>1</sup> / <sub>2</sub> " Height, 4 <sup>3</sup> / <sub>4</sub> " Handle Length	EACH	12.13	6	24	1.08
SLTCD024	24 oz Turkish Coffee Decanter 4 <sup>1</sup> / <sub>2</sub> " Diameter x 4 <sup>1</sup> / <sub>2</sub> " Height, 5 <sup>1</sup> / <sub>2</sub> " Handle Length	EACH	16.50	6	24	1.72



SLTCD024

SLTCD012



**WATER PITCHER with ICE GUARD**

Added ice guard to prevent spilling of water and ice.



ITEM	DESCRIPTION	U/M	WEIGHT GROSS lbs	INNER PACK	MASTER PACK	CU. FT.
SLWP064	64 oz, 4¾" Diameter 7¾" Height, 4¼" Length x 2¼" Width Handle (1¾" Grip Space)	EACH	17.64	1	12	2.43
SLME266	66 oz, 5½" Diameter 6½" Height, 4¼" Length x 2¼" Width Handle (1¾" Grip Space)	EACH	44.09	1	24	3.99



SLWP064



SLME266

**CREAMER**

Creamer in mirror polished stainless steel.



ITEM	DESCRIPTION	U/M	WEIGHT GROSS lbs	INNER PACK	MASTER PACK	CU. FT.
SLFCR005	5 oz Footed Creamer w/ Lid 2½" Diameter x 3½" Height	EACH	40.75	12	144	3.90
<b>Bell Creamer</b>						
SLRBC001	3 oz, 1" Base Diameter x 2¼" Height, 2" Length x 1" Width Handle, 1½" Grip Space	EACH	18.00	12	144	1.59
SLRBC002	5 oz, 1¾" Base Diameter x 2½" Height, 1¾" Length x ¾" Width Handle, 1½" Grip Space	EACH	26.00	12	144	2.07
SLRBC003	8 oz, 2½" Base Diameter x 3" Height, 1½" Length x ¾" Width Handle, 1½" Grip Space	EACH	33.00	12	144	3.29



SLFCR005



SLRBC001 ~ SLRBC003

**MILK PITCHER**

Milk pitcher in mirror polished stainless steel. Good for maintaining milk temperature, cold or hot.



ITEM	DESCRIPTION	U/M	WEIGHT GROSS lbs	INNER PACK	MASTER PACK	CU. FT.
<b>Frothing</b>						
SLME012	12 oz, 2¾" Base Diameter x 4½" Height, 2¾" Length x ⅝" Width Handle (1⅝" Hand Grip Space)	EACH	11.02	1	24	0.87
SLME020	20 oz, 3⅝" Base Diameter x 4½" Height, 2⅞" Length x 1¼" Width Handle (1⅝" Hand Grip Space)	EACH	17.64	1	24	1.37
SLME033	33 oz, 3⅝" Base Diameter x 5" Height, 3½" Length x ⅝" Width Handle (1⅝" Hand Grip Space)	EACH	22.05	1	24	1.85
SLME050	50 oz, 3¾" Base Diameter x 6½" Height, 4½" Length x ¾" Width Handle (1½" Hand Grip Space)	EACH	29.76	1	24	3.21
SLME066	66 oz, 5½" Base Diameter x 6¾" Height, 2½" Length x ¾" Width Handle (2" Hand Grip Space)	EACH	19.84	1	12	2.02
<b>Espresso Engraved with measuring scale</b>						
SLMP0018	18 oz, 3½" Base Diameter x 4½" Height, 2⅞" Length x ¾" Width Handle (1¼" Hand Grip Space)	EACH	17.99	1	24	1.29
SLMP0024	24 oz, 3⅝" Base Diameter x 4⅝" Height, 3⅝" Length x ¾" Width Handle (1¼" Hand Grip Spac	EACH	22.00	1	24	1.88
SLMP0040	40 oz, 4¼" Base Diameter x 5½" Height, 3⅝" Length x ⅔" Width Handle (1½" Hand Grip Spac	EACH	27.02	1	24	2.62

SLME012 ~ SLME066

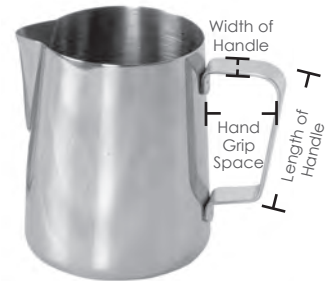

SLMP0018 ~ SLMP0040

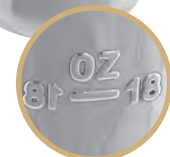



SLCF001



SLCF003  
(Inner)



SLCF002  
(Lid)



### COFFEE DRIPPER

Stainless steel coffee maker with filter, inner part, and lid. Brews coffee without the need for electricity. Quick and efficient.



ITEM	DESCRIPTION	U/M	WEIGHT GROSS lbs	INNER PACK	MASTER PACK	CU. FT.
SLCF001	Coffee Drainer Set 3 3/4" Diameter x 2 1/2" Height	EACH	33.95	12	144	3.94
SLCF002	Lid Only 2 1/2" Diameter x 1/4" Thickness	EACH	34.10	1000	1000	1.03
SLCF003	Inner Part 2 1/4" Diameter x 1 1/2" Height	EACH	28.66	500	500	1.54

### MILK SERVER



SLSR010TP



SLSR210

ITEM	DESCRIPTION	U/M	WEIGHT GROSS lbs	INNER PACK	MASTER PACK	CU. FT.
SLSR010TP	10 oz, 2 1/2" Diameter Base x 4 1/8" Height, 3 1/8" Length x 1/2" Width Handle (1 1/2" Grasp)	EACH	35.00	6	72	2.19
SLSR210	10 oz, 2 1/2" Diameter Base x 3 3/8" Height, 1 5/8" Length x 1/4" Width Handle (1 5/8" Grasp)	EACH	24.00	6	72	1.82

### TEA BALL

With chain and mesh lining. Keeps tea leaves residue in the ball while extracting tea.



SLTB001 ~ SLTB004



SLTB006



SLTB005

ITEM	DESCRIPTION	U/M	WEIGHT GROSS lbs	INNER PACK	MASTER PACK	CU. FT.
SLTB001	2" Diameter x 1 3/8" Height	EACH	15.43	12	288	1.53
SLTB002	2 1/4" Diameter x 2 1/2" Height	EACH	26.40	12	288	3.30
SLTB003	3 1/8" Diameter x 2 5/8" Height	EACH	33.88	12	288	5.05
SLTB004	3 1/2" Diameter x 2 3/4" Height	EACH	38.58	12	288	6.77
SLTB005	4 3/8" Diameter x 4" Height	EACH	37.48	12	120	6.62
SLTB006	5 1/4" Diameter x 4 1/4" Height	EACH	13.75	1	36	2.81

### DRIP TRAY



ALDT045



ALDT060

ITEM	DESCRIPTION	U/M	WEIGHT GROSS lbs	INNER PACK	MASTER PACK	CU. Ft.
ALDT045	4 1/2" x 4 1/2" x 5/8", Hexagon Drip Tray Pack of 4	PACK	12.60	12	24	1.06
ALDT060	5 1/2" x 5 1/2" x 5/8", Hexagon Drip Tray Pack of 4	PACK	16.50	12	24	1.77

### TABLE TENT SIGN

3" x 1 1/2" Stainless steel tent sign displays.



ITEM	DESCRIPTION	U/M	WEIGHT GROSS lbs	INNER PACK	MASTER PACK	CU. Ft.
SLTS3151	Blank, 3" x 1 1/2" x 1 3/8"	EACH	19.40	24	240	0.12
SLTS3152	Hot Tea, 3" x 1 1/2" x 1 3/8"	EACH	19.40	24	240	0.12
SLTS3153	Decaf, 3" x 1 1/2" x 1 3/8"	EACH	19.40	24	240	0.12
SLTS3154	Coffee, 3" x 1 1/2" x 1 3/8"	EACH	19.40	24	240	0.12
SLTS3155	Hot Water, 3" x 1 1/2" x 1 3/8"	EACH	19.40	24	240	0.12
SLTS3156	Iced Tea, 3" x 1 1/2" x 1 3/8"	EACH	19.40	24	240	0.12

**COFFEE DECANTER**

64 oz. coffee decanter in a polycarbonate body on a stainless steel base for added support and more resistant to breakage. Durable plastic handles color coded in black for regular and orange for decaf.



ITEM	DESCRIPTION	U/M	WEIGHT GROSS lbs	INNER PACK	MASTER PACK	CU. FT.
PLCD064	64 oz, 4" Diameter Base x 7" Height, 4¼" Length x ¾" Width, (3⅛" Grip Space)	EACH	13.54	1	12	2.76
PLCD064D	64 oz, Decaf, 4" Diameter Base x 7" Height, 4¼" Length x ¾" Width, (3⅛" Grip Space)	EACH	13.54	1	12	2.76



**U-SHAPE BRUSH**

Designed to clean coffee decanters. Brush features a curved shape that fits the curve of most standard decanters to help make it easier to clean.

ITEM	DESCRIPTION	U/M	WEIGHT GROSS lbs	INNER PACK	MASTER PACK	CU. FT.
PLCDB001	12¼" Overall, 4¾" x 6¼" Brush with 5½" x 1" Handle	EACH	19.80	12	96	2.85



**COFFEE KNOCK BOX**

This box is designed for repeated hard knocks of a commercial operation. Flared top edges on this knock box makes it versatile on a counter top or recessed into a counter.



ITEM	DESCRIPTION	U/M	WEIGHT GROSS lbs	INNER PACK	MASTER PACK	CU. FT.
SLKB164	6¾" x 6⅞" x 4", 0.6 mm Thickness	EACH	21.23	1	24	3.15
SLKB166	6¾" x 6⅞" x 6", 0.6 mm Thickness	EACH	28.63	1	24	4.72
PLKB001	Knock Bar for SLKB164 / SLKB166, ¾" Diameter x 5⅞"	EACH	5.66	12	96	0.34



**DOUBLE WALL VACUUM SERVER**



ITEM	DESCRIPTION	U/M	WEIGHT GROSS lbs	INNER PACK	MASTER PACK	CU. FT.
TJWB007	0.7 Liter Black/Stainless Carafe	EACH	21.38	1	12	1.59
TJWB010	1 Liter Black/Stainless Carafe	EACH	23.15	1	12	2.03



**CHAIN SIGN**

3½" x 1⅜" - Hang chain signs over beverage container for easy content identification.



ITEM	DESCRIPTION	U/M	WEIGHT GROSS lbs	INNER PACK	MASTER PACK	CU. FT.
SLCS3172	Hot Tea	EACH	19.40	24	240	0.12
SLCS3173	Decaf	EACH	19.40	24	240	0.12
SLCS3174	Coffee	EACH	19.40	24	240	0.12
SLCS3175	Hot Water	EACH	19.40	24	240	0.12
SLCS3176	Iced Tea	EACH	19.40	24	240	0.12

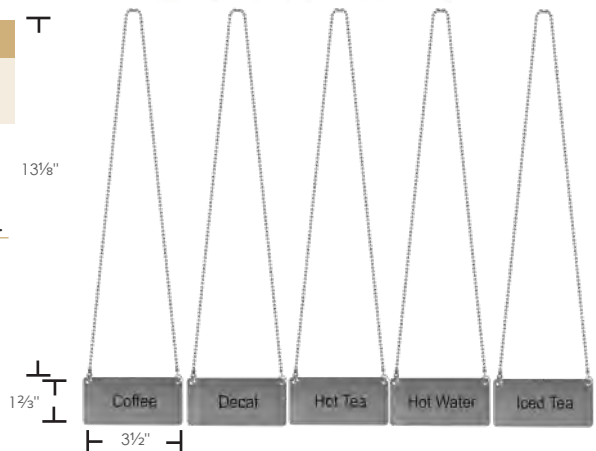

**AIRPOTS**

Made in Taiwan



6 1/4" Diameter



APLG022  
APLG025



Decaf Variant

**GLASS LINER/ PLASTIC EXTERIOR**

ITEM	DESCRIPTION	U/M	WEIGHT GROSS lbs	INNER PACK	MASTER PACK	CU. FT.
<b>Lever Top</b>						
APLG022	2.2 Liter/ 74 oz	EACH	27.06	1	6	2.77
APLG022D	2.2 Liter/ 74 oz Decaf	EACH	27.06	1	6	2.77
APLG025	2.5 Liter/ 84 oz	EACH	29.04	1	6	2.92
APLG025D	2.5 Liter/ 84 oz, Decaf	EACH	29.04	1	6	2.92
<b>Push Button</b>						
APPG022	2.2 Liter/ 74 oz	EACH	27.06	1	6	2.77
APPG022D	2.2 Liter/ 74 oz, Decaf	EACH	27.06	1	6	2.77
APPG025	2.5 Liter/ 84 oz	EACH	29.04	1	6	2.92
APPG025D	2.5 Liter/ 84 oz, Decaf	EACH	29.04	1	6	2.92



**GLASS LINER, STAINLESS STEEL EXTERIOR**



ASLG322  
ASLG325  
ASLG330



3 ID Tags Included

ITEM	DESCRIPTION	U/M	WEIGHT GROSS lbs	INNER PACK	MASTER PACK	CU. FT.
<b>Lever Top</b>						
ASLG322	2.2 Liter/ 74 oz, 6 3/4" Diameter Base x 15 3/4" Overall Height	EACH	27.06	1	6	2.77
ASLG325	2.5 Liter/ 84 oz, 6 3/4" Diameter Base x 16 3/4" Overall Height	EACH	29.04	1	6	2.92
ASLG330	3.0 Liter/ 101 oz, 6 3/4" Diameter Base x 16 3/4" Overall Height	EACH	30.80	1	6	3.11
<b>Push Button</b>						
ASPG319	1.9 Liter/ 64 oz, 6 3/4" Diameter Base x 15 3/4" Overall Height	EACH	24.64	1	6	2.69
ASPG322	2.2 Liter/ 74 oz, 6 3/4" Diameter Base x 15 3/4" Overall Height	EACH	27.06	1	6	2.77
ASPG325	2.5 Liter/ 84 oz, 6 3/4" Diameter Base x 16 1/2" Overall Height	EACH	29.04	1	6	2.92
ASPG330	3.0 Liter/ 101 oz, 6 3/4" Diameter Base x 16 3/4" Overall Height	EACH	29.04	1	6	2.92



**STAINLESS STEEL LINER & EXTERIOR**



ASPS325  
ASPS330



3 ID Tags Included

ITEM	DESCRIPTION	U/M	WEIGHT GROSS lbs	INNER PACK	MASTER PACK	CU. FT.
<b>Lever Top</b>						
ASLS325	2.5 Liter/ 84 oz, 6 1/2" Diameter Base x 15 1/2" Overall Height	EACH	32.56	1	6	2.77
ASLS330	3.0 Liter/ 101 oz, 6 1/2" Diameter Base x 16 1/2" Overall Height	EACH	35.86	1	6	2.92
<b>Push Button</b>						
ASPS325	2.5 Liter/ 84 oz, 6 1/2" Diameter Base redredx 15 1/2" Overall Height	EACH	32.56	1	6	2.77
ASPS330	3.0 Liter/ 101 oz 6 1/2" Diameter Base x 16 1/2" Overall Height	EACH	35.86	1	6	2.92



**SWIRL DOUBLE WALL INSULATED BEVERAGE SERVER**



PLWS020BK  
PLWS042BK  
PLWS064BK



PLWS020WT  
PLWS042WT  
PLWS064WT

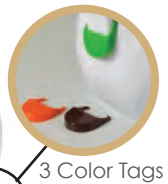

3 Color Tags

ITEM	DESCRIPTION	U/M	WEIGHT GROSS lbs	INNER PACK	MASTER PACK	CU. FT.
<b>Black</b>						
PLWS020BK	20 oz/0.6 Liter, Plastic, Black, 3¼" Diameter Base x 8½" Height with 4¾" Length x 7⁄8" Width Handle (2" Grip space)	SET	25.00	1	24	3.68
PLWS020BKL	Replacement Lid For PLWS020BK, 2¾" Diameter x 1¼" Height with 1" Push Button	EACH	3.53	1	24	0.30
PLWS042BK	42 oz/1.24 Liter, Plastic, Black, 4" Diameter Base x 9¾" Height with 7" Length x 1" Width Handle (2¾" Grip space)	SET	22.00	1	12	3.40
PLWS042BKL	Replacement Lid For PLWS042BK, 3½" Diameter x 2¼" Height with 1" Push Button	EACH	6.17	1	24	0.54
PLWS064BK	64 oz/1.9 Liter, Plastic, Black, 4¾" Diameter Base x 11¾" Height with 6" Length x 1" Width Handle (2½" Grip space)	SET	17.00	1	6	2.41
PLWS064BKL	Replacement Lid For PLWS064BK, 4¾" Diameter x 2½" Height with 1¼" Push Button	EACH	7.72	1	24	0.79
<b>White</b>						
PLWS020WT	20 oz/0.6 Liter, Plastic, White, 3¼" Diameter Base x 8½" Height with 4¾" Length x 7⁄8" Width Handle (2" Grip space)	SET	25.00	1	24	3.68
PLWS020WTL	Replacement Lid For PLWS020WT, 2¾" Diameter x 1¼" Height with 1" Push Button	EACH	3.53	1	24	0.30
PLWS042WT	42 oz/1.24 Liter, Plastic, White, 4" Diameter Base x 9¾" Height with 7" Length x 1" Width Handle (2¾" Grip space)	SET	22.00	1	12	3.40
PLWS042WTL	Replacement Lid For PLWS042WT, 3½" Diameter x 2¼" Height with 1" Push Button	EACH	6.17	1	24	0.54
PLWS064WT	64 oz/1.9 L, Plastic, White, 4¾" Diameter Base x 11¾" Height with 6" Length x 1" Width Handle (2½" Grip space)	SET	17.00	1	6	2.41
PLWS064WTL	Replacement Lid For PLWS064WT, 4¾" Diameter x 2½" Height with 1¼" Push Button	EACH	7.72	1	24	0.79

**COFFEE SERVER**

Coffee server keeps coffee hot and fresh for hours. Perfect for restaurants, hotels, or break rooms.



ASCS112  
ASCS115  
ASCS119



ASCS019BT



ASGD057

ITEM	DESCRIPTION	U/M	WEIGHT GROSS lbs	INNER PACK	MASTER PACK	CU. FT.
<b>Push Button, Stainless Steel Liner &amp; Exterior</b>						
ASCS112	1.2 L/40 oz, 5½" Diameter Base x 8¾" Height, 5½" Length x 1" Width Handle (1½" Grip) 1¾" Push Button, 1½" Spout	EACH	15.65	1	6	1.31
ASCS115	1.5 L/51 oz, 5½" Diameter Base x 9¾" Height, 5½" Length x 1" Width Handle (1½" Grip) 1¾" Push Button, 1½" Spout	EACH	16.75	1	6	1.47
ASCS119	1.9 L/64 oz, 5½" Diameter Base x 11½" Height, 5½" Length x 1" Width Handle (1½" Grip) 1¾" Push Button, 1½" Spout	EACH	20.94	1	6	1.68
<b>Bru-Thru Lid, Stainless Steel Liner &amp; Exterior</b>						
ASCS019BT	1.9 L/64 oz Coffee Server, S/S Push Button Top with Bru-Thru Lid, 6½" Diameter Base x 6¾" Height, 2¾" Length x 1" Width Handle (2" Grip) 1¾" Push Button, 1" Spout	EACH	18.30	1	6	1.72
ASGD057	5.7 L/1.5 Gallon Gravity Flow Dispenser, with Bru-Thru Lid, Removable Base 14" Base Length x 22½" Height (excluded Handle), 8½" Diameter Server (with 5" x 3½" Dispenser)	EACH	14.52	1	1	2.51



ALTBCR001G ALTBCR111A



ALDCS006

**TABLE CRUMBER**

Keeps unwanted morsels and crumbs off the table. Gold or silver colored aluminum scraper with pocket clip.



ITEM	DESCRIPTION	U/M	WEIGHT GROSS lbs	INNER PACK	MASTER PACK	CU. FT.
ALTBCR001G	Gold, 6" x 5/8" x 1/2"	EACH	10.14	120	600	0.36
ALTBCR111A	Silver, 6" x 5/8" x 1/2"	EACH	10.14	120	600	0.36
ALDCS006	5 1/2" x 1 1/8" x 1/2"	EACH	4.71	12	144	0.26

**SQUEEZE BOTTLE**

Great for dispensing liquids, sauces, and other toppings.



PLTHSB008C



PLTHSB008R PLTHSB008Y

ITEM	DESCRIPTION	U/M	WEIGHT GROSS lbs	INNER PACK	MASTER PACK	CU. FT.
<b>8 oz</b>						
PLTHSB008C	8 oz, Clear, 2" Diameter x 7" Height	DOZEN	5.28	6	6	1.18
PLTHSB008R	8 oz, Red, 2" Diameter x 7" Height	DOZEN	5.28	6	6	1.18
PLTHSB008Y	8 oz, Yellow, 2" Diameter x 7" Height	DOZEN	5.28	6	6	1.18
<b>12 oz</b>						
PLTHSB012C	12 oz, Clear, 2 1/8" Diameter x 7" Height	DOZEN	3.03	3	3	0.82
PLTHSB012R	12 oz, Red, 2 1/8" Diameter x 7" Height	DOZEN	3.03	3	3	0.82
PLTHSB012Y	12 oz, Yellow, 2 1/8" Diameter x 7" Height	DOZEN	3.03	3	3	0.82
<b>24 oz</b>						
PLTHSB024C	24 oz, Clear, 2 3/8" Diameter x 9 1/2" Height	DOZEN	5.38	3	3	1.50
PLTHSB024R	24 oz, Red, 2 3/8" Diameter x 9 1/2" Height	DOZEN	5.38	3	3	1.50
PLTHSB024Y	24 oz, Yellow, 2 3/8" Diameter x 9 1/2" Height	DOZEN	5.38	3	3	1.50

\*Sold by Master Pack Only

**SQUEEZE BOTTLE - WIDE MOUTH**

Wide mouth design for easy cleaning and refilling.



PLTHSB024CW

ITEM	DESCRIPTION	U/M	WEIGHT GROSS lbs	INNER PACK	MASTER PACK	CU. FT.
Pack of 6						
<b>16 oz</b>						
PLTHSB016CW	16 oz, Clear, 2 3/4" Diameter x 7 5/8" Height	PACK	14.00	1	12	3.25
PLTHSB016RW	16 oz, Red, 2 3/4" Diameter x 7 5/8" Height	PACK	14.00	1	12	3.25
PLTHSB016YW	16 oz, Yellow, 2 3/4" Diameter x 7 5/8" Height	PACK	14.00	1	12	3.25
<b>24 oz</b>						
PLTHSB024CW	24 oz, Clear, 2 3/4" Diameter x 9 3/8" Height	PACK	17.50	1	12	4.25
PLTHSB024RW	24 oz, Red, 2 3/4" Diameter x 9 3/8" Height	PACK	17.50	1	12	4.25
PLTHSB024YW	24 oz, Yellow, 2 3/4" Diameter x 9 3/8" Height	PACK	17.50	1	12	4.25
<b>32 oz</b>						
PLTHSB032CW	32 oz, Clear, 3 1/8" Diameter x 10 3/8" Height	PACK	17.60	1	12	5.73
PLTHSB032RW	32 oz, Red, 3 1/8" Diameter x 10 3/8" Height	PACK	17.60	1	12	5.73
PLTHSB032YW	32 oz, Yellow, 3 1/8" Diameter x 10 3/8" Height	PACK	17.60	1	12	5.73



### ACRYLIC PASTRY DISPLAY & TRAYS

Clear Acrylic cases with sloped front for easy viewing and selection. Hinged rear doors for easy access. Both trays and acrylic trays slide easily. Long-lasting and easy to clean.



ITEM	DESCRIPTION	U/M	WEIGHT GROSS lbs	INNER PACK	MASTER PACK	CU. FT.
PLDC001	21" x 17¼" x 16½" with 3 Trays (Tray size: 20¼" x 13¾" x ¾")	EACH	27.00	1	1	2.13
PLDC002	14" x 24" x 24" with 4 Trays	EACH	37.50	1	1	3.06
PLDCT001	Tray fits PLDC001 & PLDC002, 20¼" x 13¾" x ¾"	EACH	19.71	1	12	0.70

### FAST FOOD TRAY



Custom Colors Available  
Call for Quote  
(PLFFT only)



ITEM	DESCRIPTION	U/M	WEIGHT GROSS lbs	INNER PACK	MASTER PACK	CU. FT.
PLFFT1014BK	10½" x 13¾" x ¾", Black	EACH	30.14	12	48	1.67
PLFFT1014BR	10½" x 13¾" x ¾", Brown	EACH	30.14	12	48	1.67
PLFFT1014GR	10½" x 13¾" x ¾", Green	EACH	30.14	12	48	1.67
PLFFT1014RD	10½" x 13¾" x ¾", Red	EACH	30.14	12	48	1.67
PLFFT1014RR	10½" x 13¾" x ¾", Orange	EACH	30.14	12	48	1.67
PLFFT1216BK	12" x 16¼" x ¾", Black	EACH	39.40	12	48	2.39
PLFFT1216BR	12" x 16¼" x ¾", Brown	EACH	39.40	12	48	2.39
PLFFT1216GR	12" x 16¼" x ¾", Green	EACH	39.40	12	48	2.39
PLFFT1216RD	12" x 16¼" x ¾", Red	EACH	39.40	12	48	2.39
PLFFT1216RR	12" x 16¼" x ¾", Orange	EACH	39.40	12	48	2.39
PLFFT1418BK	14" x 17¾" x ¾", Black	EACH	28.57	12	24	1.53
PLFFT1418BR	14" x 17¾" x ¾", Brown	EACH	28.57	12	24	1.53
PLFFT1418GR	14" x 17¾" x ¾", Green	EACH	28.57	12	24	1.53
PLFFT1418RD	14" x 17¾" x ¾", Red	EACH	28.57	12	24	1.53
PLFFT1418RR	14" x 17¾" x ¾", Orange	EACH	28.57	12	24	1.53

## COMPARTMENT TRAY

Multi compartment trays are easy to hold.



SLCRT004



SLCST006

ITEM	DESCRIPTION	U/M	WEIGHT GROSS lbs	INNER PACK	MASTER PACK	CU. FT.
SLCRT004	12½" Diameter x 1" Thickness 4-Compartment	EACH	30.49	6	24	1.12
SLCST006	11⅜" x 15⅜" x 1" Thickness 6-Compartment	EACH	26.36	6	24	1.14

## MELAMINE



ML801S - Left Handed

ML802S - Right Handed



ML803T

ML803W



ITEM	DESCRIPTION	U/M	WEIGHT GROSS lbs	INNER PACK	MASTER PACK	CU. FT.
ML801S	14½" x 10" x 1½", Left Handed, Sand	DOZEN	29.85	0.50	2	1.47
ML802S	14½" x 10" x 1½", Right Handed, Sand	DOZEN	29.85	0.50	2	1.47
ML803T	13" x 9½" x 1", Tan	DOZEN	27.56	0.50	2	0.92
ML803W	13" x 9½" x 1", White	DOZEN	27.56	0.50	2	0.92

## MOLCAJETE SALSA BOWL

For hot or cold food items. Made of Polypropylene.



PLMJ004BK



PLMJ010BK



PLMJ056BK



Stackable



ITEM	DESCRIPTION	U/M	WEIGHT GROSS lbs	INNER PACK	MASTER PACK	Cu. Ft.
PLMJ004BK	4 oz, 4" Diameter x 1½" Height	PACK OF 4	17.20	1	24	1.22
PLMJ010BK	10 oz, 5⅝" Diameter x 2½" Height	PACK OF 4	19.84	1	12	1.54
PLMJ056BK	56 oz, 8⅝" Diameter x 4" Height	EACH	14.33	1	12	3.18



**WOVEN WOOD BOWL**

ITEM	DESCRIPTION	U/M	WEIGHT GROSS lbs	INNER PACK	MASTER PACK	CU. FT.
WDTSB006	6" Diameter x 1 1/2" Height	DOZEN	30.86	2	24	1.38
WDTSB008	8" Diameter x 2 1/4" Height	DOZEN	26.46	2	12	1.13
WDTSB010	10" Diameter x 2 1/2" Height	DOZEN	28.66	1	8	1.48
WDTSB012	12" Diameter x 2 3/4" Height	DOZEN	26.46	1	6	1.19
WDTSB014	14" Diameter x 3 1/2" Height	DOZEN	41.89	1	4	1.65
WDTSB016	16" Diameter x 4" Height	DOZEN	46.30	1	3	2.29
WDTSB018	18" Diameter x 4" Height	DOZEN	39.68	1	2	2.09
WDTSB020	20" Diameter x 4 1/2" Height	DOZEN	55.00	1	2	2.92



**TORTILLA WARMER**

Heavy duty polypropylene. Fits up to 8" tortillas. Also fits waffles, pancakes, rolls, toasts, and muffins; keeping them warm at the table.



ITEM	DESCRIPTION	U/M	WEIGHT GROSS lbs	INNER PACK	MASTER PACK	CU. FT.
PLTW085BK	8 1/2" Black, 8 1/2" Diameter x 2 3/8" Height, Lid: 1/2" x 8 1/2" Diameter, Knob: 3" Diameter	EACH	18.01	1	18	2.17
PLTW085BR	8 1/2" Terra Cotta, 8 1/2" Diameter x 2 3/8" Height, Lid: 1/2" x 8 1/2" Diameter, Knob: 3" Diameter	EACH	18.01	1	18	2.17



**TACO HOLDER**

Great for serving and/or displaying soft and hard shell tacos as well as hot dogs.

**Wire**

ITEM	DESCRIPTION	U/M	WEIGHT GROSS lbs	INNER PACK	MASTER PACK	CU. FT.
SLTR012W	1-2 Compartments, 3 5/8" x 2 1/2" x 1 1/2", with 1 1/8" Taco Holder Slot	EACH	31.04	12	144	0.46
SLTR023W	2-3 Compartments, 5 5/8" x 2 1/2" x 1 1/2", with 1 1/8" Taco Holder Slot	EACH	20.11	12	72	0.34
SLTR034W	3-4 Compartments, 7 3/8" x 2 1/2" x 1 1/2", with 1 1/8" Taco Holder Slot	EACH	16.67	12	48	0.30

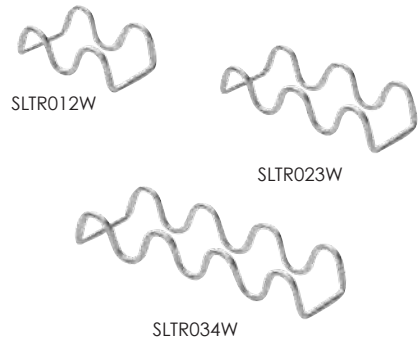

**Stainless Steel**

ITEM	DESCRIPTION	U/M	WEIGHT GROSS lbs	INNER PACK	MASTER PACK	CU. FT.
SLTR012F	1-2 Compartments, 5 1/2" x 4" x 2", Slot size: 2 3/4" x 2" x 1 1/8"	EACH	38.45	12	96	0.89
SLTR023F	2-3 Compartments, 8 3/8" x 4" x 2", Slot size: 2 3/4" x 2" x 1 1/8"	EACH	41.20	12	72	0.46
SLTR034F	3-4 Compartments, 11 1/8" x 4" x 2", Slot size: 2 3/4" x 2" x 1 1/8"	EACH	38.45	12	48	0.86
SLTR045F	4-5 Compartments, 13 3/8" x 4" x 2", Slot size: 2 3/4" x 2" x 1 1/8"	EACH	36.60	12	36	0.80

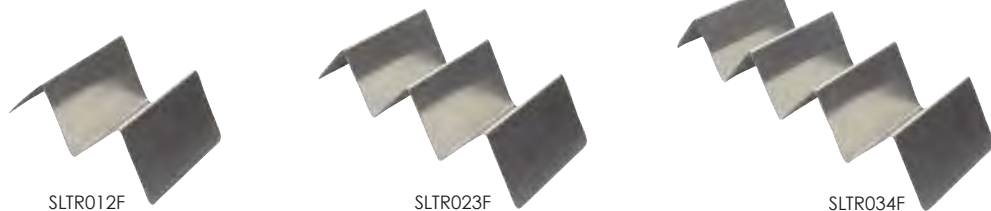
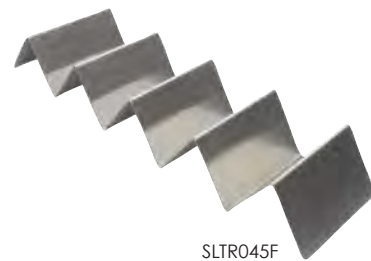

**BASKET**

Durable plastic basket woven to look like natural straw basket.



PLBB825



PLBB850



PLBB900



PLBB825G



PLBB850G



PLBB900G



PLBB1107



PLBB1209



ITEM	DESCRIPTION	U/M	WEIGHT GROSS lbs	INNER PACK	MASTER PACK	CU. FT.
PLBB825	8" Diameter x 2 1/4" Height, Round	EACH	24.20	12	144	2.74
PLBB850	8 1/4" x 4 1/4" x 2" Oblong	EACH	18.74	12	144	3.24
PLBB900	9 1/4" x 7" x 2 1/4" Oval	EACH	24.25	12	144	2.99
PLBB825G	8" Diameter x 2 1/4" Height, Round, Gold Trim	EACH	17.64	12	144	3.08
PLBB850G	8 1/4" x 4 1/4" x 2" Oblong, Gold Trim	EACH	15.43	12	144	2.36
PLBB900G	9 1/4" x 7" x 2 1/4" Oval, Gold Trim	EACH	18.74	12	144	2.38
PLBB1107	11" x 7" x 3 1/2" Oval	EACH	17.64	1	36	3.18
PLBB1209	12" x 9" x 3" Rectangular	EACH	23.59	1	36	4.64

**HANDWOVEN BASKET**

Made of high quality polypropylene. Straw mimicking natural materials make them durable and last much longer.



PLBN1208T



PLBN1313T



PLBN1813T

PLBN1410T

ITEM	DESCRIPTION	U/M	WEIGHT GROSS lbs	INNER PACK	MASTER PACK	CU. FT.
PLBN1208T	12" x 8" x 3" w/ Handle	EACH	16.98	1	36	3.15
PLBN1611T	16" x 11" x 3" w/ Handle	EACH	24.25	1	36	3.55
PLBN1712T	17" x 12 3/4" x 3" w/ Handle	EACH	33.51	1	36	7.81
PLBN1313T	13" x 13" x 4 1/2" Square	EACH	31.53	1	36	6.48
PLBN1410T	14" x 10" x 2" Rectangular	EACH	19.84	1	36	2.38
PLBN1813T	18" x 13" x 2" Rectangular	EACH	29.76	1	36	4.48



**BASKET - COLORED PLASTIC**

Durable polypropylene baskets with smooth bottom surface.



ITEM	DESCRIPTION	U/M	WEIGHT GROSS lbs	INNER PACK	MASTER PACK	CU. FT.
<b>Round</b>						
PLBK008B	8" Diameter x 2" Height, Brown	DOZEN	12.48	1	12	1.88
PLBK008G	8" Diameter x 2" Height, Green	DOZEN	12.48	1	12	1.88
PLBK008K	8" Diameter x 2" Height, Black	DOZEN	12.48	1	12	1.88
PLBK008R	8" Diameter x 2" Height, Red	DOZEN	12.48	1	12	1.88
PLBK008Y	8" Diameter x 2" Height, Yellow	DOZEN	12.48	1	12	1.88
<b>Oblong</b>						
PLBK1034B	10¾" x 7" x 1½", Brown	DOZEN	22.82	1	12	2.44
PLBK1034G	10¾" x 7" x 1½", Green	DOZEN	22.82	1	12	2.44
PLBK1034K	10¾" x 7" x 1½", Black	DOZEN	22.82	1	12	2.44
PLBK1034R	10¾" x 7" x 1½", Red	DOZEN	22.82	1	12	2.44
PLBK1034Y	10¾" x 7" x 1½", Yellow	DOZEN	22.82	1	12	2.44
<b>Oval</b>						
PLBK938B	9¾" x 5½" x 1¾", Brown	DOZEN	10.52	1	12	1.52
PLBK938G	9¾" x 5½" x 1¾", Green	DOZEN	10.52	1	12	1.52
PLBK938K	9¾" x 5½" x 1¾", Black	DOZEN	10.52	1	12	1.52
PLBK938R	9¾" x 5½" x 1¾", Red	DOZEN	10.52	1	12	1.52
PLBK938Y	9¾" x 5½" x 1¾", Yellow	DOZEN	10.52	1	12	1.52
PLBK912G	7¾" x 4¾" x 2¾", Green	DOZEN	13.00	1	12	1.20

**PLASTIC SWIRL DESSERT DISH**

Add to the pleasure of indulging in ice cream, candies or mints with these tulip shaped bowls. Stackable and durable plastic.



ITEM	DESCRIPTION	U/M	WEIGHT GROSS lbs	INNER PACK	MASTER PACK	CU. FT.
PLDS005C	5 oz, Clear, 3¾" Diameter x 2½" Height	DOZEN	11.90	1	8	0.72
PLDS005B	5 oz, Blue, 3¾" Diameter x 2½" Height	DOZEN	11.90	1	8	0.72
PLDS005K	5 oz, Black, 3¾" Diameter x 2½" Height	DOZEN	11.90	1	8	0.72
PLDS005P	5 oz, Purple, 3¾" Diameter x 2½" Height	DOZEN	11.90	1	8	0.72

BELIZE® TUMBLER

Unique Swirl Design presents a perfect glass-like table top tumbler presentation.



**Starburst® Design**  
Minimizes skidding on wet surfaces while allowing residual water to drain away when placed in an inverted position for stacking and storing.



10 oz

- Sizes:
- Blue
  - Clear
  - Red
  - Green

- 8 oz**
- 10 oz**
- 12 oz**
- 14 oz**
- 16 oz**
- 20 oz**
- 24 oz**

ITEM	DESCRIPTION	Rim-Full CAPACITY	U/M	WEIGHT GROSS lbs	INNER PACK	MASTER PACK	CU. FT.
<b>8 oz</b>							
PLPCTB308BL	8 oz Blue, 2 $\frac{5}{8}$ " Diameter x 4 $\frac{3}{8}$ " Height	8 oz	DOZEN	9.55	1	4	1.18
PLPCTB308CL	8 oz Clear, 2 $\frac{5}{8}$ " Diameter x 4 $\frac{3}{8}$ " Height	8 oz	DOZEN	9.55	1	4	1.18
PLPCTB308GR	8 oz Green, 2 $\frac{5}{8}$ " Diameter x 4 $\frac{3}{8}$ " Height	8 oz	DOZEN	9.55	1	4	1.18
PLPCTB308RD	8 oz Red, 2 $\frac{5}{8}$ " Diameter x 4 $\frac{3}{8}$ " Height	8 oz	DOZEN	9.55	1	4	1.18
<b>10 oz</b>							
PLPCTB310BL	10 oz Blue, 3" Diameter x 5" Height	12 oz	DOZEN	11.71	1	4	0.83
PLPCTB310CL	10 oz Clear, 3" Diameter x 5" Height	12 oz	DOZEN	11.71	1	4	0.83
PLPCTB310GR	10 oz Green, 3" Diameter x 5" Height	12 oz	DOZEN	11.71	1	4	0.83
PLPCTB310RD	10 oz Red, 3" Diameter x 5" Height	12 oz	DOZEN	11.71	1	4	0.83
<b>12 oz</b>							
PLPCTB312BL	12 oz Blue, 3 $\frac{1}{8}$ " Diameter x 5 $\frac{3}{8}$ " Height	14 oz	DOZEN	12.99	1	4	0.86
PLPCTB312CL	12 oz Clear, 3 $\frac{1}{8}$ " Diameter x 5 $\frac{3}{8}$ " Height	14 oz	DOZEN	12.99	1	4	0.86
PLPCTB312GR	12 oz Green, 3 $\frac{1}{8}$ " Diameter x 5 $\frac{3}{8}$ " Height	14 oz	DOZEN	12.99	1	4	0.86
PLPCTB312RD	12 oz Red, 3 $\frac{1}{8}$ " Diameter x 5 $\frac{3}{8}$ " Height	14 oz	DOZEN	12.99	1	4	0.86
<b>14 oz</b>							
PLPCTB314BL	14 oz Blue, 3 $\frac{1}{8}$ " Diameter x 5 $\frac{7}{8}$ " Height	16 oz	DOZEN	14.24	1	4	1.00
PLPCTB314CL	14 oz Clear, 3 $\frac{1}{8}$ " Diameter x 5 $\frac{7}{8}$ " Height	16 oz	DOZEN	14.24	1	4	1.00
PLPCTB314GR	14 oz Green, 3 $\frac{1}{8}$ " Diameter x 5 $\frac{7}{8}$ " Height	16 oz	DOZEN	14.24	1	4	1.00
PLPCTB314RD	14 oz Red, 3 $\frac{1}{8}$ " Diameter x 5 $\frac{7}{8}$ " Height	16 oz	DOZEN	14.24	1	4	1.00
<b>16 oz</b>							
PLPCTB316BL	16 oz Blue, 3 $\frac{1}{2}$ " Diameter x 6 $\frac{1}{8}$ " Height	18 oz	DOZEN	15.61	1	4	1.07
PLPCTB316CL	16 oz Clear, 3 $\frac{1}{2}$ " Diameter x 6 $\frac{1}{8}$ " Height	18 oz	DOZEN	15.61	1	4	1.07
PLPCTB316GR	16 oz Green, 3 $\frac{1}{2}$ " Diameter x 6 $\frac{1}{8}$ " Height	18 oz	DOZEN	15.61	1	4	1.07
PLPCTB316RD	16 oz Red, 3 $\frac{1}{2}$ " Diameter x 6 $\frac{1}{8}$ " Height	18 oz	DOZEN	15.61	1	4	1.07
<b>20 oz</b>							
PLPCTB320BL	20 oz Blue, 3 $\frac{1}{2}$ " Diameter x 6 $\frac{1}{2}$ " Height	22 oz	DOZEN	15.29	1	4	1.20
PLPCTB320CL	20 oz Clear, 3 $\frac{1}{2}$ " Diameter x 6 $\frac{1}{2}$ " Height	22 oz	DOZEN	15.29	1	4	1.20
PLPCTB320GR	20 oz Green, 3 $\frac{1}{2}$ " Diameter x 6 $\frac{1}{2}$ " Height	22 oz	DOZEN	15.29	1	4	1.20
PLPCTB320RD	20 oz Red, 3 $\frac{1}{2}$ " Diameter x 6 $\frac{1}{2}$ " Height	22 oz	DOZEN	15.29	1	4	1.20
<b>24 oz</b>							
PLPCTB324BL	24 oz Blue, 3 $\frac{5}{8}$ " Diameter x 6 $\frac{7}{8}$ " Height	26 oz	DOZEN	19.78	1	4	1.45
PLPCTB324CL	24 oz Clear, 3 $\frac{5}{8}$ " Diameter x 6 $\frac{7}{8}$ " Height	26 oz	DOZEN	19.78	1	4	1.45
PLPCTB324GR	24 oz Green, 3 $\frac{5}{8}$ " Diameter x 6 $\frac{7}{8}$ " Height	26 oz	DOZEN	19.78	1	4	1.45
PLPCTB324RD	24 oz Red, 3 $\frac{5}{8}$ " Diameter x 6 $\frac{7}{8}$ " Height	26 oz	DOZEN	19.78	1	4	1.45

## DIAMOND TUMBLER

These tumblers are scratch resistant, crystal glass-like and virtually Unbreakable.

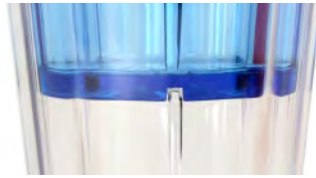

All Diamond tumblers feature stackable Anti-Jam locking tabs



ITEM	DESCRIPTION	Rim-Full CAPACITY	U/M	WEIGHT GROSS lbs	INNER PACK	MASTER PACK	CU. FT.
<b>8 oz</b>							
PLPCTB108CL	8 oz Clear, 3 1/8" Diameter x 3 1/4" Height	8 oz	DOZEN	8.43	1	4	0.87
PLPCTB108BL	8 oz Blue, 3 1/8" Diameter x 3 1/4" Height	8 oz	DOZEN	8.43	1	4	0.87
PLPCTB108GR	8 oz Green, 3 1/8" Diameter x 3 1/4" Height	8 oz	DOZEN	8.43	1	4	0.87
PLPCTB108RD	8 oz Red, 3 1/8" Diameter x 3 1/4" Height	8 oz	DOZEN	8.43	1	4	0.87
<b>10 oz</b>							
PLPCTB110CL	10 oz Clear, 3" Diameter x 4 3/4" Height	12 oz	DOZEN	11.24	1	4	0.87
PLPCTB110BL	10 oz Blue, 3" Diameter x 4 3/4" Height	12 oz	DOZEN	11.24	1	4	0.87
PLPCTB110GR	10 oz Green, 3" Diameter x 4 3/4" Height	12 oz	DOZEN	11.24	1	4	0.87
PLPCTB110RD	10 oz Red, 3" Diameter x 4 3/4" Height	12 oz	DOZEN	11.24	1	4	0.87
<b>12 oz</b>							
PLPCTB112CL	12 oz Clear, 3 1/8" Diameter x 5 1/8" Height	14 oz	DOZEN	12.06	1	4	0.98
PLPCTB112BL	12 oz Blue, 3 1/8" Diameter x 5 1/8" Height	14 oz	DOZEN	12.06	1	4	0.98
PLPCTB112GR	12 oz Green, 3 1/8" Diameter x 5 1/8" Height	14 oz	DOZEN	12.06	1	4	0.98
PLPCTB112RD	12 oz Red, 3 1/8" Diameter x 5 1/8" Height	14 oz	DOZEN	12.06	1	4	0.98
<b>14 oz</b>							
PLPCTB114CL	14 oz Clear, 3 1/4" Diameter x 5 1/8" Height	16 oz	DOZEN	13.56	1	4	1.21
PLPCTB114BL	14 oz Blue, 3 1/4" Diameter x 5 1/8" Height	16 oz	DOZEN	13.56	1	4	1.21
PLPCTB114GR	14 oz Green, 3 1/4" Diameter x 5 1/8" Height	16 oz	DOZEN	13.56	1	4	1.21
PLPCTB114RD	14 oz Red, 3 1/4" Diameter x 5 1/8" Height	16 oz	DOZEN	13.56	1	4	1.21
<b>16 oz</b>							
PLPCTB116CL	16 oz Clear, 3 1/2" Diameter x 5 7/8" Height	18 oz	DOZEN	14.77	1	4	1.26
PLPCTB116BL	16 oz Blue, 3 1/2" Diameter x 5 7/8" Height	18 oz	DOZEN	14.77	1	4	1.26
PLPCTB116GR	16 oz Green, 3 1/2" Diameter x 5 7/8" Height	18 oz	DOZEN	14.77	1	4	1.26
PLPCTB116RD	16 oz Red, 3 1/2" Diameter x 5 7/8" Height	18 oz	DOZEN	14.77	1	4	1.26
<b>20 oz</b>							
PLPCTB120CL	20 oz Clear, 3 5/8" Diameter x 6" Height	22 oz	DOZEN	18.92	1	4	1.87
PLPCTB120BL	20 oz Blue, 3 5/8" Diameter x 6" Height	22 oz	DOZEN	18.92	1	4	1.87
PLPCTB120GR	20 oz Green, 3 5/8" Diameter x 6" Height	22 oz	DOZEN	18.92	1	4	1.87
PLPCTB120RD	20 oz Red, 3 5/8" Diameter x 6" Height	22 oz	DOZEN	18.92	1	4	1.87
<b>24 oz</b>							
PLPCTB124CL	24 oz Clear, 3 5/8" Diameter x 6 5/8" Height	26 oz	DOZEN	21.01	1	4	2.30
PLPCTB124BL	24 oz Blue, 3 5/8" Diameter x 6 5/8" Height	26 oz	DOZEN	21.01	1	4	2.30
PLPCTB124GR	24 oz Green, 3 5/8" Diameter x 6 5/8" Height	26 oz	DOZEN	21.01	1	4	2.30
PLPCTB124RD	24 oz Red, 3 5/8" Diameter x 6 5/8" Height	26 oz	DOZEN	21.01	1	4	2.30



8 oz (Rock Glass)



14 oz

Sizes:

- Blue **8 oz**
- Clear **12 oz**
- Red **16 oz**
- Green **20 oz**
- Green **24 oz**



9 1/2 oz Red



12 oz Clear



16 oz Amber



20 oz Blue



PLPTB016A

PLPTB016C

**TUMBLER**

Textured exterior resists scratching and plastic is impact resistant. Stackable and dishwasher safe. 176° F max temperature.



ITEM	DESCRIPTION	U/M	WEIGHT GROSS lbs	INNER PACK	MASTER PACK	CU. FT.
<b>5 oz</b>						
PLTHTB005A	5 oz Amber, 2 3/8" Diameter x 3 5/8" Height	DOZEN	6.39	1	6	0.62
PLTHTB005B	5 oz Blue, 2 3/8" Diameter x 3 5/8" Height	DOZEN	6.39	1	6	0.62
PLTHTB005C	5 oz Clear, 2 3/8" Diameter x 3 5/8" Height	DOZEN	6.39	1	6	0.62
PLTHTB005R	5 oz Red, 2 3/8" Diameter x 3 5/8" Height	DOZEN	6.39	1	6	0.62
<b>8 oz</b>						
PLTHTB008A	8 oz Amber, 2 5/8" Diameter x 4" Height	DOZEN	8.09	1	6	0.77
PLTHTB008B	8 oz Blue, 2 5/8" Diameter x 4" Height	DOZEN	8.09	1	6	0.77
PLTHTB008C	8 oz Clear, 2 5/8" Diameter x 4" Height	DOZEN	8.09	1	6	0.77
PLTHTB008R	8 oz Red, 2 5/8" Diameter x 4" Height	DOZEN	8.09	1	6	0.77
<b>9 1/2 oz</b>						
PLTHTB010A	9 1/2 oz Amber, 2 3/4" Diameter x 4 1/2" Height	DOZEN	7.89	1	6	0.85
PLTHTB010B	9 1/2 oz Blue, 2 3/4" Diameter x 4 1/2" Height	DOZEN	7.89	1	6	0.85
PLTHTB010C	9 1/2 oz Clear, 2 3/4" Diameter x 4 1/2" Height	DOZEN	7.89	1	6	0.85
PLTHTB010R	9 1/2 oz Red, 2 3/4" Diameter x 4 1/2" Height	DOZEN	7.89	1	6	0.85
<b>12 oz</b>						
PLTHTB012A	12 oz Amber, 3" Diameter x 5" Height	DOZEN	10.56	1	6	1.03
PLTHTB012B	12 oz Blue, 3" Diameter x 5" Height	DOZEN	10.56	1	6	1.03
PLTHTB012C	12 oz Clear, 3" Diameter x 5" Height	DOZEN	10.56	1	6	1.03
PLTHTB012R	12 oz Red, 3" Diameter x 5" Height	DOZEN	10.56	1	6	1.03
<b>16 oz</b>						
PLTHTB016A	16 oz Amber, 3 1/8" Diameter x 5 5/8" Height	DOZEN	14.79	1	6	1.26
PLTHTB016B	16 oz Blue, 3 1/8" Diameter x 5 5/8" Height	DOZEN	14.79	1	6	1.26
PLTHTB016C	16 oz Clear, 3 1/8" Diameter x 5 5/8" Height	DOZEN	14.79	1	6	1.26
PLTHTB016R	16 oz Red, 3 1/8" Diameter x 5 5/8" Height	DOZEN	14.79	1	6	1.26
<b>20 oz</b>						
PLTHTB020A	20 oz Amber, 3 3/4" Diameter x 6 1/2" Height	DOZEN	20.33	1	6	1.73
PLTHTB020B	20 oz Blue, 3 3/4" Diameter x 6 1/2" Height	DOZEN	20.33	1	6	1.73
PLTHTB020C	20 oz Clear, 3 3/4" Diameter x 6 1/2" Height	DOZEN	20.33	1	6	1.73
PLTHTB020R	20 oz Red, 3 3/4" Diameter x 6 1/2" Height	DOZEN	20.33	1	6	1.73
<b>24 oz</b>						
PLTHTB024A	24 oz Amber, 3 3/4" Diameter x 7" Height	DOZEN	17.28	1	6	1.60
PLTHTB024B	24 oz Blue, 3 3/4" Diameter x 7" Height	DOZEN	17.28	1	6	1.60
PLTHTB024C	24 oz Clear, 3 3/4" Diameter x 7" Height	DOZEN	17.28	1	6	1.60
PLTHTB024R	24 oz Red, 3 3/4" Diameter x 7" Height	DOZEN	17.28	1	6	1.60
<b>32 oz</b>						
PLTHTB032A	32 oz Amber, 4 1/8" Diameter x 6 5/8" Height	DOZEN	8.40	1	2	1.01
PLTHTB032B	32 oz Blue, 4 1/8" Diameter x 6 5/8" Height	DOZEN	8.40	1	2	1.01
PLTHTB032C	32 oz Clear, 4 1/8" Diameter x 6 5/8" Height	DOZEN	8.40	1	2	1.01
PLTHTB032R	32 oz Red, 4 1/8" Diameter x 6 5/8" Height	DOZEN	8.40	1	2	1.01
PLTHTB032TA	32 oz Amber Tall, 4" Diameter x 7 1/4" Height	DOZEN	7.39	1	2	0.99
PLTHTB032TB	32 oz Blue Tall, 4" Diameter x 7 1/4" Height	DOZEN	7.39	1	2	0.99
PLTHTB032TC	32 oz Clear Tall, 4" Diameter x 7 1/4" Height	DOZEN	7.39	1	2	0.99
PLTHTB032TR	32 oz Red Tall, 4" Diameter x 7 1/4" Height	DOZEN	7.39	1	2	0.99
<b>16 oz Pebble Tumbler</b>						
PLPTB016A	16 oz, Amber, 3" Diameter x 5 5/8" Height	DOZEN	17.20	1	6	2.50
PLPTB016C	16 oz, Clear, 3" Diameter x 5 5/8" Height	DOZEN	17.20	1	6	2.50

**STEAK AND BREAD KNIFE**

A wide selection of stainless steel bread knives and steak knives with sharp serrated edges.



SLSK008 SLSK016 SLSK017 SLSK GK001 SLBK013 SLSK108 SLSK116 SLSK117 SLSK GK002

ITEM	DESCRIPTION	U/M	WEIGHT GROSS lbs	INNER PACK	MASTER PACK	CU. FT.
<b>Wood Handle</b>						
SLSK008	4½" Blade Pointed Tip Steak Knife, 8¾" x ½"	DOZEN	35.27	2	40	0.77
SLSK016	4" Blade Round Tip Steak Knife, 8¼" x ⅝"	DOZEN	35.27	2	40	0.77
SLSK017	4¼" Blade Wood Handle, 8⅝" x ½"	DOZEN	35.20	2	50	0.70
SLSK GK001	5" Blade Round Tip Jumbo Knife, 9⅞" x 1"	DOZEN	37.08	1	15	0.84
SLBK013	8½" Blade Bread Knife, 13½" x 1⅞"	DOZEN	36.16	1	10	0.77
<b>Plastic Handle</b>						
SLSK108	4¾" Blade Pointed Tip Steak Knife, 8⅝" x ¾"	DOZEN	33.00	2	40	0.93
SLSK116	5" Blade Round Tip Steak Knife, 8⅝" x ¾"	DOZEN	35.27	2	40	0.93
SLSK117	4¼" Blade, Plastic Handle, 7⅞" x ½"	DOZEN	24.30	2	50	0.54
SLSK GK002	5" Blade Round Tip Jumbo Knife, 10" x 1¼"	DOZEN	37.08	1	15	0.72

**FAJITA BOARD AND CAST IRON SKILLET**

¾" thick wooden fajita board with side grooves to catch sauce or grease. Easy to clean and can be stacked when stored.



IRSK795

WDFJ001

ITEM	DESCRIPTION	U/M	WEIGHT GROSS lbs	INNER PACK	MASTER PACK	CU. FT.
WDFJ001	Fajita Board, 12¼" x 8" x ¾"	EACH	11.68	12	12	0.49
IRSK795	7" x 9¼" Cast Iron Skillet	EACH	38.03	1	12	1.61

### GRIDDLE SET

This 3-piece griddle set includes cast-iron griddle, gripper, and wood underliner. Safely handle hot griddles with the sturdy grippers and placed them over the wood underliner.

ITEM	DESCRIPTION	U/M	WEIGHT GROSS lbs	INNER PACK	MASTER PACK	CU. FT.
IRBB001	Pork Board, Gripper: 5" x 1½" x 1" / Griddle: 10½" x 6¾" x 1" / Wooden Board: 12½" x 7⅞" x ⅝"	EACH	39.70	10	10	1.29
IRBB002	Steak Board, Gripper: 6" x 1½" x ½" / Griddle: 8½" x 5⅞" x ⅞" / Wooden Board: 14¾" x 8¼" x ⅝"	EACH	66.10	10	10	1.63

\*Sold by Master Pack Only

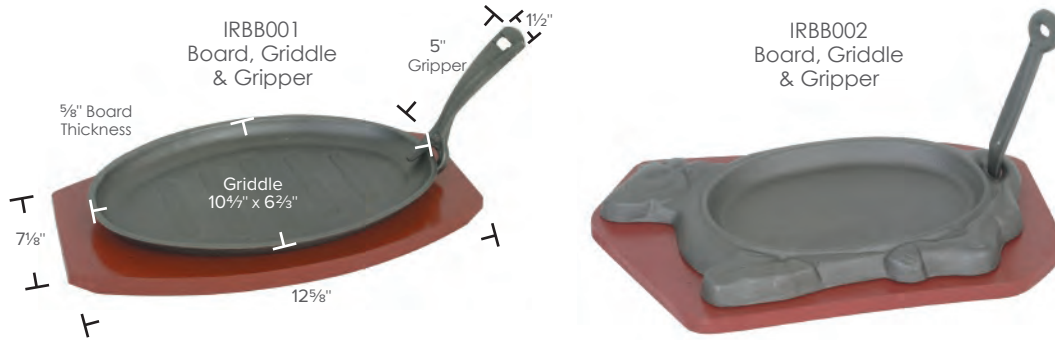

### SIZZLING PLATTER

Stainless steel platter offers elegant presentation with accommodating thermal Sizzling platter (sold separately).



ITEM	DESCRIPTION	U/M	WEIGHT GROSS lbs	INNER PACK	MASTER PACK	CU. FT.
IRSP1107	11" x 7⅞" x ½" Rectangular	EACH	49.20	12	60	3.18
IRSP1108	11⅞" x 8" x ⅝" Oval	EACH	52.00	12	60	4.24



IRSP1107



IRSP1108

### BAKELITE UNDERLINER

Black thermal platter offers elegant presentation.

ITEM	DESCRIPTION	U/M	WEIGHT GROSS lbs	INNER PACK	MASTER PACK	CU. FT.
WDSP1107	Fits IRSP1107, Rectangular 13" x 8" x 1"	EACH	59.50	12	60	2.52
WDSP1108	Fits IRSP1108, Oval 13⅞" x 8⅞" x 1"	EACH	70.50	12	60	4.87



WDSP1107



WDSP1108



**ESCARGOT TRAY, TONG & FORK**

A number of special items are needed to properly serve escargot, including a plate, tong and a fork. Snail plate has six slight depressions in which the escargot shells sit in order to keep them from rolling across the plate.



ITEM	DESCRIPTION	U/M	WEIGHT GROSS lbs	INNER PACK	MASTER PACK	CU. FT.
SLSN006D	Dish, 6 Holes, 7½" x 5½" x ⅝"	EACH	34.50	12	144	0.70
SLSN006T	Squeeze Tong, 6½" x 1½" x 1"	EACH	43.83	24	600	2.04
SLSN006F	Fork, 6" x ⅝" x 1"	DOZEN	24.69	1	50	0.25



SLSN006D



SLSN006T



SLSN006F

**GRAPEFRUIT SPOON w/SERRATED EDGE**

A durable mirror finished spoon with serrated edges to easily scoop out the grapefruit.



ITEM	DESCRIPTION	U/M	WEIGHT GROSS lbs	INNER PACK	MASTER PACK	CU. FT.
SLGF004	Spoon with Serrated Edge 6¾" x 1½" x ¼"	DOZEN	26.46	1	36	0.30

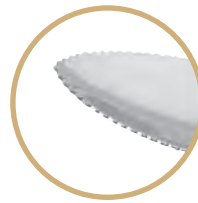

SLGF004

**LOBSTER CRACKER**

Jagged ridges can crack small or large claws. Wide swing handles.

ITEM	DESCRIPTION	U/M	WEIGHT GROSS lbs	INNER PACK	MASTER PACK	CU. FT.
SLLC006A	6" x 1¼" x ⅜" Zinc Alloy	EACH	40.79	24	144	1.45
SLLC006B	6" x 1½" x ⅜" Cast Steel	EACH	57.11	12	144	0.76
SLLC116W	6" x 1½" x ½" Wood Handle	EACH	34.10	12	144	1.62



SLLC006A



SLLC006A



SLLC006B



SLLC116W

**CLAM KNIFE**

ITEM	DESCRIPTION	U/M	WEIGHT GROSS lbs	INNER PACK	MASTER PACK	CU. FT.
SLTWCK007	7¼" x ⅞" x ½" Clam Knife	EACH	30.20	12	240	0.57



SLTWCK007



## ATLANTIC

ITEM	DESCRIPTION	U/M	WEIGHT GROSS lbs	INNER PACK	MASTER PACK	CU. FT.
SLAT201	Demitasse Spoon	DOZEN	12.10	1	25	0.23
SLAT202	Teaspoon	DOZEN	23.76	1	25	0.40
SLAT203	Bouillon Spoon	DOZEN	26.40	1	25	0.54
SLAT204	Dinner Spoon	DOZEN	38.06	1	25	0.61
SLAT205	Iced Tea Spoon	DOZEN	22.88	1	25	0.54
SLAT206	Dinner Fork	DOZEN	32.78	1	25	0.50
SLAT207	Salad Fork	DOZEN	22.88	1	25	0.56
SLAT209	Dinner Knife	DOZEN	40.48	1	15	0.50
SLAT210	Table Spoon (European Size)	DOZEN	45.10	1	25	0.84
SLAT211	Butter Knife	DOZEN	22.22	1	25	0.44
SLAT212	Table Fork (European Size)	DOZEN	36.52	1	25	0.69
SLAT215	Hollow Handle Table Knife	DOZEN	35.86	1	15	0.68
SLAT216	Steak Knife	DOZEN	33.00	1	15	0.41
SLAT218	Table Knife (European Size)	DOZEN	44.44	1	15	0.52
SLAT219	Salad Knife	DOZEN	33.66	1	15	0.38

18/10 **SS** STAINLESS STEEL



## DIAMOND

ITEM	DESCRIPTION	U/M	WEIGHT GROSS lbs	INNER PACK	MASTER PACK	CU. FT.
SLDM201	Demitasse Spoon	DOZEN	10.12	1	25	0.23
SLDM202	Teaspoon	DOZEN	22.44	1	25	0.40
SLDM203	Bouillon Spoon	DOZEN	23.54	1	25	0.54
SLDM204	Dinner Spoon	DOZEN	34.76	1	25	0.61
SLDM205	Iced Tea Spoon	DOZEN	22.22	1	25	0.54
SLDM206	Dinner Fork	DOZEN	26.84	1	25	0.50
SLDM207	Salad Fork	DOZEN	17.82	1	25	0.40
SLDM208	Oyster Fork	DOZEN	13.64	1	25	0.26
SLDM209	Dinner Knife	DOZEN	37.62	1	15	0.50
SLDM210	Table Spoon (European Size)	DOZEN	48.40	1	25	0.84
SLDM211	Butter Knife	DOZEN	16.72	1	25	0.44
SLDM212	Table Fork (European Size)	DOZEN	41.80	1	25	0.69
SLDM215	Hollow Handle Dinner Knife	DOZEN	29.70	1	15	0.68
SLDM218	Hollow Handle Table Knife	DOZEN	36.96	1	15	0.68

18/10  STAINLESS  
STEEL



## ELIZABETH

ITEM	DESCRIPTION	U/M	WEIGHT GROSS lbs	INNER PACK	MASTER PACK	CU. FT.
SLEL201	Demitasse Spoon	DOZEN	10.78	1	25	0.23
SLEL202	Teaspoon	DOZEN	25.08	1	25	0.40
SLEL203	Bouillon Spoon	DOZEN	25.08	1	25	0.54
SLEL204	Dinner Spoon	DOZEN	39.60	1	25	0.61
SLEL205	Iced Tea Spoon	DOZEN	20.46	1	25	0.54
SLEL206	Dinner Fork	DOZEN	34.98	1	25	0.50
SLEL207	Salad Fork	DOZEN	23.54	1	25	0.56
SLEL208	Oyster Fork	DOZEN	15.62	1	25	0.26
SLEL209	Dinner Knife	DOZEN	38.28	1	15	0.41
SLEL210	Table Spoon (European Size)	DOZEN	48.40	1	25	0.84
SLEL211	Butter Knife	DOZEN	20.24	1	25	0.44
SLEL212	Table Fork (European Size)	DOZEN	41.14	1	25	0.69
SLEL218	Table Knife (European Size)	DOZEN	48.84	1	15	0.52

18/10  STAINLESS  
STEEL



## SIMPLICITY

ITEM	DESCRIPTION	U/M	WEIGHT GROSS lbs	INNER PACK	MASTER PACK	CU. FT.
SLSM202	Teaspoon	DOZEN	25.08	1	25	0.40
SLSM203	Bouillon Spoon	DOZEN	26.40	1	25	0.54
SLSM204	Dinner Spoon	DOZEN	44.00	1	25	0.61
SLSM205	Iced Tea Spoon	DOZEN	26.18	1	25	0.54
SLSM206	Dinner Fork	DOZEN	38.06	1	25	0.50
SLSM207	Salad Fork	DOZEN	26.18	1	25	0.26
SLSM208	Oyster Fork	DOZEN	17.82	1	25	0.56
SLSM209	Dinner Knife	DOZEN	43.78	1	15	0.52
SLSM210	Table Spoon	DOZEN	51.04	1	25	0.84
SLSM211	Butter Knife	DOZEN	21.34	1	25	0.44
SLSM212	Table Fork	DOZEN	41.80	1	25	0.69

18/10  STAINLESS  
STEEL



## WILSHIRE

ITEM	DESCRIPTION	U/M	WEIGHT GROSS lbs	INNER PACK	MASTER PACK	CU. FT.
SLWH201	Demitasse Spoon	DOZEN	10.78	1	25	0.23
SLWH202	Teaspoon	DOZEN	23.10	1	25	0.40
SLWH203	Bouillon Spoon	DOZEN	25.08	1	25	0.54
SLWH204	Dinner Spoon	DOZEN	38.94	1	25	0.61
SLWH205	Iced Tea Spoon	DOZEN	22.44	1	25	0.54
SLWH206	Dinner Fork	DOZEN	33.00	1	25	0.50
SLWH207	Salad Fork	DOZEN	24.86	1	25	0.56
SLWH208	Oyster Fork	DOZEN	14.96	1	25	0.26
SLWH209	Dinner Knife	DOZEN	39.82	1	15	0.52
SLWH210	Table Spoon (European Size)	DOZEN	50.38	1	25	0.84
SLWH211	Butter Knife	DOZEN	22.88	1	25	0.44
SLWH212	Table Fork (European Size)	DOZEN	38.50	1	25	0.69
SLWH216	Salad Knife	DOZEN	52.80	1	25	0.38

18/10  STAINLESS STEEL



## YORK

ITEM	DESCRIPTION	U/M	WEIGHT GROSS lbs	INNER PACK	MASTER PACK	CU. FT.
SLYK201	Demitasse Spoon	DOZEN	12.10	1	25	0.23
SLYK202	Teaspoon	DOZEN	25.08	1	25	0.40
SLYK203	Bouillon Spoon	DOZEN	26.40	1	25	0.54
SLYK204	Dinner Spoon	DOZEN	42.02	1	25	0.61
SLYK205	Iced Tea Spoon	DOZEN	23.10	1	25	0.54
SLYK206	Dinner Fork	DOZEN	33.00	1	25	0.50
SLYK207	Salad Fork	DOZEN	22.22	1	25	0.56
SLYK208	Oyster Fork	DOZEN	14.96	1	25	0.26
SLYK209	Dinner Knife	DOZEN	39.82	1	15	0.52
SLYK210	Table Spoon	DOZEN	49.72	1	25	0.84
SLYK211	Butter Knife	DOZEN	22.22	1	25	0.44
SLYK212	Table Fork	DOZEN	39.82	1	25	0.69

18/10  STAINLESS  
STEEL



### DAKOTA SATIN

A durable finished, stainless steel flatware set, serves sweets or a full course meal with simple line-trimmed handle.

ITEM	DESCRIPTION	U/M	WEIGHT GROSS lbs	INNER PACK	MASTER PACK	CU. FT.
SLDK102	Teaspoon	DOZEN	36.40	1	50	0.45
SLDK103	Bouillon Spoon	DOZEN	40.40	1	50	0.58
SLDK104	Dessert Spoon	DOZEN	51.00	1	50	0.82
SLDK105	Iced Tea Spoon	DOZEN	40.40	1	50	0.34
SLDK106F	Dinner Fork 4 Tines	DOZEN	45.60	1	50	0.55
SLDK106	Dinner Fork	DOZEN	43.10	1	50	0.39
SLDK107	Salad Fork	DOZEN	32.40	1	50	0.40
SLDK108	Oyster Fork	DOZEN	28.50	1	50	0.28
SLDK109	Dinner Knife	DOZEN	56.60	1	25	0.35



STAINLESS STEEL



↓ 2.0 mm to  
↑ 2.2 mm Thickness

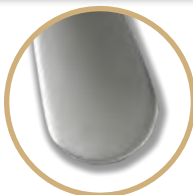

### TAHOE

A durable shiny finished, stainless steel flatware set, serves sweets or a full course meal with simple line-trimmed handle.

ITEM	DESCRIPTION	U/M	WEIGHT GROSS lbs	INNER PACK	MASTER PACK	CU. FT.
SLTE102	Teaspoon	DOZEN	32.40	1	50	0.46
SLTE103	Bouillon Spoon	DOZEN	39.20	1	50	0.73
SLTE104	Dessert Spoon	DOZEN	45.60	1	50	0.75
SLTE106	Dinner Fork	DOZEN	40.50	1	50	0.60
SLTE107	Salad Fork	DOZEN	32.40	1	50	0.48
SLTE109	Dinner Knife	DOZEN	46.00	1	25	0.51



STAINLESS STEEL



↓ 2.0 mm to  
↑ 2.2 mm Thickness



**SALEM**

A durable satin finished, stainless steel flatware set, serves sweets or a full course meal with shaped decoration on handle neck.

ITEM	DESCRIPTION	U/M	WEIGHT GROSS lbs	INNER PACK	MASTER PACK	CU. FT.
SLAM102	Teaspoon	DOZEN	40.50	1	50	0.45
SLAM103	Bouillon Spoon	DOZEN	44.40	1	50	0.60
SLAM104	Dessert Spoon	DOZEN	57.70	1	50	0.69
SLAM105	Iced Tea Spoon	DOZEN	47.10	1	50	0.58
SLAM106	Dinner Fork	DOZEN	51.10	1	50	0.61
SLAM107	Salad Fork	DOZEN	35.20	1	50	0.41
SLAM109	Dinner Knife	DOZEN	50.00	1	25	0.34



↓ 2.0 mm to  
↑ 2.2 mm Thickness

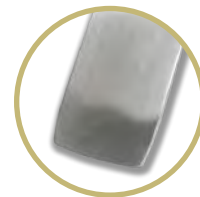

**ESQUIRE**

A durable satin finished, stainless steel flatware set.

ITEM	DESCRIPTION	U/M	WEIGHT GROSS lbs	INNER PACK	MASTER PACK	CU. FT.
SLES102	Teaspoon	DOZEN	40.50	1	50	0.45
SLES103	Bouillon Spoon	DOZEN	41.90	1	50	0.60
SLES104	Dessert Spoon	DOZEN	60.40	1	50	0.69
SLES105	Iced Tea Spoon	DOZEN	48.30	1	50	0.58
SLES106	Dinner Fork	DOZEN	47.00	1	50	0.61
SLES107	Salad Fork	DOZEN	41.90	1	50	0.41
SLES109	Dinner Knife	DOZEN	54.00	1	25	0.34



↓ 2.0 mm to  
↑ 2.2 mm Thickness





**LEGEND**

A durable mirror finished, stainless steel flatware set.

ITEM	DESCRIPTION	U/M	WEIGHT GROSS lbs	INNER PACK	MASTER PACK	CU. FT.
SLGD001	Sugar Spoon	DOZEN	24.06	1	36	0.32
SLGD002	Teaspoon	DOZEN	34.51	1	36	0.54
SLGD003	Bouillon Spoon	DOZEN	35.46	1	36	0.67
SLGD004	Dessert Spoon	DOZEN	51.62	1	36	0.84
SLGD005	Iced Tea Spoon	DOZEN	39.27	1	36	0.61
SLGD006	Dinner Fork	DOZEN	43.07	1	36	0.66
SLGD007	Salad Fork	DOZEN	35.46	1	36	0.62
SLGD008	Oyster Fork	DOZEN	20.26	1	36	0.33
SLGD009	Dinner Knife	DOZEN	43.07	1	18	0.33
SLGD010	Table Spoon	DOZEN	42.12	1	18	0.62
SLGD011	Dinner Butter Knife	DOZEN	36.41	1	36	0.35



↓ 2.5 mm to  
↑ 3.0 mm  
Thickness



**JEWEL**

A durable mirror finished, stainless steel flatware set.

ITEM	DESCRIPTION	U/M	WEIGHT GROSS lbs	INNER PACK	MASTER PACK	CU. FT.
SLNP001	Demitasse Spoon	DOZEN	22.00	1	50	0.37
SLNP002	Teaspoon	DOZEN	35.20	1	50	0.70
SLNP003	Bouillon Spoon	DOZEN	41.80	1	50	0.83
SLNP004	Dessert Spoon	DOZEN	60.28	1	50	0.97
SLNP005	Iced Tea Spoon	DOZEN	45.76	1	50	0.94
SLNP006	Dinner Fork	DOZEN	53.68	1	50	0.70
SLNP007	Salad Fork	DOZEN	33.88	1	50	0.80
SLNP008	Oyster Fork	DOZEN	31.24	1	50	0.46
SLNP009	Dinner Knife	DOZEN	39.16	1	20	0.31
SLNP010	Table Spoon	DOZEN	81.40	1	50	1.52
SLNP011	Dinner Butter Knife	DOZEN	35.20	1	50	0.50



↓ 2.5 mm to  
↑ 3.0 mm  
Thickness

## SUNFLOWER

A durable shiny finished, stainless steel flatware set, serves sweets or a full course meal with sunflower decoration handle.

ITEM	DESCRIPTION	U/M	WEIGHT GROSS lbs	INNER PACK	MASTER PACK	CU. FT.
SLSF111	Demitasse Spoon	DOZEN	24.64	1	50	0.36
SLSF112	Teaspoon	DOZEN	37.84	1	50	0.63
SLSF113	Bouillon Spoon	DOZEN	40.48	1	50	0.81
SLSF114	Dessert Spoon	DOZEN	48.40	1	50	1.01
SLSF115	Iced Tea Spoon	DOZEN	39.16	1	50	0.75
SLSF116	Dinner Fork	DOZEN	44.44	1	50	0.69
SLSF117	Salad Fork	DOZEN	36.52	1	50	0.53
SLSF118	Oyster Fork	DOZEN	28.60	1	50	0.51
SLSF119	Dinner Knife	DOZEN	39.16	1	20	0.29
SLSF120	Table Spoon	DOZEN	68.20	1	50	1.52



STAINLESS  
STEEL



↓ 1.8 mm to  
↑ 2.0 mm  
Thickness



## SEA SHELL

A durable mirror finished, stainless steel flatware set, serves sweets or a full course meal with sea shell decoration handle.

ITEM	DESCRIPTION	U/M	WEIGHT GROSS lbs	INNER PACK	MASTER PACK	CU. FT.
SLSS001	Sugar Spoon	DOZEN	21.21	1	36	0.53
SLSS002	Teaspoon	DOZEN	40.22	1	36	0.56
SLSS003	Bouillon Spoon	DOZEN	41.17	1	36	0.67
SLSS004	Dessert Spoon	DOZEN	60.17	1	36	0.95
SLSS005	Iced Tea Spoon	DOZEN	39.27	1	36	0.74
SLSS006	Dinner Fork	DOZEN	46.87	1	36	0.68
SLSS007	Salad Fork	DOZEN	37.36	1	36	0.52
SLSS008	Oyster Fork	DOZEN	25.96	1	36	0.42
SLSS009	Dinner Knife	DOZEN	41.17	1	18	0.34
SLSS010	Table Spoon	DOZEN	41.64	1	18	0.67
SLSS011	Butter Knife	DOZEN	32.61	1	36	0.69



STAINLESS  
STEEL



↓ 2.5 mm to  
↑ 3.0 mm  
Thickness





### DOMILION

A durable shiny finished, stainless steel flatware set, serves sweets or a full course meal with simple line-trimmed handle.

ITEM	DESCRIPTION	U/M	WEIGHT GROSS lbs	INNER PACK	MASTER PACK	CU. FT.
<b>Medium Weight</b> (thickness range from 1.5 mm)						
SLDO001	Sugar Spoon	DOZEN	15.20	1	36	0.26
SLDO002	Teaspoon	DOZEN	22.16	1	36	0.38
SLDO003	Bouillon Spoon	DOZEN	24.06	1	36	0.50
SLDO004	Dessert Spoon	DOZEN	29.76	1	36	0.58
SLDO005	Ice Tea Spoon	DOZEN	24.06	1	36	0.51
SLDO006	Dinner Fork	DOZEN	25.01	1	36	0.38
SLDO007	Salad Fork	DOZEN	21.21	1	36	0.33
SLDO008	Oyster Fork	DOZEN	15.51	1	36	0.21
SLDO009	Dinner Knife	DOZEN	43.07	1	36	0.37
SLDO011	Table Spoon	DOZEN	45.92	1	36	0.90
<b>Heavy Weight</b> (thickness range from 2.5 mm)						
SLDO102	Teaspoon	DOZEN	38.58	1	50	0.53
SLDO103	Bouillon Spoon	DOZEN	37.92	1	50	0.63
SLDO104	Dessert Spoon	DOZEN	47.82	1	50	0.85
SLDO105	Iced Tea Spoon	DOZEN	43.20	1	50	0.74
SLDO106	Dinner Fork	DOZEN	44.52	1	50	0.60
SLDO107	Salad Fork	DOZEN	36.60	1	50	0.44
SLDO109	Dinner Knife	DOZEN	37.50	1	25	0.26

↓ 1.5 mm  
↑ Thickness

↓ 2.5 mm to  
↑ 3.0 mm  
Thickness

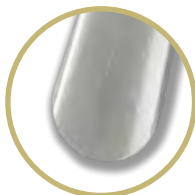

### WINDSOR

A durable shiny finished, stainless steel flatware set, serves sweets or a full course meal with simple line-trimmed handle.

ITEM	DESCRIPTION	U/M	WEIGHT GROSS lbs	INNER PACK	MASTER PACK	CU. FT.
<b>Medium Weight</b> (thickness range from 1.5 mm)						
SLWD001	Sugar Spoon	DOZEN	13.60	1	36	0.26
SLWD002	Teaspoon	DOZEN	23.11	1	36	0.38
SLWD003	Bouillon Spoon	DOZEN	25.96	1	36	0.50
SLWD004	Dessert Spoon	DOZEN	28.81	1	36	0.58
SLWD005	Ice Tea Spoon	DOZEN	26.91	1	36	0.51
SLWD006	Dinner Fork	DOZEN	25.96	1	36	0.38
SLWD007	Salad Fork	DOZEN	20.26	1	36	0.33
SLWD008	Oyster Fork	DOZEN	14.56	1	36	0.21
SLWD009	Dinner Knife	DOZEN	42.12	1	36	0.37
SLWD011	Table Spoon	DOZEN	45.92	1	36	0.90
<b>Heavy Weight</b> (thickness range from 2.5 mm)						
SLWD102	Teaspoon	DOZEN	38.58	1	50	0.53
SLWD103	Bouillon Spoon	DOZEN	37.92	1	50	0.63
SLWD104	Dessert Spoon	DOZEN	47.82	1	50	0.85
SLWD105	Iced Tea Spoon	DOZEN	43.20	1	50	0.74
SLWD106	Dinner Fork	DOZEN	44.52	1	50	0.60
SLWD107	Salad Fork	DOZEN	36.60	1	50	0.44
SLWD109	Dinner Knife	DOZEN	37.50	1	25	0.26

↓ 1.5 mm  
↑ Thickness

↓ 2.5 mm to  
↑ 3.0 mm  
Thickness



### TRAY STAND

Folding chrome plated tray stand with 2 ribbon bars for supporting tras.  
Folds neatly aside.

ITEM	DESCRIPTION	U/M	WEIGHT GROSS lbs	INNER PACK	MASTER PACK	CU. FT
WDTHS032	Double Bar, Mahogany Wood 17½" x 17" x 33½"	EACH	9.46	1	1	1.64
SLTS001	Folding Type, Chrome Plated 19" x 16½" x 30½"	EACH	28.66	1	6	3.25
SLTS002	Double Bar, Chrome Plated 19" x 17½" x 31½"	EACH	33.06	1	6	3.30



### CHILDREN'S HIGH CHAIR

Stable wooden chair, with safety harness straps and wide stance to avoid tipping over.  
**\*\* SHIPS KNOCKED DOWN \*\***



ITEM	DESCRIPTION	U/M	WEIGHT GROSS lbs	INNER PACK	MASTER PACK	CU. FT.
WDTHHC018A	Natural Wood 20" x 22½" x 29½" Seat size: 10⅞" x 6⅔"	EACH	11.9	1	1	0.72
WDTHHC019A	Walnut Wood 20" x 22½" x 29½" Seat size: 10⅞" x 6⅔"	EACH	11.9	1	1	0.72
WDTHHC020A	Mahogany Wood 20" x 22½" x 29½" Seat size: 10⅞" x 6⅔"	EACH	11.9	1	1	0.72



### CHILDREN'S WOOD BOOSTER SEAT

Stable wooden booster, with safety harness straps.  
**\*\* SHIPS KNOCKED DOWN \*\***

ITEM	DESCRIPTION	U/M	WEIGHT GROSS lbs	INNER PACK	MASTER PACK	CU. FT.
WDTHBS018	Natural Wood 11⅞" x 11⅞" x 10⅞", Seat back support: Maximum 17"	EACH	46.20	1	6	1.94
WDTHBS019	Walnut Finish Wood 11⅞" x 11⅞" x 10⅞", Seat back support: Maximum 17"	EACH	46.20	1	6	1.94
WDTHBS020	Mahogany Finish Wood 11⅞" x 11⅞" x 10⅞", Seat back support: Maximum 17"	EACH	46.20	1	6	1.94



Stackable



WDTHBS018



WDTHBS019



WDTHBS020

## INFORMATION SIGN WITH SYMBOLS

6" x 9" information sign with symbol.

U/M	WEIGHT GROSS lbs	INNER PACK	MASTER PACK	CU. FT.
EACH	20.13	12	72	0.77



Easy peel self-adhesive backing.



PLIS6901BK    PLIS6902BK    PLIS6903BL    PLIS6904RD    PLIS6905RD    PLIS6906RD    PLIS6907RD



PLIS6908BK    PLIS6909BL    PLIS6910RD    PLIS6911BL    PLIS6912BK    PLIS6913RD    PLIS6914BL

ITEM	DESCRIPTION
PLIS6901BK	"We Are Pleased to Provide All Our Guests A Smoke-Free Environment"
PLIS6902BK	"Smoking Area"
PLIS6903BL	"Restroom/Accessible"
PLIS6904RD	"In Case of Fire Do Not Use Elevator Use Stairwell"
PLIS6905RD	"No Smoking Area"
PLIS6906RD	"Smoking Area"
PLIS6907RD	"Exit"
PLIS6908BK	"Restrooms"
PLIS6909BL	"Women/ Accessible"
PLIS6910RD	"No Smoking Area Available"
PLIS6911BL	"Accessible"
PLIS6912BK	"No Smoking"
PLIS6913RD	"Fire Extinguisher"
PLIS6914BL	"Men/ Accessible"



**RAISED INFORMATION SIGN WITH SYMBOLS AND BRAILLE**

6" x 9" Information sign with braille and self adhesive backing for easy mounting.



Easy peel self-adhesive backing.

U/M	WEIGHT GROSS lbs	INNER PACK	MASTER PACK	CU. FT.
EACH	20.92	6	72	0.68



PLIS6951BK



PLIS6952BK



PLIS6953BK

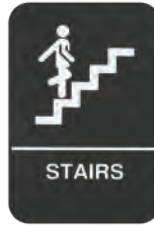

PLIS6954BK



PLIS6955BK



PLIS6956BK



PLIS6957BL



PLIS6958BL



PLIS6959BL



PLIS6960BL



PLIS9601BK



ITEM	DESCRIPTION
PLIS6951BK	"Women"
PLIS6952BK	"Men"
PLIS6953BK	"Restroom"
PLIS6954BK	"Stairs"
PLIS6955BK	"No Smoking"
PLIS6956BK	"Exit"
PLIS6957BL	"Women/Accessible"
PLIS6958BL	"Men/Accessible"
PLIS6959BL	"Accessible"
PLIS6960BL	"Restroom/Accessible"
PLIS9601BK	"Family Restroom/Accessible"



## INFORMATION SIGN WITH SYMBOL

9" x 3" information sign with symbols.

U/M	WEIGHT GROSS lbs	INNER PACK	MASTER PACK	CU. FT.
EACH	20.13	12	144	0.77



Easy peel  
self-adhesive  
backing.

3/8" Thickness



PLIS9301BK



PLIS9302BK



PLIS9303BK



PLIS9304BK



PLIS9305BK



PLIS9306BK



PLIS9307RD



PLIS9308BK



PLIS9309BK



PLIS9310BK



PLIS9311BK



PLIS9312BK



PLIS9313BK



PLIS9314BK

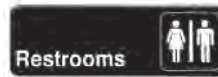

PLIS9315BK



PLIS9316RD



PLIS9317BK



PLIS9318BK



PLIS9319BK



PLIS9320BK

ITEM	DESCRIPTION
PLIS9301BK	"Push"
PLIS9302BK	"Pull"
PLIS9303BK	"Private"
PLIS9304BK	"Employees Only"
PLIS9305BK	"No Admittance"
PLIS9306BK	"No Exit"
PLIS9307RD	"Exit"
PLIS9308BK	"Out"
PLIS9309BK	"In"
PLIS9310BK	"Entrance"
PLIS9311BK	"No Smoking"
PLIS9312BK	"Smoking Permitted"
PLIS9313BK	"Men"
PLIS9314BK	"Women"
PLIS9315BK	"Restrooms"
PLIS9316RD	"Fire Extinguisher"
PLIS9317BK	"No Checks Please"
PLIS9318BK	"Thank You For Not Smoking"
PLIS9319BK	"No Pets/Shoes, Shirt Required"
PLIS9320BK	"This is a Smoke-Free Restaurant"





## INFORMATION SIGN WITH SYMBOL

9" x 3" information sign with symbols.

U/M	WEIGHT GROSS lbs	INNER PACK	MASTER PACK	CU. FT.
EACH	20.13	12	144	0.77



Easy peel self-adhesive backing.

1/8" Thickness

9"

3"

PLIS9321BK	PLIS9322BK	PLIS9323BK	PLIS9341BK
PLIS9325BK	PLIS9326BK	PLIS9327BK	PLIS9324BK
PLIS9329BK	PLIS9330BK	PLIS9331BK	PLIS9328BK
PLIS9333BK	PLIS9334BK	PLIS9335BK	PLIS9336BK
PLIS9337BK	PLIS9337BK	PLIS9339BK	PLIS9340BK



ITEM	DESCRIPTION
PLIS9321BK	"Restrooms For Customer Use Only"
PLIS9322BK	"No Soliciting"
PLIS9323BK	"Office"
PLIS9324BK	"Microwave Oven in Operation"
PLIS9325BK	"Employees Must Wash Hands Before Returning to Work"
PLIS9326BK	"Not Responsible for Lost Or Stolen Articles"
PLIS9327BK	"Smoking Permitted in Designated Area Only"
PLIS9328BK	"Telephone"
PLIS9329BK	"Caution, Watch Your Step"
PLIS9330BK	"No Shirt, No Shoes, No Service"
PLIS9331BK	"No Food or Drink"
PLIS9332BK	"No Cell Phone Use, Please"
PLIS9333BK	"Hand Wash Only"
PLIS9334BK	"Please Let Us Know If the Restroom Needs Attention"
PLIS9335BK	"No Public Restrooms"
PLIS9336BK	"WIFI"
PLIS9337BK	"No E-Cigarettes"
PLIS9338BK	"RESERVED"
PLIS9339BK	"RINSE"
PLIS9340BK	"SANITIZE"
PLIS9341BK	"WASH"



**COMMERCIAL WIRE SHELVING - CHROME PLATED**

Chrome plated wire shelving. Adjustable legs for leveling on uneven surfaces.

**\*\*Each shelf maximum capacity is 150 lbs per shelf on casters.\*\***



ITEM	DESCRIPTION	SHELF WEIGHT CAPACITY	U/M	WEIGHT GROSS lbs	INNER PACK	MASTER PACK	CU. FT.
<b>Shelf w/ 4 Set of Sleeve Clips</b>							
CMSV1424	14" x 24"	600 lbs	EACH	11.68	2	2	0.80
CMSV1430	14" x 30"	600 lbs	EACH	14.11	2	2	0.99
CMSV1436	14" x 36"	600 lbs	EACH	16.53	2	2	1.18
CMSV1448	14" x 48"	600 lbs	EACH	21.61	2	2	1.57
CMSV1460	14" x 60"	850 lbs	EACH	26.68	2	2	1.96
CMSV1472	14" x 72"	850 lbs	EACH	31.31	2	2	2.34
CMSV1824	18" x 24"	600 lbs	EACH	13.23	2	2	1.01
CMSV1830	18" x 30"	600 lbs	EACH	16.09	2	2	1.25
CMSV1836	18" x 36"	600 lbs	EACH	18.74	2	2	1.50
CMSV1842	18" x 42"	600 lbs	EACH	21.61	2	2	1.75
CMSV1848	18" x 48"	600 lbs	EACH	24.25	2	2	1.99
CMSV1854	18" x 54"	850 lbs	EACH	26.90	2	2	2.24
CMSV1860	18" x 60"	850 lbs	EACH	29.76	2	2	2.49
CMSV1872	18" x 72"	850 lbs	EACH	34.83	2	2	2.98
CMSV2124	21" x 24"	600 lbs	EACH	14.44	2	2	1.18
CMSV2130	21" x 30"	600 lbs	EACH	17.53	2	2	1.46
CMSV2136	21" x 36"	600 lbs	EACH	20.39	2	2	1.74
CMSV2142	21" x 42"	600 lbs	EACH	23.26	2	2	2.03
CMSV2148	21" x 48"	600 lbs	EACH	26.12	2	2	2.21
CMSV2154	21" x 54"	850 lbs	EACH	28.99	2	2	2.61
CMSV2160	21" x 60"	850 lbs	EACH	32.08	2	2	2.89
CMSV2172	21" x 72"	850 lbs	EACH	37.59	2	2	3.46
CMSV2424	24" x 24"	600 lbs	EACH	16.53	2	2	1.33
CMSV2430	24" x 30"	600 lbs	EACH	19.84	2	2	1.65
CMSV2436	24" x 36"	600 lbs	EACH	22.93	2	2	1.98
CMSV2442	24" x 42"	600 lbs	EACH	26.23	2	2	2.31
CMSV2448	24" x 48"	600 lbs	EACH	29.54	2	2	2.63
CMSV2454	24" x 54"	850 lbs	EACH	32.85	2	2	2.97
CMSV2460	24" x 60"	850 lbs	EACH	39.24	2	2	3.29
CMSV2472	24" x 72"	850 lbs	EACH	46.08	2	2	3.94
<b>Post w/ Leveling Foot</b>							
CMPC008	8" Post with Leveling Foot		EACH	1.98	4	4	0.04
CMPC034	34" Post with Leveling Foot		EACH	6.17	4	4	0.13
CMPC063	63" Post with Leveling Foot		EACH	11.00	4	4	0.24
CMPC072	74" Post with Leveling Foot		EACH	13.18	4	4	0.28
CMPC086	86" Post with Leveling Foot		EACH	15.65	4	4	0.33

**\* Sold by Master Pack Only.**



Chrome Shelves



Posts



Leveling Foot Included



Sleeve Clips

## COMMERCIAL WIRE SHELVING - EPOXY COATED

Epoxy coated wire shelving endures in moist areas. Adjustable legs for leveling on uneven surfaces.

**\*\*Each shelf maximum capacity is 150 lbs per shelf on casters.\*\***



ITEM	DESCRIPTION	SHELF WEIGHT CAPACITY	U/M	WEIGHT GROSS lbs	INNER PACK	MASTER PACK	CU. FT.
<b>Shelf w/ 4 Set of Sleeve Clips</b>							
CMEP1424	14" x 24"	600 lbs	EACH	11.68	2	2	0.80
CMEP1430	14" x 30"	600 lbs	EACH	14.11	2	2	0.99
CMEP1436	14" x 36"	600 lbs	EACH	16.53	2	2	1.18
CMEP1448	14" x 48"	600 lbs	EACH	21.61	2	2	1.57
CMEP1460	14" x 60"	850 lbs	EACH	26.68	2	2	1.96
CMEP1472	14" x 72"	850 lbs	EACH	31.31	2	2	2.34
CMEP1824	18" x 24"	600 lbs	EACH	13.23	2	2	1.01
CMEP1830	18" x 30"	600 lbs	EACH	16.09	2	2	1.25
CMEP1836	18" x 36"	600 lbs	EACH	18.74	2	2	1.50
CMEP1842	18" x 42"	600 lbs	EACH	21.61	2	2	1.75
CMEP1848	18" x 48"	600 lbs	EACH	24.25	2	2	1.99
CMEP1854	18" x 54"	850 lbs	EACH	26.90	2	2	2.24
CMEP1860	18" x 60"	850 lbs	EACH	29.76	2	2	2.49
CMEP1872	18" x 72"	850 lbs	EACH	34.83	2	2	2.98
CMEP2124	21" x 24"	600 lbs	EACH	14.44	2	2	1.18
CMEP2130	21" x 30"	600 lbs	EACH	17.53	2	2	1.46
CMEP2136	21" x 36"	600 lbs	EACH	20.39	2	2	1.74
CMEP2142	21" x 42"	600 lbs	EACH	23.26	2	2	2.03
CMEP2148	21" x 48"	600 lbs	EACH	26.12	2	2	2.21
CMEP2154	21" x 54"	850 lbs	EACH	28.99	2	2	2.61
CMEP2160	21" x 60"	850 lbs	EACH	32.08	2	2	2.89
CMEP2172	21" x 72"	850 lbs	EACH	37.59	2	2	3.46
CMEP2424	24" x 24"	600 lbs	EACH	16.53	2	2	1.33
CMEP2430	24" x 30"	600 lbs	EACH	19.84	2	2	1.65
CMEP2436	24" x 36"	600 lbs	EACH	22.93	2	2	1.98
CMEP2442	24" x 42"	600 lbs	EACH	26.23	2	2	2.31
CMEP2448	24" x 48"	600 lbs	EACH	29.54	2	2	2.63
CMEP2454	24" x 54"	850 lbs	EACH	32.85	2	2	2.97
CMEP2460	24" x 60"	850 lbs	EACH	39.24	2	2	3.29
CMEP2472	24" x 72"	850 lbs	EACH	46.08	2	2	3.94
<b>Post w/ Leveling Foot</b>							
CMEC008	8" Post		EACH	1.98	4	4	0.04
CMEC034	34" Post		EACH	6.17	4	4	0.13
CMEC063	63" Post		EACH	11.02	4	4	0.24
CMEC072	74" Post		EACH	13.18	4	4	0.28
CMEC086	86" Post		EACH	15.65	4	4	0.33

\* Sold by Master Pack Only.

Sleeve Clips



Leveling Foot Included



Posts

Green Epoxy Shelves



## SHELVING ACCESSORIES

Wheels available with locking and non locking feature, 198 lbs. capacity.



ITEM	DESCRIPTION	U/M	WEIGHT GROSS lbs	INNER PACK	MASTER PACK	CU. FT.
<b>Accessories</b>						
ALFN001	Shelving Knob for Post, 1" x 1"	EACH	39.46	4	500	0.71
ALFP001	Foot Plate, 2 $\frac{3}{8}$ " x 2 $\frac{1}{8}$ " x 1 $\frac{1}{8}$ "	EACH	45.15	1	500	1.41
ALFP002	Post Clamp, 3 $\frac{1}{4}$ " x 7 $\frac{1}{8}$ " x 1 $\frac{3}{8}$ "	EACH	67.18	1	500	0.88
ALSH001	S Hook, 1 $\frac{3}{8}$ " x 5 $\frac{1}{8}$ " x 1"	EACH	27.53	1	500	0.71
ALSH001EP	S Hook, Green Epoxy, 1 $\frac{3}{8}$ " x 5 $\frac{1}{8}$ " x 1"	EACH	25.73	4	500	0.71
PLDLF001	Leveling Foot, 1" x 1" x 2"	EACH	39.46	4	500	0.71
PLRPSS	Split Sleeve Shelf Clips, 2pc/set 1 $\frac{1}{2}$ " x 1 $\frac{1}{8}$ " x 1 $\frac{3}{8}$ "	SET	9.14	4	500	1.13



ITEM	DESCRIPTION	U/M	WEIGHT GROSS lbs	INNER PACK	MASTER PACK	CU. FT.
<b>Rubber Wheel</b>						
PLCB5140	5": 5 $\frac{1}{2}$ " x 2 $\frac{1}{4}$ " x 7 $\frac{3}{4}$ ", Wheel size: 5" Diameter x 1 $\frac{1}{4}$ " Width	EACH	51.81	1	18	0.97
PLCB5140B	5" with Brake: 5 $\frac{1}{2}$ " x 3 $\frac{1}{2}$ " x 7 $\frac{3}{4}$ ", Wheel size: 5" Diameter x 1 $\frac{1}{4}$ " Width	EACH	50.71	1	16	0.97
PLCB3140	3": 3 $\frac{1}{8}$ " x 2" x 5 $\frac{1}{8}$ ", Wheel size: 3" Diameter x 1" Width	EACH	22.58	1	24	0.28
PLCB3140B	3" with Brake: 3 $\frac{1}{8}$ " x 2" x 5 $\frac{1}{8}$ ", Wheel size: 3" Diameter x 1" Width	EACH	25.35	1	24	0.35

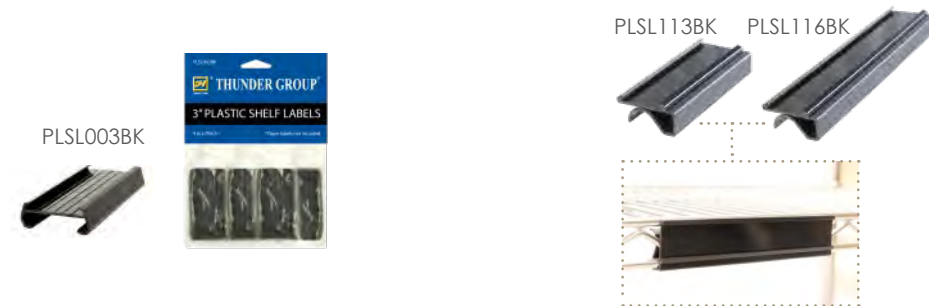

ITEM	DESCRIPTION	U/M	WEIGHT GROSS lbs	INNER PACK	MASTER PACK	CU. FT.
<b>Plastic Shelf Label, Black</b>						
PLSL003BK	3", 4pcs/pack: 3" x 1 $\frac{3}{8}$ " x 5 $\frac{1}{8}$ ", Label Size: 3 $\frac{1}{8}$ " x 1"	PACK	24.65	1	250	2.43
PLSL006BK	6", 4pcs/pack: 6" x 1 $\frac{3}{8}$ " x 5 $\frac{1}{8}$ ", Label Size: 6" x 1"	PACK	22.00	1	125	2.25
PLSL113BK	3" Snap-Under Shelf Label, 4pcs/pack, 3" x 1 $\frac{3}{8}$ " x 5 $\frac{1}{8}$ "	PACK	35.00	1	250	2.43
PLSL116BK	6" Snap-Under Shelf Label, 4pcs/pack, 6" x 1 $\frac{3}{8}$ " x 5 $\frac{1}{8}$ "	PACK	35.00	1	125	2.25



## SHELVING PARTS

ITEM	DESCRIPTION	U/M	WEIGHT GROSS lbs	INNER PACK	MASTER PACK	CU. FT.
<b>Chrome Plated, Wall Bracket</b>						
<b>Single</b>						
WBSV014	14" x 2 $\frac{5}{8}$ " x 7 $\frac{3}{4}$ "	EACH	6.61	1	4	0.36
WBSV018	18" x 2 $\frac{1}{2}$ " x 7 $\frac{3}{4}$ "	EACH	8.82	1	4	0.50
WBSV021	21" x 3" x 7 $\frac{1}{4}$ "	EACH	9.26	1	4	0.53
WBSV024	24" x 2 $\frac{1}{2}$ " x 7 $\frac{1}{8}$ "	EACH	9.92	1	4	0.60
<b>Double</b>						
WBSV214	14" x 11 $\frac{1}{4}$ " x 1 $\frac{1}{2}$ "	EACH	13.23	1	4	0.67
WBSV218	18" x 11 $\frac{1}{4}$ " x 1 $\frac{1}{2}$ "	EACH	17.02	1	4	0.88
WBSV221	21" x 11 $\frac{1}{4}$ " x 1 $\frac{1}{2}$ "	EACH	17.90	1	4	0.99
WBSV224	24" x 11 $\frac{1}{4}$ " x 1 $\frac{1}{2}$ "	EACH	19.22	1	4	1.06
<b>Chrome Plated Shelf Divider</b>						
CMDC014	14" Pressure-fit: 14" x 2 $\frac{1}{8}$ " x 9 $\frac{5}{8}$ "	EACH	11.38	1	12	0.71
CMDC018	18" Pressure-fit: 18" x 2 $\frac{1}{8}$ " x 9 $\frac{3}{8}$ "	EACH	16.40	1	12	0.85
CMDC021	21" Pressure-fit: 21" x 2 $\frac{1}{8}$ " x 9 $\frac{1}{2}$ "	EACH	17.72	1	12	0.99
CMDC024	24" Pressure-fit: 24" x 2 $\frac{1}{8}$ " x 9 $\frac{1}{2}$ "	EACH	20.11	1	12	1.10
<b>Chrome Plated Cart Extended Handle</b>						
CMCH014	14": 14" x 5 $\frac{3}{4}$ " x 1 $\frac{3}{8}$ "	EACH	13.01	1	12	0.82
CMCH018	18": 18" x 5 $\frac{3}{4}$ " x 1 $\frac{3}{8}$ "	EACH	17.42	1	12	1.04
CMCH021	21": 21" x 5 $\frac{3}{4}$ " x 1 $\frac{3}{8}$ "	EACH	18.30	1	12	1.21
CMCH024	24": 24" x 5 $\frac{3}{4}$ " x 1 $\frac{3}{8}$ "	EACH	18.96	1	12	1.84



ITEM	DESCRIPTION	U/M	WEIGHT GROSS lbs	INNER PACK	MASTER PACK	CU. FT.
<b>Green Epoxy Coated, Wall Bracket</b>						
<b>Single</b>						
WBEP014	14" : 14" x 2 $\frac{5}{8}$ " x 7 $\frac{3}{4}$ "	EACH	6.61	1	4	0.36
WBEP018	18" : 18" x 2 $\frac{1}{2}$ " x 7 $\frac{3}{4}$ "	EACH	8.82	1	4	0.50
WBEP021	21" : 21" x 3" x 7 $\frac{1}{4}$ "	EACH	9.26	1	4	0.53
WBEP024	24" : 24" x 2 $\frac{1}{2}$ " x 7 $\frac{1}{8}$ "	EACH	9.92	1	4	0.60
<b>Double</b>						
WBEP214	14" : 14" x 11 $\frac{1}{4}$ " x 1 $\frac{1}{2}$ "	EACH	13.23	1	4	0.67
WBEP218	18" : 18" x 11 $\frac{1}{4}$ " x 1 $\frac{1}{2}$ "	EACH	17.02	1	4	0.88
WBEP221	21" : 21" x 11 $\frac{1}{4}$ " x 1 $\frac{1}{2}$ "	EACH	17.90	1	4	0.99
WBEP224	24" : 24" x 11 $\frac{1}{4}$ " x 1 $\frac{1}{2}$ "	EACH	19.22	1	4	1.06
<b>Green Epoxy Coated, Shelf Divider</b>						
CMDE014	14" Pressure-fit, 14" x 2 $\frac{1}{8}$ " x 9 $\frac{5}{8}$ "	EACH	11.38	1	12	0.71
CMDE018	18" Pressure-fit, 18" x 2 $\frac{1}{8}$ " x 9 $\frac{3}{8}$ "	EACH	16.40	1	12	0.85
CMDE021	21" Pressure-fit, 21" x 2 $\frac{1}{8}$ " x 9 $\frac{1}{2}$ "	EACH	17.72	1	12	0.99
CMDE024	24" Pressure-fit, 24" x 2 $\frac{1}{8}$ " x 9 $\frac{1}{2}$ "	EACH	20.11	1	12	1.10



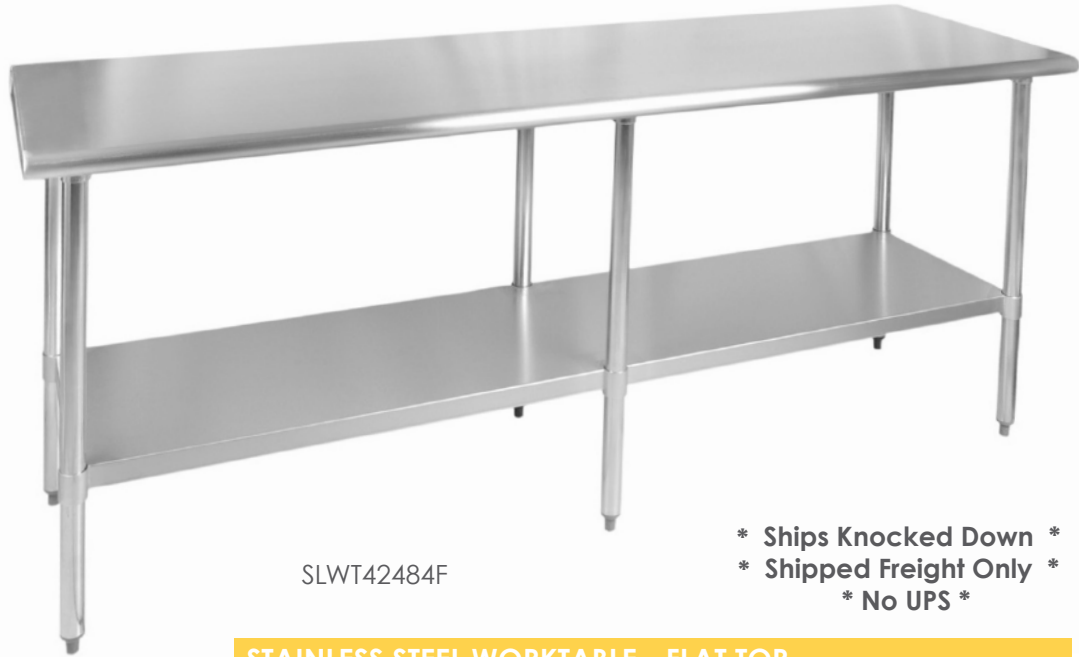

SLWT42484F

\* Ships Knocked Down \*  
 \* Shipped Freight Only \*  
 \* No UPS \*



Curved Edges



Adjustable Feet

**STAINLESS STEEL WORKTABLE - FLAT TOP**

Stainless steel worktable surface has curved edges for safety and comfort. It incorporates a heavy duty adjustable galvanized under shelf and leveling feet. Heavy duty 5" Casters are available and sold separately.



ITEM	DESCRIPTION	U/M	WEIGHT GROSS lbs	INNER PACK	MASTER PACK	CU. FT.
SLWT42412F	24" x 12" x 35"	SET	28.60	1	1	1.38
SLWT42418F	24" x 18" x 35"	SET	33.00	1	1	1.87
SLWT42424F	24" x 24" x 35"	SET	37.40	1	1	2.36
SLWT42430F	24" x 30" x 35"	SET	41.80	1	1	2.36
SLWT42436F	24" x 36" x 35"	SET	46.20	1	1	1.92
SLWT42448F	24" x 48" x 35"	SET	55.00	1	1	2.53
SLWT42460F	24" x 60" x 35"	SET	66.00	1	1	3.15
SLWT42472F	24" x 72" x 35"	SET	74.80	1	1	3.76
SLWT42484F*	24" x 84" x 35"	SET	90.20	1	1	4.38
SLWT42496F*	24" x 96" x 35"	SET	99.00	1	1	4.99
SLWT43012F	30" x 12" x 35"	SET	30.80	1	1	1.38
SLWT43018F	30" x 18" x 35"	SET	36.30	1	1	1.87
SLWT43024F	30" x 24" x 35"	SET	41.80	1	1	2.36
SLWT43030F	30" x 30" x 35"	SET	47.30	1	1	2.85
SLWT43036F	30" x 36" x 35"	SET	52.80	1	1	2.37
SLWT43048F	30" x 48" x 35"	SET	66.00	1	1	3.14
SLWT43060F	30" x 60" x 35"	SET	77.00	1	1	3.90
SLWT43072F	30" x 72" x 35"	SET	88.00	1	1	4.66
SLWT43084F*	30" x 84" x 35"	SET	105.60	1	1	5.42
SLWT43096F*	30" x 96" x 35"	SET	118.80	1	1	6.19

SLWT42424F



SLWT42448F



\* 84" and 96" models have 6 legs for extra strength and support.



\* Ships Knocked Down \*  
 \* Shipped Freight Only \*  
 \* No UPS \*

SLWT42484F4

**WORKTABLE, FLAT TOP WITH 4" BACKSPASH**

Stainless steel heavy duty worktable with backsplash. Suitable for commercial kitchen.



ITEM	DESCRIPTION	U/M	WEIGHT GROSS lbs	INNER PACK	MASTER PACK	CU. FT.
SLWT42448F4	24" x 48" x 35"	SET	56.15	1	1	6.06
SLWT42460F4	24" x 60" x 35"	SET	66.07	1	1	7.48
SLWT42472F4	24" x 72" x 35"	SET	76.06	1	1	8.94
SLWT42484F4*	24" x 84" x 35"	SET	92.95	1	1	10.38
SLWT42496F4*	24" x 96" x 35"	SET	102.80	1	1	11.83
SLWT43048F4	30" x 48" x 35"	SET	64.86	1	1	7.43
SLWT43060F4	30" x 60" x 35"	SET	85.69	1	1	9.17
SLWT43072F4	30" x 72" x 35"	SET	88.93	1	1	10.97
SLWT43084F4*	30" x 84" x 35"	SET	107.83	1	1	12.73
SLWT43096F4*	30" x 96" x 35"	SET	119.89	1	1	14.51



Curved Edges



1" Adjustable Feet



4" Backsplash

**WORKTABLE CASTER**



ITEM	DESCRIPTION	U/M	WEIGHT GROSS lbs	INNER PACK	MASTER PACK	CU. FT.
SLWTC005	5"	EACH	36.76	1	16	0.90
SLWTC005B	5" with Brake	EACH	41.75	1	16	0.90



Brake Close Up



Stem Close Up



**CONVERSION CHART**

**LINEAR MEASUREMENT**

1 mil	=	0.001 inch	=	0.0254 millimeter
1 inch	=	1,000 mils	=	2.54 centimeter
12 inch	=	1 foot	=	0.3048 meter
3 feet	=	1 yard	=	0.9144 meter

**SQUARE MEASUREMENT**

-	=	1 sq inch	=	6,452 sq centimeter
144 sq inch	=	1 sq foot	=	929.03 sq centimeter
1296 sq inch	=	1 sq yard	=	0.83161 sq meter

**CUBIC MEASUREMENT**

-	=	1 cubic inch	=	16.387 cubic centimeter
1728 cubic inches	=	1 cubic foot	=	0.0283 cubic meter
27 cubic feet	=	1 cubic yard	=	0.7646 cubic meter

**DRY MEASUREMENT**

1 pint	=	33.6 cubic inches	=	0.5506 liter
2 pint (1 quart)	=	67.2 cubic inches	=	1.1012 liter
8 quart	=	537.61 cubic inches	=	8.8098 liter

**LIQUID MEASUREMENT**

1 fluid oz	=	1.805 cubic inches	=	29.57 ml
4 fluid oz	=	7.219 cubic inches	=	0.1183 liter
1 pint	=	28.875 cubic inches	=	0.4732 liter
2 pint (1 quart)	=	57.75 cubic inches	=	0.9464 liter
4 pint (2 quart)	=	115.5 cubic inches	=	1.8927 liter

**AVOIRDUPOIS MEASUREMENT**

1 oz	=	0.0625 lbs	=	28.3495 grams
16 oz	=	1 lb	=	453.59 grams
100lbs	=	1 hundred-weight	=	45.36 grams
2000lbs	=	1 Short ton	=	907.18 kg

**CONVERSION**

Inches x 25.4 = mm	=	1.805 cubic inches	=	29.57 ml
Inches x 2.54 = cm	=	7.219 cubic inches	=	0.1183 liter
mm x 0.03937 =	=	28.875 cubic inches	=	0.4732 liter
2 pint (1 quart)	=	57.75 cubic inches	=	0.9464 liter
4 pint (2 quart)	=	231 cubic inches	=	3.7854 liter



**CONVERSION CHART**

2023

**ALUMINUM GAUGE CONVERSION CHART**

INCHES	DECIMAL	mm	GAUGE
1/64	0.1526	-	-
-	0.0201	-	24
-	0.0226	-	23
-	0.0253	-	22
-	0.0285	-	21
1/32	0.03125	0.794	-
-	0.03125	0.800	-
-	0.020	-	20
-	0.0359	-	19
-	0.03937	1.000	-
-	0.0403	-	18
-	0.0453	-	17
3/64	0.046875	1.190	-
-	0.0508	-	16
-	0.0571	-	15
1/16	0.0625	1.587	-
-	0.063	-	-
-	0.0641	-	14
-	0.0720	-	13
5/64	0.078125	1.984	-
-	0.07874	2.000	-
-	0.0808	-	12
-	0.0907	-	11
3/32	0.09375	2.381	-
-	0.098425	2.500	-
-	0.1019	-	10
7/64	0.109375	2.778	-
-	0.1144	-	9
-	0.11811	3.000	-
-	0.1250	3.175	-
-	0.1285	-	8
-	0.137795	3.500	-
9/64	0.140625	3.571	-
-	0.1443	-	7
5/32	0.15625	3.968	-
-	0.15748	4.000	6.25
-	0.1620	-	6
11/64	0.171875	4.365	-
-	0.177165	4.5000	-
-	0.1819	-	5
3/16	0.1875	4.762	-
-	0.19685	5.000	-
13/64	0.203125	5.159	-
-	0.2043	-	4
-	0.216535	5.500	-
7/32	0.21875	5.556	-
-	0.2294	-	3
15/64	0.234375	5.953	-
-	0.23622	6.000	-
1/4	0.250	6.350	-
-	0.2576	-	2
-	0.2893	-	1

**STAINLESS STEEL GAUGE CONVERSION CHART**

INCHES	DECIMAL	mm	GAUGE
1/64	0.15265	-	28
-	0.015625	-	-
-	0.015748	0.396	-
-	0.0179	0.4	26
-	0.0209	-	25
-	0.023622	0.6	-
-	0.0239	-	24
-	0.0269	-	23
-	0.027559	0.7	-
-	0.0299	-	22
1/32	0.03125	0.794	-
-	0.031496	0.8	-
-	0.0329	-	21
-	0.035433	0.9	-
-	0.0359	-	20
-	0.03937	1.0	-
-	0.0418	-	19
3/64	0.0465875	1.19	-
-	0.047244	1.2	-
-	0.0478	-	18
-	0.0538	-	17
-	0.059055	1.5	-
-	0.0598	-	16
1/16	0.0625	1.567	-
-	0.0673	-	15
-	0.0747	-	14
5/64	0.078125	1.984	-
-	0.07874	2.0	-
-	0.086614	2.2	-
-	0.0897	-	13
-	0.09375	2.381	-
-	0.094488	2.4	-
-	0.098425	2.5	-
-	0.1046	-	12
-	0.106299	2.7	-
7/64	0.109375	2.778	-
-	0.11811	3.0	-
-	0.1196	-	11
1/8	0.125	3.175	-
-	0.1345	-	10
-	0.1495	-	9
5/32	0.15625	3.968	-
-	0.15748	4.000	-
-	0.1644	-	8
-	0.1793	-	7
3/16	0.1875	4.762	-
-	0.188976	4.8	-
-	0.192913	4.9	-
-	0.1793	-	6
13/64	0.203125	5.159	-
-	0.2092	-	5
-	0.23622	-	4
-	0.23622	6.0	-
-	0.2391	-	3
1/4	0.250	6.5	-

CONVERSION CHART

# Catalog Icon Legend



New for 2023



Shatter Resistant



Dishwasher Safe



Break Resistant



Not for Dishwasher



Not for Oven



Not for Microwave

18/10



STAINLESS STEEL

Made of 18/10 Stainless Steel

18/8



STAINLESS STEEL

Made of 18/8 Stainless Steel



STAINLESS STEEL



ALUMINUM



GALVANIZED



POLYPROPYLENE



POLYCARBONATE



No electricity needed



UL Certified



UL Certified US



ETL Certified

Intertek  
4003935



ETL Certified US

Intertek  
4003935



ASTM 404 Certified



NSF Certified



CSA Certified



High-density Polyethylene & Recycled No. 2

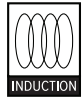

Induction Ready



Halogen Ready



Gas Ready



Electric Ready



Heavy Duty



Heavy Weight



This item is temperature safe from -40 to 210° F

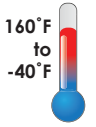

This item is temperature safe from -40 to 160° F



Sold as Master Pack only

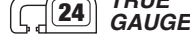

Food/ Liquid Hold Time:  
Time Food/ Liquid will keep their temperature



Airpots:  
Bottom of base rotates



Thunder Group Inc.  
Warranty



Thunder Group Inc.  
Patented Item



All product names, logos, brands, trademarks and registered trademarks are property of their respective owners.

## Index By Item Number

Item #	Page #	Item #	Page #	Item #	Page #	Item #	Page #
29	181	3601	139	1003TR	108	1012TB	110
30	181	3703	139	1003TW	102	1012TP	116
53	181	3704	137	1004AR	126	1012TR	104
1704	139	3705	138	1004DL	97	1012TW	99
1707	136	3706	137	1004TB	114	1013AR	122
1708	136	3707	137	1004TP	120	1013DL	93
1710	136	3904	158	1004TR	108	1013TB	110
1712	136	3905	158	1004TW	102	1013TP	116
1806	136	3906	158	1006AR	122	1013TR	104
1807	136	3935	158	1006BB	128	1013TW	99
1808	136	3945	158	1006DL	93	1014AR	122
1810	136	3955	158	1006J	150	1014BB	128
1812	136	3960	158	1006TB	110	1014DL	93
1814	136	3965	158	1006TP	116	1014J	150
1816	136	5705	138	1006TR	104	1014TB	110
1901	158	5706	138	1006TW	99	1014TP	116
1902	158	5707	138	1007AR	122	1014TR	104
1903	158	5770	138	1007BB	128	1014TW	99
1904	158	5780	138	1007DL	93	1015AR	122
1905	158	5904	158	1007J	150	1015DL	93
1906	158	5975	158	1007TB	110	1015TB	110
1907	157	5980	158	1007TP	116	1015TP	116
1908	157	5990	158	1007TR	104	1015TR	104
1909	157	9007	234	1007TW	99	1015TW	99
1910	157	9154	158	1008AR	122	1016AR	122
1911	157	9752	139	1008BB	128	1016DL	93
1912	157	9952	158	1008DL	93	1016TB	110
1913	157	0001BB	133	1008J	150	1016TP	116
1914	157	0001J	155	1008TB	110	1016TR	104
1915	157	0002BB	133	1008TP	116	1016TW	99
1916	157	0002J	155	1008TR	104	102.8AR	126
1940	158	0010BB	130	1008TW	99	102.8BB	133
1945	158	0010J	152	1009AR	122	102.8DL	97
1960	158	0011BB	129	1009BB	128	102.8J	155
2308	152	0011J	152	1009DL	93	102.8TB	114
2309	152	0900BB	129	1009J	150	102.8TP	120
2311	152	0900J	152	1009TB	110	102.8TR	108
2404	137	0901BB	130	1009TP	116	102.8TW	102
2406	137	0901J	152	1009TR	104	1035BB	132
2408	137	0902BB	130	1009TW	99	1035J	155
2412	137	0902J	152	1010AR	122	1036BB	132
2414	137	0903BB	130	1010BB	128	1036J	155
2416	137	0903J	152	1010DL	93	1101AR	126
2907	157	1000CFB	186	1010J	150	1101DL	97
2908	157	1000CFG	186	1010TB	110	1101JBR	146
2909	157	1000CFR	186	1010TP	116	1101TB	114
2910	157	1002BB	133	1010TR	104	1101TP	120
2911	157	1002J	155	1010TW	99	1101TR	108
2912	157	1003AR	126	1012AR	122	1101TW	102
2913	157	1003DL	97	1012BB	128	1102AR	126
2914	157	1003TB	114	1012DL	93	1102DL	97
2916	157	1003TP	120	1012J	150	1102TB	114

# INDEX BY ITEM NUMBER

1  
to  
2

Item #	Page #
1102TP	120
1102TR	108
1102TW	102
1106AR	122
1106DL	93
1106TB	110
1106TP	116
1106TR	104
1106TW	99
1107AR	122
1107DL	93
1107TB	110
1107TP	116
1107TR	104
1107TW	99
1108AR	122
1108DL	93
1108TB	110
1108TP	116
1108TR	104
1108TW	99
1109AR	122
1109DL	93
1109TB	110
1109TP	116
1109TR	104
1109TW	99
1110AR	122
1110DL	93
1110TB	110
1110TP	116
1110TR	104
1110TW	99
1200CFB	186
1200CFG	186
1200CFR	186
1201BB	130
1201J	151
1202BB	130
1202J	151
1203BB	129
1203J	152
1206BB	128
1206J	150
1207BB	128
1207J	150
1208BB	128
1208J	150
1209BB	128
1209J	150
1210BB	128
1210J	150
1304BB	128
1304J	151
1305BB	128
1305J	151
1306BB	128

Item #	Page #
1306J	151
1307BB	128
1307J	151
1308BB	128
1308J	151
1338BB	133
1338J	155
1350BB	129
1350J	150
1360BB	129
1360J	150
1365BB	129
1365J	150
1400CFB	186
1400CFG	186
1400CFR	186
1501BB	129
1501J	151
1502BB	129
1502J	151
1503BB	129
1503J	152
1504BB	129
1504J	151
1505BB	129
1505J	151
1535BB	129
1535J	151
1600CFB	186
1600CFG	186
1600CFR	186
1607BB	130
1607J	152
1608BB	130
1608J	152
1609BB	130
1609J	152
1703TM	144
1704TM	144
1707TM	141
1708TM	141
1710TM	141
1712TM	141
1806TM	141
1807TM	141
1808TM	141
1809TM	141
1810TM	141
1812TM	141
1814TM	141
1816TM	141
19001BK	13
19001WT	21
19002BK	13
19002WT	21
1901GD	139
1901TM	144

Item #	Page #
1902TM	144
19035BK	13
19035WT	21
1903GD	138
1903TM	144
19045BK	13
19045WT	21
1904GD	138
1904TM	144
19055BK	13
19055WT	21
2008AR	123
2008BB	129
2008DL	94
2008J	151
2008TB	111
2008TP	117
2008TR	105
2008TW	100
2009AR	123
2009BB	129
2009DL	94
2009J	151
2009TB	111
2009TP	117
2009TR	105
2009TW	100
2010AR	123
2010BB	129
2010DL	94
2010J	151
2010TB	111
2010TP	117
2010TR	105
2010TW	100
2012AR	123
2012BB	129
2012DL	94
2012J	151
2012TB	111
2012TP	117
2012TR	105
2012TW	100
2014AR	123
2014DL	94
2014TB	111
2014TP	117
2014TR	105
2014TW	100
2016AR	123
2016DL	94
2016TB	111
2016TP	117
2016TR	105
2016TW	100
2109AR	123
2109DL	94

Item #	Page #
2109TB	111
2109TP	117
2109TR	105
2109TW	100
2110AR	123
2110DL	94
2110TB	111
2110TP	117
2110TR	105
2110TW	100
2112AR	123
2112DL	94
2112TB	111
2112TP	117
2112TR	105
2112TW	100
2113AR	123
2113DL	94
2113TB	111
2113TP	117
2113TR	105
2113TW	100
2114AR	123
2114DL	94
2114TB	111
2114TP	117
2114TR	105
2114TW	100
2308BB	130
2309BB	130
2311BB	130
24006BK	11
24006PR	15
24006WT	19
24007BK	11
24007PR	15
24007WT	19
24010BK	11
24010PR	15
24010WT	19
24012BK	11
24012PR	15
24012WT	19
2404TM	144
2406TM	142
2408TM	142
24110BK	13
24110PR	16
24110WT	21
2411TM	142
24120BK	11
24120PR	15
24120WT	19
2412TM	142
24140BK	11
24140PR	15
24140WT	19

## INDEX BY ITEM NUMBER

Item #	Page #
2414TM	142
2416TM	142
29004BK	11
29004PR	15
29004WT	19
29006BK	11
29006PR	15
29006WT	19
29007BK	11
29007PR	15
29007WT	19
29009BK	11
29009PR	15
29009WT	19
29010BK	11
29010PR	15
29010WT	19
29012BK	11
29012PR	15
29012WT	19
29110BK	13
29110PR	16
29110WT	21
29115BK	13
29115PR	16
29115WT	21
3001BB	132
3001J	155
3004AR	126
3004DL	97
3004TB	114
3004TP	120
3004TR	108
3004TW	102
3005BB	132
3005J	155
3006AR	126
3006BB	132
3006DL	97
3006J	155
3006TB	114
3006TP	120
3006TR	108
3006TW	102
3008AR	126
3008BB	132
3008DL	97
3008J	155
3008TB	114
3008TP	120
3008TR	108
3008TW	102
30-27	180
30-28	180
30-55	180
3201AR	125
3201BB	133

Item #	Page #
3201CAR	125
3201CBB	133
3201CDL	96
3201CJ	154
3201CTB	113
3201CTP	119
3201CTR	107
3201DL	96
3201J	154
3201TB	113
3201TP	119
3201TR	107
3221JBR	146
3222JBR	146
3223JBR	146
3501BB	
3501J	155
3502BB	133
3502J	154
3503BB	133
3503J	154
3504BB	133
3504J	154
3506BB	133
3506J	154
3540BB	132
3540J	154
3545BB	133
3545J	155
3601TM	144
3703TM	143
3704TM	143
3705TM	143
3706TM	143
3707TM	143
3708GD	137
3708TM	143
39045BK	12
39045PR	17
39045WT	20
39050BK	12
39050PR	17
39050WT	20
39055BK	12
39055PR	17
39055WT	20
39093BK	12
39093PR	17
39093WT	20
3955GD	139
3955TM	144
45-1	180
45-2	180
45-3	180
45-35	180
45-4	180
45-5	180

Item #	Page #
45-8	180
47128BK	13
47128PR	16
47128WT	21
49095BK	13
49095PR	16
49095WT	21
49136BK	13
49136PR	16
49136WT	21
49168BK	13
49168PR	16
49168WT	21
49208BK	13
49208PR	16
49208WT	21
5008BB	132
5008J	154
5008TB	113
5008TR	108
5060AR	124
5060BB	131
5060DL	95
5060J	153
5060TB	112
5060TP	118
5060TR	106
5065AR	124
5065BB	131
5065DL	95
5065J	153
5065TB	112
5065TP	118
5065TR	106
5070AR	124
5070BB	131
5070DL	95
5070J	153
5070TB	112
5070TP	118
5070TR	106
5075AR	124
5075BB	131
5075DL	95
5075J	153
5075TB	112
5075TP	118
5075TR	106
5085AR	124
5085BB	131
5085DL	95
5085J	153
5085TB	112
5085TP	118
5085TR	106
5095AR	124
5095BB	131

Item #	Page #
5095DL	95
5095J	153
5095TB	112
5095TP	118
5095TR	106
5106AR	125
5106BB	132
5106DL	96
5106J	154
5106TB	113
5106TP	119
5106TR	107
5106TW	101
5107AR	125
5107BB	132
5107DL	96
5107J	154
5107TB	113
5107TP	119
5107TR	107
5107TW	101
5108AR	125
5108BB	132
5108DL	96
5108J	154
5108TB	113
5108TR	107
5108TW	101
5185JBR	146
5206AR	124
5206BB	132
5206DL	95
5206J	153
5206TB	112
5206TP	118
5206TR	106
5206TW	101
5207AR	124
5207BB	132
5207DL	95
5207J	153
5207TB	112
5207TP	118
5207TR	106
5207TW	101
5208AR	124
5208BB	132
5208DL	95
5208J	153
5208TB	112
5208TP	118
5208TR	106
5208TW	101
5265AR	125
5265BB	131
5265DL	95

# INDEX BY ITEM NUMBER

5  
to  
7

Item #	Page #
5265J	154
5265TB	112
5265TP	118
5265TR	106
5265TW	101
5275AR	125
5275BB	131
5275DL	95
5275J	154
5275TB	112
5275TP	118
5275TR	106
5275TW	101
5285AR	125
5285BB	131
5285DL	95
5285J	154
5285TB	112
5285TP	118
5285TR	106
5285TW	101
5306AR	124
5306BB	131
5306DL	96
5306J	153
5306TB	113
5306TP	119
5306TR	107
5306TW	101
5307AR	124
5307BB	131
5307DL	96
5307J	153
5307TB	113
5307TP	119
5307TR	107
5307TW	101
5308AR	124
5308BB	131
5308DL	96
5308J	153
5308TB	113
5308TP	119
5308TR	107
5308TW	101
5309AR	124
5309BB	131
5309DL	96
5309J	153
5309TB	113
5309TP	119
5309TR	107
5309TW	101
5560JBR	146
5565JBR	146
5570JBR	146

Item #	Page #
5705TM	143
5706TM	143
5707TM	143
5765TM	143
5770TM	143
5780TM	143
62008BK	13
62008PR	17
62008WT	21
63010BK	13
63010PR	17
63010WT	21
6602GD	138
69003BK	12
69003PR	17
69003WT	20
69004BK	12
69004PR	17
69004WT	20
69005BK	12
69005PR	17
69005WT	20
69007BK	12
69007PR	17
69007WT	20
69008BK	12
69008PR	17
69008WT	20
69009BK	12
69009PR	17
69009WT	20
7000B	43
7000BL	76
7000G	31
7000R	39
7000V	35
7000W	51
7000Y	55
7001BB	134
7001BO	165
7001TL	164
7002BB	134
7002J	154
7002TP	120
7002TR	108
7003AR	126
7003B	114
7003BB	134
7003DL	97
7003GD	139
7003J	154
7003JBR	146
7003P	120
7003R	108
7003W	102
7004AR	126

Item #	Page #
7004TB	114
7004TP	120
7004TR	108
7005AR	126
7005B	114
7005BB	134
7005BO	165
7005DL	97
7005P	120
7005R	108
7005TL	164
7006BB	134
7006BO	165
7006TL	164
7007B	114
7007BB	134
7007BO	165
7007TL	164
7008BB	134
7008BO	165
7008TL	164
7009BB	134
7009BO	165
7009TL	164
7100J	154
7100JBR	146
7100TB	114
7100TR	108
7100TW	102
7200BK	13
7200JBR	146
7200PR	17
7200TW	102
7200WT	21
8004BB	134
8004J	155
8005BB	134
8005J	155
8006BB	134
8006J	155
8010AR	125
8010DL	96
8010TB	113
8010TP	119
8010TR	107
8011AR	125
8011DL	96
8011TB	113
8011TP	119
8011TR	107
9152AR	126
9152BB	133
9152DL	97
9152J	155
9152TB	114
9152TP	120

Item #	Page #
9152TR	108
9156TR	108
9302BB	133
9302J	155
9752TM	144
9753GD	139
9753TM	144
AD106AA	24
AD106WS	26
AD107AA	24
AD107WS	26
AD109AA	24
AD109WS	26
AD110AA	24
AD110WS	26
AD209AA	23
AD209WS	26
AD211AA	23
AD211WS	26
AD212AA	23
AD212WS	26
AD214AA	23
AD214WS	26
AD216AA	23
AD216WS	26
AD221AA	23
AD221WS	26
AD222AA	23
AD222WS	26
AD302AA	24
AD302WS	27
AD304WS	27
AD305AA	24
AD305WS	27
AD306AA	24
AD306WS	27
AD307AA	24
AD307WS	27
AD313WS	27
AD314WS	27
AD507AA	24
AD507WS	27
AD9016WS	27
AD908AA	24
AD908WS	27
AD918AA	24
AD918WS	27
ALBA0214	189
ALBA0312	189
ALBC007	286
ALBC008	286
ALBC009	28
ALBC010	286
ALBD006	286
ALBS001	169
ALBS002	169

## INDEX BY ITEM NUMBER

7  
to  
A

Item #	Page #	Item #	Page #	Item #	Page #	Item #	Page #
ALBS003	169	ALKAM010	195	ALPZ15	199	ALSKDB001	317
ALBS004	169	ALKAM020	195	ALPZ16	199	ALSKDB002	317
ALBS005	169	ALKAM040	195	ALPZ17	199	ALSKDB003	317
ALBS006	169	ALKMP012	189	ALPZ18	199	ALSKDB004	317
ALBS007	169	ALKMP024	189	ALPZ19	199	ALSKEFP001C	318
ALCP0302	194	ALMC001	196	ALPZ20	199	ALSKEFP002C	318
ALCP0303	194	ALMH001	295	ALPZ22	199	ALSKEFP003C	318
ALCP0602	194	ALMH002	295	ALRDH001	195	ALSKEFP004C	318
ALCP0603	194	ALMT002	295	ALRDH002	195	ALSKEFP005C	318
ALCP0802	194	ALMTW001	295	ALRNP013	201	ALSKEFP101C	318
ALCP0803	194	ALPC001	174	ALRNP015	201	ALSKEFP102C	318
ALCP0902	194	ALPC002	174	ALRNP018	201	ALSKEFP103C	318
ALCP0903	194	ALPG008H	200	ALRP9603	315	ALSKEFP104C	318
ALCP1002	194	ALPMA005	193	ALRP9604	315	ALSKEFP105C	318
ALCP1003	194	ALPMA006	193	ALRP9605	315	ALSKPC005	315
ALCP1004	194	ALPMA007	193	ALSAP001	314	ALSKPC112	315
ALCP1202	194	ALPMA008	193	ALSAP002	314	ALSKPC120	315
ALCP1203	194	ALPMA009	193	ALSAP003	314	ALSKSP001	312
ALCP1204	194	ALPMA010	193	ALSAP004	314	ALSKSP002	312
ALCP1402	194	ALPMA012	193	ALSAP101	314	ALSKSP003	312
ALCP1403	194	ALPN009	193	ALSAP102	314	ALSKSP004	312
ALCP1404	194	ALPN010	193	ALSAP103	314	ALSKSP005	312
ALCP1602	194	ALPN011	193	ALSAP104	314	ALSKSP006	312
ALCP1603	194	ALPN012	193	ALSB001	169	ALSKSP007	312
ALCP1604	194	ALPTCS008	199	ALSB002	169	ALSKSP008	312
ALDCS006	334	ALPTCS009	199	ALSB003	169	ALSKSP009	312
ALDN2036	274	ALPTCS010	199	ALSB004	169	ALSKSP010	312
ALDN2036E	274	ALPTCS011	199	ALSB005	169	ALSKSP011	312
ALDN2048	274	ALPTCS012	199	ALSB006	169	ALSKSP012	312
ALDN2048E	274	ALPTCS013	199	ALSB007	169	ALSKSP013	312
ALDN2060	274	ALPTCS014	199	ALSB008	169	ALSKSP014	312
ALDN2060E	274	ALPTCS015	199	ALSB009	169	ALSKSP015	312
ALDP048	193	ALPTCS016	199	ALSC1826	191	ALSKSP101	312
ALDP048C	193	ALPTCS017	199	ALSF001	316	ALSKSP102	312
ALDP096	193	ALPTCS018	199	ALSF002	316	ALSKSP103	312
ALDP096C	193	ALPTWR008	199	ALSF003	316	ALSKSP104	312
ALDT045	330	ALPTWR009	199	ALSH001	364	ALSKSP105	312
ALDT060	330	ALPTWR010	199	ALSH001EP	364	ALSKSP106	312
ALES-005C	253	ALPTWR011	199	ALSKAC001	300	ALSKSP107	312
ALES005R	253	ALPTWR012	199	ALSKAC002	300	ALSKSP108	312
ALFN001	364	ALPTWR013	199	ALSKBK002	313	ALSKSP109	312
ALFP001	364	ALPTWR014	199	ALSKBK003	313	ALSKSP110	312
ALFP002	364	ALPTWR015	199	ALSKBK005	313	ALSKSP111	312
ALFPEX001C	318	ALPTWR016	199	ALSKBK006	313	ALSKSP112	312
ALFPEX002C	318	ALPTWR017	199	ALSKBK007	313	ALSKSP113	312
ALFPEX003C	318	ALPTWR018	199	ALSKBK008	313	ALSKSP114	312
ALFPEX004C	318	ALPTWR019	199	ALSKBK010	313	ALSKSP115	312
ALFPEX005C	318	ALPTWR020	199	ALSKBK012	313	ALSKSP601	313
ALHDCO001	300	ALPTWR022	199	ALSKBP001	315	ALSKSP602	313
ALHDCO002	300	ALPZ08	199	ALSKBP002	315	ALSKSP603	313
ALHDCO003	300	ALPZ09	199	ALSKBP003	315	ALSKSP604	313
ALHDCO101	300	ALPZ10	199	ALSKBP004	315	ALSKSP605	313
ALHDCO102	300	ALPZ11	199	ALSKBP005	315	ALSKSP606	313
ALHP004A	295	ALPZ12	199	ALSKBP006	315	ALSKSP607	313
ALJM001	307	ALPZ13	199	ALSKBP007	315	ALSKSP608	313
ALKAM005	195	ALPZ14	199	ALSKBP008	315	ALSKSP609	313

# INDEX BY ITEM NUMBER

A  
to  
C

Item #	Page #	Item #	Page #	Item #	Page #	Item #	Page #
ALSKSP610	313	ALSS010AC	317	ASPS325	332	CMEP2172	363
ALSKSP611	313	ALSS030AC	317	ASPS330	332	CMEP2424	363
ALSKSS001	316	ALSS050AC	317	BACS002	187	CMEP2430	363
ALSKSS002	316	ALST001	177	BANP001	168	CMEP2436	363
ALSKSS003	316	ALST002	177	BANP002	168	CMEP2442	363
ALSKSS004	316	ALST003	177	BASR095JP	187	CMEP2448	363
ALSKSS005	316	ALST004	177	BASR195JP	187	CMEP2454	363
ALSKSS006	316	ALST005	177	BAST006	169	CMEP2460	363
ALSKSS007	316	ALST006	177	BAST008	169	CMEP2472	363
ALSKSS008	316	ALST007	177	BAST010	169	CMPC008	362
ALSKSS101	316	ALST008	177	BAST012	169	CMPC034	362
ALSKSS102	316	ALST010	177	BATP001	183	CMPC063	362
ALSKSS103	316	ALST011	177	CETW001	176	CMPC072	362
ALSKSS104	316	ALST012	177	CETW002	176	CMPC086	362
ALSKSS105	316	ALST013	177	CETW003	176	CMSV1424	362
ALSKSS106	316	ALST014	177	CETW004	176	CMSV1430	362
ALSKSS107	316	ALST015	177	CETW005	176	CMSV1436	362
ALSKSS108	316	ALST016	177	CLRC001	256	CMSV1448	362
ALSKSU005	314	ALTBCR001G	334	CMCH014	365	CMSV1460	362
ALSKSU008	314	ALTBCR111A	334	CMCH018	365	CMSV1472	362
ALSKSU014	314	ALTWFC004	283	CMCH021	365	CMSV1824	362
ALSKSU020	314	ALTWFC007	283	CMCH024	365	CMSV1830	362
ALSKSU026	314	ALTWFC016	283	CMDC014	365	CMSV1836	362
ALSKSU036	314	ALTWSC005	283	CMDC018	365	CMSV1842	362
ALSKSU040	314	ALTWSC012	283	CMDC021	365	CMSV1848	362
ALSKSU060	314	ALTWSC024	283	CMDC024	365	CMSV1854	362
ALSKSU105	314	ALTWSC038	283	CMDE014	365	CMSV1860	362
ALSKSU108	314	ALTWSC058	283	CMDE018	365	CMSV1872	362
ALSKSU114	314	ALTWSC085	283	CMDE021	365	CMSV2124	362
ALSKSU120	314	ALWDPP2512	200	CMDE024	365	CMSV2130	362
ALSKSU126	314	ALWDPP3012	200	CMEC008	363	CMSV2136	362
ALSKSU136	314	ALWDPP3512	200	CMEC034	363	CMSV2142	362
ALSKSU140	314	ALWDPP5212	200	CMEC063	363	CMSV2148	362
ALSKSU160	314	ALWP001	236	CMEC072	363	CMSV2154	362
ALSKTP012	317	APLG022	332	CMEC086	363	CMSV2160	362
ALSP002	176	APLG022D	332	CMEP1424	363	CMSV2172	362
ALSP003	176	APLG025	332	CMEP1430	363	CMSV2424	362
ALSP004	176	APLG025D	332	CMEP1436	363	CMSV2430	362
ALSP1006	190	APPG022	332	CMEP1448	363	CMSV2436	362
ALSP1013	190	APPG022D	332	CMEP1460	363	CMSV2442	362
ALSP1622	190	APPG025	332	CMEP1472	363	CMSV2448	362
ALSP1813	190	APPG025D	332	CMEP1824	363	CMSV2454	362
ALSP1813D	190	ASCS019BT	333	CMEP1830	363	CMSV2460	362
ALSP1813PF	190	ASCS112	333	CMEP1836	363	CMSV2472	362
ALSP1813PG	190	ASCS115	333	CMEP1842	363	CR005BU	41
ALSP1826	190	ASCS119	333	CMEP1848	363	CR005GR	29
ALSP1826D	190	ASGD057	333	CMEP1854	363	CR005PR	45
ALSP1826H	190	ASLG322	332	CMEP1860	363	CR005RD	37
ALSP1826HPF	190	ASLG325	332	CMEP1872	363	CR005V	33
ALSP1826M	190	ASLG330	332	CMEP2124	363	CR005W	49
ALSP1826PF	190	ASLS325	332	CMEP2130	363	CR005YW	53
ALSP1826PG	190	ASLS330	332	CMEP2136	363	CR006BU	41
ALSP1826S	190	ASPG319	332	CMEP2142	363	CR006GR	29
ALSPR010	192	ASPG322	332	CMEP2148	363	CR006PR	45
ALSPR020	192	ASPG325	332	CMEP2154	363	CR006RD	37
ALSR001	174	ASPG330		CMEP2160	363	CR006V	33





# INDEX BY ITEM NUMBER

Item #	Page #	Item #	Page #	Item #	Page #	Item #	Page #
CR006W	49	CR110W	50	CR5077W	50	CR5810W	50
CR006YW	53	CR110YW	54	CR5077YW	54	CR5810YW	54
CR007BU	41	CR209BU	41	CR5510BU	43	CR5811BU	42
CR007GR	29	CR209GR	29	CR5510GR	31	CR5811GR	30
CR007PR	45	CR209PR	45	CR5510PR	47	CR5811PR	46
CR007RD	37	CR209RD	37	CR5510RD	39	CR5811RD	38
CR007V	33	CR209V	33	CR5510V	35	CR5811V	34
CR007W	49	CR209W	49	CR5510W	51	CR5811W	50
CR007YW	53	CR209YW	53	CR5510YW	55	CR5811YW	54
CR009BU	41	CR212BU	41	CR5608BU	42	CR710BU	41
CR009GR	29	CR212GR	29	CR5608GR	30	CR710GR	29
CR009PR	45	CR212PR	45	CR5608PR	46	CR710PR	45
CR009RD	37	CR212RD	37	CR5608RD	38	CR710RD	37
CR009V	33	CR212V	33	CR5608V	34	CR710V	33
CR009W	49	CR212W	49	CR5608W	50	CR710W	49
CR009YW	53	CR212YW	53	CR5608YW	54	CR710YW	53
CR010BU	41	CR213BU	41	CR5712BU	43	CR804BK	12
CR010GR	29	CR213GR	29	CR5712GR	31	CR804PR	46
CR010PR	45	CR213PR	45	CR5712PR	47	CR804W	20
CR010RD	37	CR213RD	37	CR5712RD	39	CR804YW	54
CR010V	33	CR213V	33	CR5712V	35	CR805BK	12
CR010W	49	CR213W	49	CR5712W	51	CR805PR	46
CR010YW	53	CR213YW	53	CR5712YW	55	CR805W	20
CR012BU	41	CR303BU	43	CR5716BU	42	CR805YW	54
CR012GR	29	CR303GR	31	CR5716GR	30	CR806BK	12
CR012PR	45	CR303PR	47	CR5716PR	46	CR806PR	46
CR012RD	37	CR303RD	39	CR5716RD	38	CR806W	20
CR012V	33	CR303V	35	CR5716V	34	CR806YW	54
CR012W	49	CR303W	51	CR5716W	50	CR807BK	12
CR012YW	53	CR303YW	55	CR5716YW	54	CR807PR	46
CR106BU	42	CR305BU	43	CR5804BU	43	CR807W	20
CR106GR	30	CR305GR	31	CR5804GR	31	CR807YW	54
CR106PR	46	CR305PR	47	CR5804PR	47	CR9010BU	43
CR106RD	38	CR305RD	39	CR5804RD	39	CR9010GR	31
CR106V	34	CR305V	35	CR5804V	35	CR9010PR	47
CR106W	50	CR305W	51	CR5804W	51	CR9010RD	39
CR106YW	54	CR305YW	55	CR5804YW	55	CR9010V	35
CR107BU	42	CR313BU	43	CR5807BU	43	CR9010W	51
CR107GR	30	CR313GR	31	CR5807GR	31	CR9010YW	55
CR107PR	46	CR313PR	47	CR5807PR	47	CR9016BU	43
CR107RD	38	CR313RD	39	CR5807RD	39	CR9016GR	31
CR107V	34	CR313V	35	CR5807V	35	CR9016PR	47
CR107W	50	CR313W	51	CR5807W	51	CR9016RD	39
CR107YW	54	CR313YW	55	CR5807YW	55	CR9016V	35
CR109BU	42	CR5044BU	43	CR5809BU	42	CR9016W	51
CR109GR	30	CR5044GR	31	CR5809GR	30	CR9016YW	55
CR109PR	46	CR5044PR	47	CR5809PR	46	CR9018BU	43
CR109RD	38	CR5044RD	39	CR5809RD	38	CR9018GR	31
CR109V	34	CR5044V	35	CR5809V	34	CR9018PR	47
CR109W	50	CR5044W	51	CR5809W	50	CR9018RD	39
CR109YW	54	CR5044YW	55	CR5809YW	54	CR9018V	35
CR110BU	42	CR5077BU	42	CR5810BU	42	CR9018W	51
CR110GR	30	CR5077GR	30	CR5810GR	30	CR9018YW	55
CR110PR	46	CR5077PR	46	CR5810PR	46	CR9035BU	43
CR110RD	38	CR5077RD	38	CR5810R	38	CR9035GR	31
CR110V	34	CR5077V	34	CR5810V	34	CR9035PR	47

C

# INDEX BY ITEM NUMBER

C  
to  
M

Item #	Page #
CR9035RD	39
CR9035V	35
CR9035W	51
CR9035YW	55
CR9108BU	43
CR9108GR	31
CR9108PR	47
CR9108RD	39
CR9108V	35
CR9108W	51
CR9108YW	55
CR9303BU	43
CR9303GR	31
CR9303PR	47
CR9303RD	39
CR9303V	35
CR9303W	51
CR9303YW	55
CRCCT038	201
CRDB1218	254
CRDB1626	254
CRHH876	254
CRPT1015	252
CRPTS997	327
CRSP435	322
CRSP956	322
CRTCH008	322
CRTCH012	322
CRTCH014	322
CRTCH018	322
CRTSCD3812	268
DM005H	65
DM005J	70
DM006H	65
DM006J	70
DM007H	65
DM007J	70
DM009H	65
DM009J	70
DM010H	65
DM010J	70
DM012H	65
DM012J	70
DM209H	65
DM209J	70
DM212H	65
DM212J	70
DM213H	65
DM213J	70
DM5044H	65
DM5044J	70
DM5608H	65
DM5608J	70
DM5807H	65
DM5807J	70
DM5811H	65

Item #	Page #
DM5811J	70
GLCJ007	322
GLTWCC005	320
GLTWCC205	320
GLTWCS006	320
GLTWCS006P	320
GLTWOC006	321
GLTWOC206	321
GLTWPS001	320
GLTWPS002	320
GLTWSJ012	321
GLTWSJ012H	321
GLTWSJ012P	321
GLTWSS002	320
GLTWSS003	320
GLTWSY006	321
GLTWSY014	321
GLTWTS001	320
GLTWTS201	320
GN001	253
GN1001W	167
GN1002W	167
GN1004W	167
GN1121W	167
GN1122W	167
GN1124W	167
GN1132W	167
GN1134W	167
GN1142W	167
GN1144W	167
GN1162W	167
GN1164W	167
GN1221W	167
GN1222W	167
GN1232W	167
H-205	179
HL-22	186
HL-23	186
HL36-2	186
HPCS008	170
IRBB001	344
IRBB002	344
IRBN001L	178
IRBN001N	178
IRBN002L	178
IRBN002N	178
IRBN003N	178
IRBR001L	178
IRBR001N	178
IRBR002CL	178
IRBR002CN	178
IRBR002L	178
IRBR002N	178
IRBR003CL	178
IRBR003CN	178
IRBR003L	178

Item #	Page #
IRBR003N	178
IRBR004CL	178
IRBR004CN	178
IRBR004L	178
IRBR004N	178
IRCP008	212
IRFFC001	280
IRFFC001B	280
IRFFC001W	280
IRFFC002	280
IRFFC002B	280
IRFFC002W	280
IRFFC003	280
IRFFC003B	280
IRFFC003W	280
IRFFC004	280
IRFFC004B	280
IRFFC004W	280
IRFFC005	280
IRFFC005B	280
IRFFC005W	280
IRFFC009H	280
IRFFC104	280
IRFS001	179
IRFS002	179
IRFS003	179
IRFS004	179
IRJM001	307
IRJWC001	175
IRJWC002	175
IRJWC301	175
IRJWC302	175
IRPA001	182
IRPA002	182
IRPA003	182
IRPA004	182
IRPC008	212
IRSC001	234
IRSH4403	211
IRSK795	343
IRSP1107	344
IRSP1108	344
IRTC014	306
IRTISH200	261
IRTISH300	261
IRTISH400	261
IRTP001	176
IRTP002	176
IRWC001	174
IRWC002	174
IRWC003	174
IRWC004	174
IRWC005	174
IRWC006	175
IRWC007	175
IRWK001	175

Item #	Page #
IRWK002	175
JAS010055A	172
JAS010055B	172
JAS012180	171
JAS012210	171
JAS012240	171
JAS012270	171
JAS012300	171
JAS012330	171
JAS013001	171
JAS013002	171
JAS013003	171
JAS013090	171
JAS014210	171
JAS014240	171
JAS014270	171
JAS014300	171
JAS022006	234
JPRB001	181
JPRB002	181
K109	183
ML350B1	160
ML351B1	160
ML351BL1	162
ML351C1	161
ML351CB1	161
ML351W1	160
ML352B1	160
ML352BL1	162
ML352C1	161
ML352CB1	161
ML352W1	160
ML507B1	160
ML507B1R	163
ML507BL1	162
ML507C1	161
ML507CB1	161
ML507W1	160
ML507W1R	163
ML509B1	160
ML509B1R	163
ML509BL1	162
ML509C1	161
ML509CB1	161
ML509W1	160
ML509W1R	163
ML531B1	160
ML531B1R	163
ML531BL1	162
ML531C1	161
ML531CB1	161
ML531W1	160
ML531W1R	163
ML532B1	160
ML532B1R	163
ML532BL1	162

# INDEX BY ITEM NUMBER

Item #	Page #
ML532C1	161
ML532CB1	161
ML532W1	160
ML532W1R	163
ML533B1	160
ML533BL1	162
ML533C1	161
ML533CB1	161
ML533W1	160
ML534B1	160
ML534BL1	162
ML534C1	161
ML534CB1	161
ML534W1	160
ML535B1	160
ML535B1R	163
ML535BL1	162
ML535C1	161
ML535CB1	161
ML535W1	160
ML535W1R	163
ML536B1	160
ML536B1R	163
ML536BL1	162
ML536BU1	43
ML536C1	161
ML536CB1	161
ML536GR1	31
ML536PR1	47
ML536RD1	39
ML536W1	160
ML536W1R	163
ML536YW1	55
ML537B1	160
ML537B1R	163
ML537BL1	162
ML537C1	161
ML537CB1	161
ML537W1	160
ML537W1R	163
ML538B1	160
ML538B1R	163
ML538BL1	162
ML538BU1	43
ML538C1	161
ML538CB1	161
ML538GR1	31
ML538PR1	47
ML538RD1	39
ML538W1	160
ML538W1R	163
ML538YW1	55
ML539B1	160
ML539BL1	162
ML539C1	161
ML539CB1	161

Item #	Page #
ML539W1	160
ML801S	336
ML802S	336
ML803T	336
ML803W	336
ML9011I	35
ML9011PR	47
ML9011T	59
ML9011W	51
ML901I	35
ML901S	59
ML901T	59
ML901W	63
MLCS001	187
MLCS001B	187
MLCS001G	187
MLCS002	187
MRGR001	168
MRGR002	168
MRGR003	168
MRWC001R	210
MRWC002R	210
N-901PR	47
NS105T	57
NS105W	61
NS106T	57
NS106W	61
NS107T	57
NS107W	61
NS108T	57
NS108W	61
NS109T	57
NS109W	61
NS110T	57
NS110W	61
NS209T	58
NS209W	62
NS211T	58
NS211W	62
NS212T	58
NS212W	62
NS215T	58
NS215W	62
NS302T	59
NS302W	63
NS303T	59
NS303W	63
NS304T	59
NS304W	63
NS305T	59
NS305W	63
NS306T	59
NS306W	63
NS307T	59
NS307W	63
NS314T	59

Item #	Page #
NS314W	63
NS315T	59
NS315W	63
NS502T	59
NS502W	63
NS503T	59
NS503W	63
NS5060T	59
NS5060W	63
NS5065T	59
NS5065W	63
NS5070T	59
NS5070W	63
NS5075T	59
NS5075W	63
NS5085T	59
NS5085W	63
NS5095T	59
NS5095W	63
NS510T	58
NS510W	62
NS512T	58
NS512W	62
NS513T	58
NS513W	62
NS515T	58
NS515W	62
NS516T	58
NS516W	62
NS608-1R	57
NS608-1T	57
NS608-1W	61
NS608CR	57
NS608CT	57
NS608CW	61
NS608R	57
NS608T	57
NS608W	61
NS701T	57
NS701W	61
NS702T	57
NS702W	61
NS703T	57
NS703W	61
OW110	209
OW115	209
OW189	173
OW356	196
OW358	282
OW360	234
OW362	302
OW364	298
P-222	185
PATSC050	268
PCPC-1BL	325
PCPC-1BR	325

Item #	Page #
PH5005TW	185
PH5005V	185
PH5007TW	185
PH5007V	185
PH5008TW	185
PH5008V	185
PH5010TW	185
PH5010V	185
PL351BL1	162
PL352BL1	162
PL507BL1	162
PL509BL1	162
PL531BL1	162
PL532BL1	162
PL533BL1	162
PL534BL1	162
PL535BL1	162
PL536BL1	162
PL537BL1	162
PL538BL1	162
PL539BL1	162
PLA013	181
PLA016	181
PLBB008C	305
PLBB008M	305
PLBB010C	305
PLBB010M	305
PLBB012C	305
PLBB012M	305
PLBB1107	338
PLBB1209	338
PLBB825	338
PLBB825G	338
PLBB850	338
PLBB850G	338
PLBB900	338
PLBB900G	338
PLBC0012B	273
PLBC0013B	273
PLBC004P	210
PLBC006	212
PLBC3316B	273
PLBC3316G	273
PLBC4019B	273
PLBC4019G	273
PLBD006PP	248
PLBK008B	339
PLBK008G	339
PLBK008K	339
PLBK008R	339
PLBK008Y	339
PLBK1034B	339
PLBK1034G	339
PLBK1034K	339
PLBK1034R	339
PLBK1034Y	339

M  
to  
P

# INDEX BY ITEM NUMBER

**P**

Item #	Page #
PLBK912G	339
PLBK938B	339
PLBK938G	339
PLBK938K	339
PLBK938R	339
PLBK938Y	339
PLBL240C	215
PLBL240G	215
PLBL240K	215
PLBL240R	215
PLBL240W	215
PLBM001S	197
PLBM002S	197
PLBM003S	197
PLBM004S	197
PLBM005S	197
PLBM006S	198
PLBM007S	198
PLBM008S	198
PLBM009S	198
PLBM010S	198
PLBM027BL	214
PLBM027R	214
PLBM0804S	198
PLBM1108S	198
PLBM1216S	198
PLBM1520S	198
PLBM1624S	198
PLBN1208T	338
PLBN1313T	338
PLBN1410T	338
PLBN1611T	338
PLBN1712T	338
PLBN1813T	338
PLBS010BG	290
PLBS010BK	290
PLBS010CL	290
PLBS010GR	290
PLBS010RD	290
PLBS010WH	290
PLBS110BG	290
PLBS110BK	290
PLBS110CL	290
PLBS110GR	290
PLBS110RD	290
PLBS110WH	290
PLBT002W	272
PLBT005B	272
PLBT005G	272
PLBT005W	272
PLBT007B	272
PLBT007G	272
PLBT007W	272
PLBT505BPF	272
PLBT505GPF	272
PLBT505WPF	272
PLBTC001B	272

Item #	Page #
PLBTC001G	272
PLBTC001W	272
PLBTC002W	272
PLCB001	250
PLCB002	250
PLCB003	250
PLCB004	250
PLCB005	250
PLCB006	250
PLCB007	250
PLCB008	250
PLCB011	250
PLCB012	250
PLCB013	250
PLCB014	250
PLCB015	250
PLCB016	250
PLCB017	250
PLCB181205BR	251
PLCB181205BU	251
PLCB181205GR	251
PLCB181205MX	251
PLCB181205PP	251
PLCB181205RD	251
PLCB181205WH	251
PLCB181205YW	251
PLCB201505BR	251
PLCB201505BU	251
PLCB201505GR	251
PLCB201505MX	251
PLCB201505PP	251
PLCB201505RD	251
PLCB201505WH	251
PLCB201505YW	251
PLCB241805BR	251
PLCB241805BU	251
PLCB241805GR	251
PLCB241805MX	251
PLCB241805PP	251
PLCB241805RD	251
PLCB241805WH	251
PLCB241805YW	251
PLCB3140	364
PLCB3140B	364
PLCB3150	249
PLCB3150B	249
PLCB4140	273
PLCB4140B	273
PLCB5140	364
PLCB5140B	364
PLCB5150	191
PLCBB02BR	252
PLCBB02BU	252
PLCBB02GR	252
PLCBB02RD	252
PLCBB02WH	252
PLCBB02YW	252

Item #	Page #
PLCBR006	252
PLCD064	331
PLCD064D	331
PLCDB001	331
PLCH001-B	187
PLCH001-I	187
PLCJ007	322
PLCJ007C	322
PLCS001	187
PLCS002	187
PLCS003	187
PLDB003	274
PLDB004	274
PLDB005	274
PLDB006	274
PLDB007	274
PLDB182603PP	248
PLDB182606PP	248
PLDBC1826PP	248
PLDC001	335
PLDC002	335
PLDCT001	335
PLDLF001	364
PLDP002	269
PLDP003	269
PLDP345	269
PLDS005B	339
PLDS005C	339
PLDS005K	339
PLDS005P	339
PLFA006	248
PLFB001	301
PLFB002	301
PLFB003	301
PLFB004	301
PLFB005	301
PLFB121803PC	246
PLFB121803PP	247
PLFB121806PC	246
PLFB121806PP	247
PLFB121809PC	246
PLFB121809PP	247
PLFB182603PC	246
PLFB182603PP	247
PLFB182606PC	246
PLFB182606PP	247
PLFB182609PC	246
PLFB182609PP	247
PLFB182612PC	246
PLFB182612PP	247
PLFB182615PC	246
PLFB182615PP	247
PLFBC1218PC	246
PLFBC1218PP	247
PLFBC1826PC	246
PLFBC1826PP	247
PLFBD1218PC	246

Item #	Page #
PLFBD1218PP	247
PLFBD1826PC	246
PLFBD1826PP	247
PLFC001	231
PLFCCB001	274
PLFCCB001B	274
PLFCS330	270
PLFCS332	270
PLFDS285	273
PLFFFT1014BK	335
PLFFFT1014BR	335
PLFFFT1014GR	335
PLFFFT1014RD	335
PLFFFT1014RR	335
PLFFFT1216BK	335
PLFFFT1216BR	335
PLFFFT1216GR	335
PLFFFT1216RD	335
PLFFFT1216RR	335
PLFFFT1418BK	335
PLFFFT1418BR	335
PLFFFT1418GR	335
PLFFFT1418RD	335
PLFFFT1418RR	335
PLFL330	270
PLFN004	235
PLFN005	235
PLFN006	235
PLFP001	301
PLFT1100BK	221
PLFT1100BR	221
PLFT1400BK	221
PLFT1400BR	221
PLFT1418BK	221
PLFT1418BR	221
PLFT1600BK	221
PLFT1600BR	221
PLFT2700BK	221
PLFT2700BR	221
PLFTD395	268
PLFTG006BG	291
PLFTG006BK	291
PLFTG006CL	291
PLFTG006GR	291
PLFTG006RD	291
PLFTG006WH	291
PLFTG009BG	291
PLFTG009BK	291
PLFTG009CL	291
PLFTG009GR	291
PLFTG009RD	291
PLFTG009WH	291
PLFTG012BG	291
PLFTG012BK	291
PLFTG012CL	291
PLFTG012GR	291
PLFTG012RD	291

## INDEX BY ITEM NUMBER

Item #	Page #	Item #	Page #	Item #	Page #	Item #	Page #
PLFTG012WH	291	PLIS9321BK	361	PLMENU-L4BR	324	PLPA7140CBK	245
PLGL001	270	PLIS9322BK	361	PLMENU-L4GR	324	PLPA7140CS	243
PLGL002	270	PLIS9323BK	361	PLMENU-L4MA	324	PLPA7140CSBK	245
PLGL003	270	PLIS9324BK	361	PLMH001	323	PLPA7140DS	243
PLGL004	270	PLIS9325BK	361	PLMH002	323	PLPA7140DSBK	245
PLGL004BU	270	PLIS9326BK	361	PLMH003	323	PLPA7160C	243
PLGL004GR	270	PLIS9327BK	361	PLMH004	323	PLPA7160CBK	245
PLIB002S	249	PLIS9328BK	361	PLMJ004BK	336	PLPA7160CS	243
PLIB005S	249	PLIS9329BK	361	PLMJ010BK	336	PLPA7160CSBK	245
PLIB010S	249	PLIS9330BK	361	PLMJ056BK	336	PLPA7160DS	243
PLIB021C	249	PLIS9331BK	361	PLML008N	211	PLPA7160DSBK	245
PLIB027C	249	PLIS9332BK	361	PLML008T	211	PLPA7190C	243
PLIM1212SM	214	PLIS9333BK	361	PLNB001	180	PLPA7190CBK	245
PLIS6901BK	358	PLIS9334BK	361	PLNB002	180	PLPA7190CS	243
PLIS6902BK	358	PLIS9335BK	361	PLNP001	275	PLPA7190CSBK	245
PLIS6903BL	358	PLIS9336BK	361	PLNP002	275	PLPA8002	242
PLIS6904RD	358	PLIS9337BK	361	PLOP009BG	288	PLPA8002BK	244
PLIS6905RD	358	PLIS9338BK	361	PLOP009BK	288	PLPA8004	242
PLIS6906RD	358	PLIS9339BK	361	PLOP009CL	288	PLPA8004BK	244
PLIS6907RD	358	PLIS9340BK	361	PLOP009GR	288	PLPA8006	242
PLIS6908BK	358	PLIS9341BK	361	PLOP009RD	288	PLPA8006BK	244
PLIS6909BL	358	PLIS9601BK	359	PLOP009WH	288	PLPA8008	242
PLIS6910RD	358	PLKB001	331	PLOP010BG	288	PLPA8008BK	244
PLIS6911BL	358	PLMC008CL	256	PLOP010BK	288	PLPA8122	242
PLIS6912BK	358	PLMC016CL	256	PLOP010CL	288	PLPA8122BK	244
PLIS6913RD	358	PLMC032CL	256	PLOP010GR	288	PLPA8122L	242
PLIS6914BL	358	PLMC064CL	256	PLOP010RD	288	PLPA8122LBK	244
PLIS6951BK	359	PLMC128CL	256	PLOP010WH	288	PLPA8124	242
PLIS6952BK	359	PLMD008CL	256	PLOP013BG	288	PLPA8124BK	244
PLIS6953BK	359	PLMD016CL	256	PLOP013BK	288	PLPA8124L	242
PLIS6954BK	359	PLMD032CL	256	PLOP013CL	288	PLPA8124LBK	244
PLIS6955BK	359	PLMD064CL	256	PLOP013GR	288	PLPA8126	242
PLIS6956BK	359	PLMD128CL	256	PLOP013RD	288	PLPA8126BK	244
PLIS6957BL	359	PLMENU-1BL	325	PLOP013WH	288	PLPA8128	242
PLIS6958BL	359	PLMENU-1BR	325	PLPA7000C	243	PLPA8128BK	244
PLIS6959BL	359	PLMENU-1GR	325	PLPA7000CBK	245	PLPA8132	242
PLIS6960BL	359	PLMENU-1MA	325	PLPA7000CS	243	PLPA8132BK	244
PLIS9301BK	360	PLMENU-2BL	325	PLPA7000CSBK	245	PLPA8134	242
PLIS9302BK	360	PLMENU-2BR	325	PLPA7000DS	243	PLPA8134BK	244
PLIS9303BK	360	PLMENU-2GR	325	PLPA7000DSBK	245	PLPA8136	242
PLIS9304BK	360	PLMENU-2MA	325	PLPA7120C	243	PLPA8136BK	244
PLIS9305BK	360	PLMENU-3BL	325	PLPA7120CBK	245	PLPA8138	242
PLIS9306BK	360	PLMENU-3BR	325	PLPA7120CS	243	PLPA8138BK	244
PLIS9307RD	360	PLMENU-3GR	325	PLPA7120CSBK	245	PLPA8142	242
PLIS9308BK	360	PLMENU-3MA	325	PLPA7120DS	243	PLPA8142BK	244
PLIS9309BK	360	PLMENU-4	324	PLPA7120DSBK	245	PLPA8144	244
PLIS9310BK	360	PLMENU-4BR	324	PLPA7120LC	243	PLPA8144BK	244
PLIS9311BK	360	PLMENU-6BL	324	PLPA7120LCBK	245	PLPA8146	242
PLIS9312BK	360	PLMENU-6BR	324	PLPA7120LDS	243	PLPA8146BK	244
PLIS9313BK	360	PLMENU-6GR	324	PLPA7120LDSBK	245	PLPA8162	242
PLIS9314BK	360	PLMENU-6MA	324	PLPA7130C	243	PLPA8162BK	244
PLIS9315BK	360	PLMENU-6TGI	324	PLPA7130CBK	245	PLPA8164	242
PLIS9316RD	360	PLMENU-L3BL	324	PLPA7130CS	243	PLPA8164BK	244
PLIS9317BK	360	PLMENU-L3BR	324	PLPA7130CSBK	245	PLPA8166	242
PLIS9318BK	360	PLMENU-L3GR	324	PLPA7130DS	243	PLPA8166BK	244
PLIS9319BK	360	PLMENU-L3MA	324	PLPA7130DSBK	245	PLPA8192	242
PLIS9320BK	360	PLMENU-L4BL	324	PLPA7140C	243	PLPA8192BK	244

# INDEX BY ITEM NUMBER

P

Item #	Page #	Item #	Page #	Item #	Page #	Item #	Page #
PLPA8194	242	PLPCTB320RD	340	PLPR900WH	219	PLRPS5	364
PLPA8194BK	244	PLPCTB324BL	340	PLPR900YW	219	PLRS001	185
PLPB018	200	PLPCTB324CL	340	PLPRC001	217	PLRS003	185
PLPB020	200	PLPCTB324GR	340	PLPRC002BK	217	PLRSB064	275
PLPB024	200	PLPCTB324RD	340	PLPRC002RD	217	PLRT012	220
PLPCM001	203	PLPP001BK	285	PLPRC020	192	PLRT012BCK	220
PLPCTB108BL	341	PLPP002BK	285	PLPT046BL	326	PLRT012CK	220
PLPCTB108CL	341	PLPP003BK	285	PLPT046BR	326	PLRT014	220
PLPCTB108GR	341	PLPP004BK	285	PLPTB016A	342	PLRT014BCK	220
PLPCTB108RD	341	PLPP005BK	285	PLPTB016C	342	PLRT014CK	220
PLPCTB110BL	341	PLPP006BK	285	PLPTD394	268	PLRT016	220
PLPCTB110CL	341	PLPP007BK	285	PLRC005	192	PLRT016BCK	220
PLPCTB110GR	341	PLPP008BK	285	PLRC005B	192	PLRT016CK	220
PLPCTB110RD	341	PLPP009BK	285	PLRCB001	250	PLRT1612	220
PLPCTB112BL	341	PLPP010BK	285	PLRCB002	250	PLRT1612BCK	220
PLPCTB112CL	341	PLPP011BK	285	PLRCF001H	227	PLRT1612CK	220
PLPCTB112GR	341	PLPP012BK	285	PLRCF001R	227	PLSB703	275
PLPCTB112RD	341	PLPR050C	218	PLRDH003	195	PLSC006CL	283
PLPCTB114BL	341	PLPR050M	218	PLRFC0001PC	239	PLSC012CL	283
PLPCTB114CL	341	PLPR063C	218	PLRFC0001PP	239	PLSC024CL	283
PLPCTB114GR	341	PLPR063M	218	PLRFC0001TL	239	PLSC064CL	283
PLPCTB114RD	341	PLPR075C	218	PLRFC0204PC	239	PLSD001	321
PLPCTB116BL	341	PLPR075M	218	PLRFC0204PP	239	PLSD002	321
PLPCTB116CL	341	PLPR088C	218	PLRFC0204TL	239	PLSD377	266
PLPCTB116GR	341	PLPR088M	218	PLRFC0608PC	239	PLSFT002PC	240
PLPCTB116RD	341	PLPR100C	218	PLRFC0608PP	239	PLSFT002PP	241
PLPCTB120BL	341	PLPR100M	218	PLRFC0608TL	239	PLSFT002TL	240
PLPCTB120CL	341	PLPR113C	218	PLRFC121822PC	239	PLSFT004PC	240
PLPCTB120GR	341	PLPR113M	218	PLRFC121822PP	239	PLSFT004PP	241
PLPCTB120RD	341	PLPR125C	218	PLRFC121822TL	239	PLSFT004TL	240
PLPCTB124BL	341	PLPR125M	218	PLRFT301PC	238	PLSFT006PC	240
PLPCTB124CL	341	PLPR150C	218	PLRFT301PP	239	PLSFT006PP	241
PLPCTB124GR	341	PLPR150M	218	PLRFT301TL	238	PLSFT006TL	240
PLPCTB124RD	341	PLPR200C	218	PLRFT302PC	238	PLSFT008PC	240
PLPCTB308BL	340	PLPR200M	218	PLRFT302PP	239	PLSFT008PP	241
PLPCTB308CL	340	PLPR501S	217	PLRFT302TL	238	PLSFT008TL	240
PLPCTB308GR	340	PLPR502S	217	PLRFT304PC	238	PLSFT012PC	240
PLPCTB308RD	340	PLPR503S	217	PLRFT304PP	239	PLSFT012PP	241
PLPCTB310BL	340	PLPR504S	217	PLRFT304TL	238	PLSFT012TL	240
PLPCTB310CL	340	PLPR505S	217	PLRFT306PC	238	PLSFT018PC	240
PLPCTB310GR	340	PLPR506S	217	PLRFT306PP	239	PLSFT018PP	241
PLPCTB310RD	340	PLPR507S	217	PLRFT306TL	238	PLSFT018TL	240
PLPCTB312BL	340	PLPR600AM	219	PLRFT308PC	238	PLSFT0204C	241
PLPCTB312CL	340	PLPR600CL	219	PLRFT308PP	239	PLSFT022PC	240
PLPCTB312GR	340	PLPR600RD	219	PLRFT308TL	238	PLSFT022PP	241
PLPCTB312RD	340	PLPR600SM	219	PLRFT312PC	238	PLSFT022TL	240
PLPCTB314BL	340	PLPR700BK	219	PLRFT312PP	239	PLSFT0608C	241
PLPCTB314CL	340	PLPR700CL	219	PLRFT312TL	238	PLSFT121822C	241
PLPCTB314GR	340	PLPR700RD	219	PLRFT318PC	238	PLSGTG006BG	291
PLPCTB314RD	340	PLPR800BK	219	PLRFT318PP	239	PLSGTG006BK	291
PLPCTB316BL	340	PLPR800CL	219	PLRFT318TL	238	PLSGTG006CL	291
PLPCTB316CL	340	PLPR800RD	219	PLRFT322PC	238	PLSGTG006GR	291
PLPCTB316GR	340	PLPR900BK	219	PLRFT322PP	239	PLSGTG006RD	291
PLPCTB316RD	340	PLPR900BL	219	PLRFT322TL	238	PLSGTG006WH	291
PLPCTB320BL	340	PLPR900CL	219	PLRM005W	327	PLSGTG009BG	291
PLPCTB320CL	340	PLPR900GR	219	PLRPD392	267	PLSGTG009BK	291
PLPCTB320GR	340	PLPR900RD	219	PLRPD396	267	PLSGTG009CL	291

# INDEX BY ITEM NUMBER

Item #	Page #	Item #	Page #	Item #	Page #	Item #	Page #
PLSGTG009GR	291	PLSS113WH	290	PLTHCG008C	206	PLHTTB008B	342
PLSGTG009RD	291	PLSS211BG	289	PLTHCP007C	207	PLHTTB008C	342
PLSGTG009WH	291	PLSS211BK	289	PLTHEP016C	204	PLHTTB008R	342
PLSGTG012BG	291	PLSS211CL	289	PLTHEP020C	204	PLHTTB010A	342
PLSGTG012BK	291	PLSS211GR	289	PLTHFT005C	206	PLHTTB010B	342
PLSGTG012CL	291	PLSS211RD	289	PLTHGL020C	207	PLHTTB010C	342
PLSGTG012GR	291	PLSS211WH	289	PLTHHC016C	207	PLHTTB010R	342
PLSGTG012RD	291	PLSS213BG	289	PLTHHC024C	207	PLHTTB012A	342
PLSGTG012WH	291	PLSS213BK	289	PLTHMG016C	204	PLHTTB012B	342
PLSL003BK	364	PLSS213CL	289	PLTHMG020C	204	PLHTTB012C	342
PLSL006BK	364	PLSS213GR	289	PLTHMR009C	206	PLHTTB012R	342
PLSL113BK	364	PLSS213RD	289	PLTHMR011C	206	PLHTTB016A	342
PLSL116BK	364	PLSS213WH	289	PLTHMT008C	206	PLHTTB016B	342
PLSNP01B	216	PLSSGR001	212	PLTHPS013C	203	PLHTTB016C	342
PLSNP01G	216	PLST1100BL	220	PLTHPS023C	203	PLHTTB016R	342
PLSNP01O	216	PLST1100BR	220	PLTHRG008C	205	PLHTTB020A	342
PLSNP01R	216	PLST1400BL	220	PLTHRG010C	205	PLHTTB020B	342
PLSNP01W	216	PLST1400BR	220	PLTHRG012C	205	PLHTTB020C	342
PLSNP01Y	216	PLST1418BL	220	PLTHRG208C	203	PLHTTB020R	342
PLSNP02B	216	PLST1418BR	220	PLTHRG210C	203	PLHTTB024A	342
PLSNP02G	216	PLST1600BL	220	PLTHRG212C	203	PLHTTB024B	342
PLSNP02O	216	PLST1600BR	220	PLTHSB008C	334	PLHTTB024C	342
PLSNP02R	216	PLST2700BL	220	PLTHSB008R	334	PLHTTB024R	342
PLSNP02W	216	PLST2700BR	220	PLTHSB008Y	334	PLHTTB032A	342
PLSNP02Y	216	PLSTD393	268	PLTHSB012C	334	PLHTTB032B	342
PLSP001	269	PLSVM1218BL	214	PLTHSB012R	334	PLHTTB032C	342
PLSP002D	327	PLSVM1218R	214	PLTHSB012Y	334	PLHTTB032R	342
PLSP010	298	PLTC010W	271	PLTHSB016CW	334	PLHTTB032TA	342
PLSP010HR	298	PLTC010WL	271	PLTHSB016RW	334	PLHTTB032TB	342
PLSP010SHR	298	PLTC020G	271	PLTHSB016YW	334	PLHTTB032TC	342
PLSP014	298	PLTC020GL	271	PLTHSB024C	334	PLHTTB032TR	342
PLSP014HR	298	PLTC020W	271	PLTHSB024CW	334	PLTHWD009C	208
PLSP014SHR	298	PLTC020WL	271	PLTHSB024R	334	PLTHWG011RC	207
PLSP016	298	PLTC023B	271	PLTHSB024RW	334	PLTHWG014RC	207
PLSP016HR	298	PLTC023BL	271	PLTHSB024Y	334	PLTHWG023RC	207
PLSP016SHR	298	PLTC023G	271	PLTHSB024YW	334	PLTHWG025RC	207
PLSP032BK	323	PLTC023GL	271	PLTHSB032CW	334	PLTHWP015C	204
PLSP032CH	323	PLTC023K	271	PLTHSB032RW	334	PLTHWP020C	204
PLSP032CL	323	PLTC023KL	271	PLTHSB032YW	334	PLTN4025	322
PLSP032WT	323	PLTC023R	271	PLTHSG001CC	205	PLTN4050	322
PLSP1013C	191	PLTC023RC	271	PLTHSG002AC	205	PLTN4100	322
PLSP1813C	191	PLTC023RL	271	PLTHSG002CC	205	PLTP050A	212
PLSP1826C	191	PLTC023RP	271	PLTHSG015CC	205	PLTP050S	212
PLSPT0802	181	PLTC032G	271	PLTHSG125SC	205	PLTSCD3812	268
PLSPT0902	181	PLTC032GH	271	PLTHSG130SC	205	PLTW085BK	337
PLSPT1102	181	PLTC032GL	271	PLTHSL001W		PLTW085BR	337
PLSS111BG	289	PLTC044G	271	PLTHSN024C	208	PLTWCS006	320
PLSS111BK	289	PLTC044GH	271	PLTHSS016C	208	PLTWRH078C	318
PLSS111CL	289	PLTC044GL	271	PLTHST012C	205	PLTWRH112C	318
PLSS111GR	289	PLTCD005	271	PLTHST014C	205	PLTWRH114C	318
PLSS111RD	289	PLTCD023		PLTHST212C	203	PLVS001	234
PLSS111WH	289	PLTD003	321	PLTHST214C	203	PLVS002	234
PLSS113BG	290	PLTHBK040C	206	PLHTB005A	342	PLVS003	234
PLSS113BK	290	PLTHBK140C	206	PLHTB005B	342	PLWB001	301
PLSS113CL	290	PLTHCF050CC	208	PLHTB005C	342	PLWB002	301
PLSS113GR	290	PLTHCF075NC	208	PLHTB005R	342	PLWB003	301
PLSS113RD	290	PLTHCF100CC	208	PLHTB008A	342	PLWB004	301

# INDEX BY ITEM NUMBER

P  
to  
S

Item #	Page #	Item #	Page #	Item #	Page #	Item #	Page #
PLWB005	301	PS3211W	90	RF2030BW	77	SD5609H	67
PLWB361	270	PS3214RD	87	RF2030G	80	SD5609J	72
PLWB361B	270	PS3214V	84	RF2030W	75	SD5612H	67
PLWB361W	270	PS3214W	90	RF2224BW	77	SD5612J	72
PLWC001	186	PS5004RD	88	RF2920G	80	SD5613H	67
PLWFC024	270	PS5004V	85	RF5065BW	77	SD5613J	72
PLWFC027	270	PS5004W	91	RF5112BW	77	SD5614H	67
PLWP032CL	204	PS5005RD	88	RF6016BW	76	SD5614J	72
PLWP064CL	204	PS5005V	85	RF7010B	77	SD6015H	67
PLWS020BK	333	PS5005W	91	RF7010W	77	SD6015J	72
PLWS020BKL	333	PS5006RD	88	RF9475BW	77	SD6018H	67
PLWS020WT	333	PS5006V	85	RYTP351A	270	SD6018J	72
PLWS020WTL	333	PS5006W	91	SB514N	82	SEJ001	264
PLWS042BK	333	PS5008RD	88	SB514S	82	SEJ002	264
PLWS042BKL	333	PS5008V	85	SB514W	82	SEJ003	264
PLWS042WT	333	PS5008W	91	SB520N	82	SEJ004	264
PLWS042WTL	333	PS5010RD	88	SB520S	82	SEJ004A	264
PLWS064BK	333	PS5010V	85	SB520W	82	SEJ008	264
PLWS064BKL	333	PS5010W	91	SB608N	82	SEJ009	264
PLWS064WT	333	PS5103RD	87	SB608S	82	SEJ010	264
PLWS064WTL	333	PS5103V	84	SB608W	82	SEJ011	264
PS1515RD	87	PS5103W	90	SB612N	82	SEJ012	264
PS1515V	84	PS5104RD	87	SB612S	82	SEJ013	264
PS1515W	90	PS5104V	84	SB612W	82	SEJ014	264
PS3008RD	87	PS5104W	90	SCSL001	256	SEJ18000	264
PS3008V	84	PS6013RD	88	SCSL002	256	SEJ20000	264
PS3008W	90	PS6013V	85	SCSL003	256	SEJ21000	264
PS3010RD	87	PS6013W	91	SCSL004	256	SEJ22000	264
PS3010V	84	PS9475RD	88	SCSL005	256	SEJ3201	263
PS3010W	90	PS9475V	85	SCSL006	256	SEJ35000C	260
PS3014RD	87	PS9475W	91	SCSL007	256	SEJ38000C	260
PS3014V	84	RER55ASL	262	SCSL008	256	SEJ45000C	262
PS3014W	90	RER55ASN	262	SCSL103	256	SEJ50000	263
PS3103RD	88	RF1006BW	76	SCSL104	256	SEJ50000T	263
PS3103V	85	RF1006G	79	SD2118H	67	SEJ60000	263
PS3103W	91	RF1010BW	76	SD2118J	72	SEJ6012	263
PS3105RD	88	RF1010G	79	SD2121H	67	SEJ64020	263
PS3105V	85	RF1016B	75	SD2121J	72	SEJ71000	179
PS3105W	91	RF1016BW	76	SD3206H	68	SEJ72000	179
PS3106RD	88	RF1016G	79	SD3206J	73	SEJ73000	179
PS3106V	85	RF1016W	75	SD3208H	68	SEJ74000	179
PS3106W	91	RF1018B	75	SD3208J	73	SEJ81000C	261
PS3110RD	88	RF1018BW	76	SD3210H	68	SEJ92000	265
PS3110V	85	RF1018G	79	SD3210J	73	SEJ92001C	265
PS3110W	91	RF1018W	75	SD3212H	68	SEJ92001R	265
PS3111RD	88	RF1020B	75	SD3212J	73	SEJB001	263
PS3111V	85	RF1020BW	76	SD3214H	68	SEJB001T	263
PS3111W	91	RF1020G	80	SD3214J	73	SEJB002	263
PS3204RD	88	RF1020W	75	SD3216H	68	SLADD05	201
PS3204V	85	RF1065BW	76	SD3216J	73	SLADD06	201
PS3204W	90	RF1112B	76	SD3314H	68	SLAL005	184
PS3208RD	87	RF2024B	75	SD3314J	73	SLAL01A	184
PS3208V	84	RF2024BW	77	SD3318H	68	SLAL01B	184
PS3208W	90	RF2024G	80	SD3318J	73	SLAL02A	184
PS3211RD	87	RF2024W	75	SD3324H	68	SLAL02B	184
PS3211V	84	RF2030B	75	SD3324J	73	SLAL03A	184



## INDEX BY ITEM NUMBER

Item #	Page #
SLAL03B	184
SLAL04A	184
SLAL04B	184
SLAM102	353
SLAM103	353
SLAM104	353
SLAM105	353
SLAM106	353
SLAM107	353
SLAM109	353
SLAT201	346
SLAT202	346
SLAT203	346
SLAT204	346
SLAT205	346
SLAT206	346
SLAT207	346
SLAT209	346
SLAT210	346
SLAT211	346
SLAT212	346
SLAT215	346
SLAT216	346
SLAT218	346
SLAT219	346
SLBELL001	326
SLBF001	229
SLBF002	229
SLBF003	229
SLBF004	229
SLBF005	229
SLBF006	229
SLBF007	229
SLBF008	229
SLBF009	229
SLBF010	229
SLBF011	229
SLBF012	229
SLBF013	229
SLBF014	229
SLBF015	229
SLBF101	228
SLBF102	228
SLBF103	228
SLBF105	228
SLBF106	228
SLBF109	228
SLBK013	343
SLBM001	237
SLBM002	237
SLBM003	237
SLBM004	237
SLBM005	237
SLBM006	237
SLBM007	237
SLBM008	237

Item #	Page #
SLBM009	237
SLBM010	237
SLBM011	237
SLBM012	237
SLBO002	209
SLBO003	209
SLBO004	209
SLBO005	209
SLBO106	209
SLBP0804W	295
SLBS022	211
SLBT075	293
SLBT095	293
SLBT115	293
SLBW004	328
SLCB008C	305
SLCB008F	305
SLCB010C	305
SLCB010F	305
SLCB012C	305
SLCB012F	305
SLCCA13	209
SLCF001	330
SLCF002	330
SLCF003	330
SLCH007	187
SLCIL11L	300
SLCIL11S	300
SLCIL13L	300
SLCIL13S	300
SLCIL15L	300
SLCIL15S	300
SLCJ007C	322
SLCJH002	322
SLCJH003	322
SLCJH004	322
SLCK007	311
SLCN001	171
SLCN004	210
SLCN005	210
SLCN006	210
SLCRT004	336
SLCS001	230
SLCS3172	331
SLCS3173	331
SLCS3174	331
SLCS3175	331
SLCS3176	331
SLCST006	336
SLCT310	230
SLCT312	230
SLCT314	230
SLCT316	230
SLCT318	230
SLDA008	279
SLDA010	279

Item #	Page #
SLDA012	279
SLDA016	279
SLDA020	279
SLDA024	279
SLDA030	279
SLDA040	279
SLDA050	279
SLDA060	279
SLDA070	279
SLDA100	279
SLDAOVAL	279
SLDB4008	309
SLDB4008C	309
SLDB4012	309
SLDB4012C	309
SLDB4016	309
SLDB4016C	309
SLDB4020	309
SLDB4020C	309
SLDK102	352
SLDK103	352
SLDK104	352
SLDK105	352
SLDK106	352
SLDK106F	352
SLDK107	352
SLDK108	352
SLDK109	352
SLDM201	347
SLDM202	347
SLDM203	347
SLDM204	347
SLDM205	347
SLDM206	347
SLDM207	347
SLDM208	347
SLDM209	347
SLDM210	347
SLDM211	347
SLDM212	347
SLDM215	347
SLDM218	347
SLDO001	356
SLDO002	356
SLDO003	356
SLDO004	356
SLDO005	356
SLDO006	356
SLDO007	356
SLDO008	356
SLDO009	356
SLDO011	356
SLDO102	356
SLDO103	356
SLDO104	356
SLDO105	356

Item #	Page #
SLDO106	356
SLDO107	356
SLDO109	356
SLDS006	277
SLDS006L	277
SLDS008	277
SLDS008L	277
SLDS010	277
SLDS010L	277
SLDS012	277
SLDS012L	277
SLDS016	277
SLDS016L	277
SLDS020	277
SLDS020L	277
SLDS024	277
SLDS024L	277
SLDS030	277
SLDS030L	277
SLDS040	277
SLDS040L	277
SLDS060P	298
SLDS206G	276
SLDS206P	276
SLDS208G	276
SLDS208P	276
SLDS210G	276
SLDS210P	276
SLDS212G	276
SLDS212P	276
SLDS216G	276
SLDS216P	276
SLDS220G	276
SLDS220P	276
SLDS224G	276
SLDS224P	276
SLDS230G	276
SLDS230P	276
SLDS240G	276
SLDS240P	276
SLDWO001	209
SLEC001	327
SLEC002	327
SLEL201	348
SLEL202	348
SLEL203	348
SLEL204	348
SLEL205	348
SLEL206	348
SLEL207	348
SLEL208	348
SLEL209	348
SLEL210	348
SLEL211	348
SLEL212	348
SLEL218	348

# INDEX BY ITEM NUMBER

S

Item #	Page #
SLER0301R	292
SLER0401R	292
SLER0401S	292
SLER0501R	292
SLER0601R	292
SLES102	353
SLES103	353
SLES104	353
SLES105	353
SLES106	353
SLES107	353
SLES109	353
SLFB001	319
SLFB002	319
SLFB003	319
SLFB004	319
SLFB005	319
SLFB006	319
SLFB007	319
SLFB008	319
SLFB009	319
SLFBP010	319
SLFBP014	319
SLFC001	231
SLFC002	231
SLFC004	231
SLFC006	231
SLFC007	231
SLFC008	231
SLFCR005	329
SLFD001	184
SLFD002	184
SLFDS310	273
SLFDS385	273
SLFDS510	273
SLFFB001	281
SLFFB001L	281
SLFFB001R	281
SLFFC001	327
SLFFC003	327
SLFFC005	327
SLFM001	184
SLFN005	235
SLFN006	235
SLFS008	201
SLFT065P	296
SLFT065S	296
SLGB003	326
SLGB005	326
SLGB008	326
SLGB013	258
SLGB018	258
SLGB024	258
SLGB026	211
SLGD001	354
SLGD002	354

Item #	Page #
SLGD003	354
SLGD004	354
SLGD005	354
SLGD006	354
SLGD007	354
SLGD008	354
SLGD009	354
SLGD010	354
SLGD011	354
SLGF004	345
SLGL001	284
SLGR004	282
SLGR025	282
SLGT008	328
SLGT012	328
SLGT020	328
SLGT108	328
SLGT112	328
SLGT120	328
SLHF1620	269
SLHF1625	269
SLHF2016	269
SLHF2020	269
SLHF2025	269
SLHO030	212
SLHT064P	296
SLIC001	236
SLIC002	236
SLIG001	213
SLIG002	213
SLIG003	213
SLIG004	213
SLIG008	213
SLIL001	300
SLIL002	300
SLIL003	300
SLIL004	300
SLINS001	210
SLINS002	210
SLIP001	237
SLIP002	237
SLIP003	237
SLIP004	237
SLIP005	237
SLIP006	237
SLIP007	237
SLIP008	237
SLIT007	293
SLJG001	213
SLJG002	213
SLJG003	213
SLJS031	211
SLKB164	331
SLKB166	331
SLKBS011	211
SLKCC005	253

Item #	Page #
SLKCP008	302
SLKCP010	302
SLKCP012	302
SLKCP108	302
SLKCP110	302
SLKCP112	302
SLKCP208	302
SLKCP208R	302
SLKCP210	302
SLKCP210R	302
SLKF002	172
SLKF003HK	172
SLKF004HK	172
SLKF005HK	172
SLKF012	173
SLKF016	173
SLKF017	173
SLKF018	173
SLKF019	173
SLKF020	173
SLKF021	172
SLKF025	173
SLKGH010	215
SLKGH010C	215
SLKGH016	215
SLKGH016C	215
SLKGH024	215
SLKGH024C	215
SLKMP012	189
SLKMP024	189
SLKMP124	189
SLKR012	258
SLKSW008	295
SLKSW095	295
SLKSW108	295
SLKVP006	282
SLKVP006RD	282
SLKW048	302
SLLA001	285
SLLA002	285
SLLC006A	345
SLLC006B	345
SLLC116W	345
SLLD002	278
SLLD002A	278
SLLD003	278
SLLD003A	278
SLLD004	278
SLLD004A	278
SLLD006	278
SLLD006A	278
SLLD008	278
SLLD008A	278
SLLD102P	278
SLLD102PA	278
SLLD103P	278

Item #	Page #
SLLD103PA	278
SLLD104P	278
SLLD104PA	278
SLLD106P	278
SLLD106PA	278
SLLD108P	278
SLLD108PA	278
SLLD309	168
SLLD310	168
SLLD311	168
SLMB001	299
SLMB002	299
SLMB003	299
SLMB004	299
SLMB005	299
SLMB006	299
SLMB007	299
SLMB008	299
SLMB009	299
SLMB030	299
SLMB201	299
SLMB202	299
SLMB203	299
SLMB204	299
SLMB205	299
SLMB206	299
SLMB207	299
SLMB208	299
SLMB209	299
SLMBH003	266
SLMBH024	266
SLMBP075	300
SLMBP150	300
SLMBP200	300
SLMC001	213
SLMC2414	196
SLMC2415	196
SLMC2416	196
SLME012	329
SLME020	329
SLME033	329
SLME050	329
SLME066	329
SLME266	329
SLMH001	323
SLMH002	323
SLMH008	322
SLMH012	322
SLMH018	322
SLMLB002	234
SLMP0018	329
SLMP0024	329
SLMP0040	329
SLMP024	253
SLMP030	253
SLMP036	253

# INDEX BY ITEM NUMBER

S

Item #	Page #
SLMP042	253
SLMP048	253
SLMP054	253
SLMP060	253
SLMS013V	196
SLMS025L	196
SLMS025V	196
SLMS033V	196
SLMS050L	196
SLMS050V	196
SLMS100L	196
SLMS100V	196
SLMS150L	196
SLMW040	302
SLNH001	321
SLNH002	321
SLNP001	354
SLNP002	354
SLNP003	354
SLNP004	354
SLNP005	354
SLNP006	354
SLNP007	354
SLNP008	354
SLNP009	354
SLNP010	354
SLNP011	354
SLNS001	170
SLNS002	170
SLNS005	170
SLNS536	170
SLNS553	170
SLOK008	297
SLOK010	297
SLOK012	297
SLOL001	284
SLOL002	284
SLOL003	284
SLOL004	284
SLOL005	284
SLOL006	284
SLOL007	284
SLOL007H	284
SLOL008	284
SLOL201	288
SLOL202	288
SLOL203	288
SLOL204	288
SLOL205	288
SLOL206	288
SLOL207	288
SLOL208	288
SLOP010	230
SLOP012	230
SLOP014	230
SLOP016	230
SLOP018	230

Item #	Page #
SLOP020	230
SLOP022	230
SLOP024	230
SLOP026	230
SLOS001	304
SLOS002	304
SLPAL002	237
SLPAL006	237
SLPAL009	237
SLPAL013	237
SLPB030	211
SLPBA111	287
SLPBA112	287
SLPBA113	287
SLPBA211	287
SLPBA212	287
SLPBA213	287
SLPBA311	287
SLPBA312	287
SLPBA313	287
SLPC230	231
SLPC250	231
SLPG008D	200
SLPG008S	200
SLPH002	301
SLPH003	301
SLPH004	301
SLPH005	301
SLPH007	301
SLPHAP066	236
SLPHAP068	236
SLPHAP088	236
SLPMR018	282
SLPMR018C	282
SLPMR024	282
SLPMR024C	282
SLPR009	295
SLPR016	295
SLPS004P	298
SLPS027P	193
SLPSP008	297
SLPSP010	297
SLPSP010C	297
SLPSP012	297
SLPSP014	297
SLRACK0019	254
SLRACK0023	254
SLRACK1050	254
SLRACK1114	255
SLRACK1234	254
SLRACK1313	255
SLRACK1434	254
SLRACK1624	255
SLRACK1725	255
SLRACK1734	254
SLRBC001	329
SLRBC002	329

Item #	Page #
SLRBC003	329
SLRCD001	328
SLRCF001	226
SLRCF001F	226
SLRCF002	226
SLRCF0031GH	228
SLRCF005	226
SLRCF0171G	225
SLRCF0825	223
SLRCF0831GH	224
SLRCF0833BT	225
SLRCF0833GH	224
SLRCF0834GH	225
SLRCF0836GH	224
SLRCF0840	223
SLRCF0860	222
SLRCF100	227
SLRCF111	227
SLRCF112	227
SLRCF113	227
SLRCF114	227
SLRCF115	227
SLRCF511	223
SLRCF7100	227
SLRCF8307	222
SLRCF8311	222
SLRCF8532	223
SLRCF8533	223
SLRCF8632	222
SLRCF8633	222
SLRD008	201
SLRD020	201
SLRD038	201
SLRDH001	195
SLRDH002	195
SLRK008	297
SLRK010	297
SLRK012	297
SLRMH003	323
SLSA001	327
SLSA002	327
SLSA003	327
SLSA004	327
SLSAP4030	310
SLSAP4050	310
SLSAP4070	310
SLSBA018	287
SLSBA021	287
SLSBA111	287
SLSBA112	287
SLSBA113	287
SLSBA211	287
SLSBA212	287
SLSBA213	287
SLSBA311	287
SLSBA312	287
SLSBA313	287

Item #	Page #
SLSBA411	286
SLSBA412	286
SLSBA413	286
SLSBA511	286
SLSBA512	286
SLSBA513	286
SLSBA611	286
SLSBA612	286
SLSBA613	286
SLSBP4015	310
SLSBP4020	310
SLSBP4025	310
SLSBP4030	310
SLSC001	275
SLSC002	275
SLSC003	275
SLSCB04	274
SLSD040H	266
SLSD040V	266
SLSF111	355
SLSF112	355
SLSF113	355
SLSF114	355
SLSF115	355
SLSF116	355
SLSF117	355
SLSF118	355
SLSF119	355
SLSF120	355
SLSFP4008	309
SLSFP4009	309
SLSFP4011	309
SLSFP4012	309
SLSFP4014	309
SLSFP4108	309
SLSFP4109	309
SLSFP4111	309
SLSFP4112	309
SLSFP4114	309
SLSK001	304
SLSK002	304
SLSK003	304
SLSK008	343
SLSK016	343
SLSK017	343
SLSK108	343
SLSK116	343
SLSK117	343
SLSKGK001	343
SLSKGK002	343
SLSKR004	169
SLSKR004GV	170
SLSKR006	169
SLSKR006GV	170
SLSKR008	169
SLSKR008GV	170
SLSKR010	169

# INDEX BY ITEM NUMBER

S

Item #	Page #
SLSKR010GV	170
SLSKR012	169
SLSKR012GV	170
SLSKR014	169
SLSKR014GV	170
SLSKR104GV	170
SLSKR106GV	170
SLSKR108GV	170
SLSKR110GV	170
SLSKR112GV	170
SLSKR114GV	170
SLSKR1213	304
SLSKR512GV	170
SLSKR513	304
SLSKR55	304
SLSKR60RL	304
SLSKR612GV	170
SLSKR613	304
SLSKR65	304
SLSKR65M	304
SLSKR70	304
SLSKR70M	304
SLSKR713	304
SLSKR80RL	304
SLSKR813	304
SLSKR875	304
SLSKR913	304
SLSKS007	304
SLSKS009	304
SLSKS514	304
SLSKS714	304
SLSL001	284
SLSL002	284
SLSL003	284
SLSM202	349
SLSM203	349
SLSM204	349
SLSM205	349
SLSM206	349
SLSM207	349
SLSM208	349
SLSM209	349
SLSM210	349
SLSM211	349
SLSM212	349
SLSN001	275
SLSN001W	275
SLSN002	275
SLSN002W	275
SLSN003	275
SLSN006D	345
SLSN006F	345
SLSN006T	345
SLSN335	275
SLSP1813	191
SLSP1826	191

Item #	Page #
SLSPA001	168
SLSPA002	168
SLSPC4012	311
SLSPC4012C	311
SLSPC4020	311
SLSPC4020C	311
SLSPG001	236
SLSPIN001	326
SLSPR022S	210
SLSPR032S	210
SLSPR042S	210
SLSPS4008	310
SLSPS4008C	310
SLSPS4012	310
SLSPS4012C	310
SLSPS4016	310
SLSPS4016C	310
SLSPS4020	310
SLSPS4020C	310
SLSPS4024	310
SLSPS4024C	310
SLSPS4032	310
SLSPS4032C	310
SLSPS4040	310
SLSPS4040C	310
SLSPS4060	310
SLSPS4060C	310
SLSPS4080	310
SLSPS4080C	310
SLSPS4100	310
SLSPS4100C	310
SLSR010	293
SLSR010TP	330
SLSR015	293
SLSR210	330
SLSS001	355
SLSS002	355
SLSS003	355
SLSS004	355
SLSS005	355
SLSS006	355
SLSS007	355
SLSS008	355
SLSS009	355
SLSS010	355
SLSS011	355
SLSSD003	328
SLSSD005	328
SLSSP4020	309
SLSSP4035	309
SLSSP4045	309
SLSSP4060	309
SLSSP4076	309
SLSSP4100	309
SLST001	265
SLST002	265

Item #	Page #
SLSTN006	305
SLSTN008	305
SLSTN009	305
SLSTN010	305
SLSTN3106	303
SLSTN3108	303
SLSTN3110	303
SLSTN3206	303
SLSTN3208	303
SLSTN3210	303
SLSTN3306	303
SLSTN3308	303
SLSTN3308R	303
SLSTN3310	303
SLSTN3310R	303
SLSTN3312R	303
SLSTN3314R	303
SLSTN3406	303
SLSTN3408	303
SLSTN3410	303
SLSTN5106	303
SLSTN5106PB	305
SLSTN5108	303
SLSTN5108PB	305
SLSTN5110	303
SLSTN5110PB	305
SLSTN5206	303
SLSTN5206PB	305
SLSTN5208	303
SLSTN5208PB	305
SLSTN5210	303
SLSTN5210PB	305
SLSTN5306	303
SLSTN5306PB	305
SLSTN5308	303
SLSTN5308PB	305
SLSTN5310	303
SLSTN5310PB	305
SLSTN5406	303
SLSTN5406PB	305
SLSTN5408	303
SLSTN5408PB	305
SLSTN5410	303
SLSTN5410PB	305
SLSTP714	176
SLSTR30	275
SLTA08	281
SLTB001	330
SLTB002	330
SLTB003	330
SLTB004	330
SLTB005	330
SLTB006	330
SLTB018R	281
SLTB018T	281
SLTCD012	328

Item #	Page #
SLTCD024	328
SLTD101	266
SLTD102	266
SLTD301	267
SLTD302	267
SLTE102	352
SLTE103	352
SLTE104	352
SLTE106	352
SLTE107	352
SLTE109	352
SLTG1600B	294
SLTG1600Y	294
SLTG208	293
SLTG309	293
SLTG310	293
SLTG407	293
SLTG408	293
SLTG607	293
SLTG608	293
SLTG706	293
SLTG709	293
SLTG712	293
SLTG810B	294
SLTG810G	294
SLTG810K	294
SLTG810R	294
SLTG810Y	294
SLTG812B	294
SLTG812G	294
SLTG812K	294
SLTG812R	294
SLTG812Y	294
SLTG816B	294
SLTG816G	294
SLTG816K	294
SLTG816R	294
SLTG816Y	294
SLTH160	257
SLTH160C	257
SLTH200	257
SLTH220C	257
SLTH550	257
SLTH550C	257
SLTH600	258
SLTHAB012	235
SLTHAB012D	235
SLTHAB020	235
SLTHAB020D	235
SLTHCS001	279
SLTHCS001B	279
SLTHD080	257
SLTHD400	257
SLTHD550	257
SLTHDP012	279
SLTHDP016	279

# INDEX BY ITEM NUMBER

Item #	Page #
SLTHDP020	279
SLTHDP024	279
SLTHDP112	279
SLTHDP116	279
SLTHDP120	279
SLTHDP124	279
SLTHDS005	298
SLTHFB010	236
SLTHFB017	236
SLTHL080	258
SLTHL400	258
SLTHUH001	286
SLTHUT010	292
SLTHUT012	292
SLTHUT016	292
SLTHUT107	292
SLTHUT110	292
SLTHUT112	292
SLTHUT116	292
SLTHUT210	292
SLTHUT212	292
SLTHUT216	292
SLTHUT507	294
SLTHUT610	293
SLTHUT612	293
SLTL001	284
SLTL002	284
SLTL003	284
SLTL004	284
SLTL005	284
SLTL006	284
SLTL007	284
SLTL008	284
SLTL009	284
SLTL010	284
SLTL011	284
SLTL012	284
SLTMA012	282
SLTMA018	282
SLTMA018C	282
SLTMA024	282
SLTMA024C	282
SLTO18	281
SLTR012F	337
SLTR012W	337
SLTR023F	337
SLTR023W	337
SLTR034F	337
SLTR034W	337
SLTR045F	337
SLTS001	357
SLTS002	357
SLTS3151	330
SLTS3152	330
SLTS3153	330
SLTS3154	330

Item #	Page #
SLTS3155	330
SLTS3156	330
SLTSCD500	267
SLTTBN024	293
SLTTMN008	293
SLTTS001	285
SLTTSP001	285
SLTWBS003	298
SLTWBS004	298
SLTWBS007	297
SLTWBT006	296
SLTWBT010	296
SLTWBT075	296
SLTWBT110	296
SLTWBT210	296
SLTWCH018	326
SLTWCH024	326
SLTWCH030	326
SLTWCH036	326
SLTWCH044	326
SLTWCK007	345
SLTWDS006	298
SLTWHT003	296
SLTWHT004	296
SLTWHT005	296
SLTWHT008	296
SLTWMH004	323
SLTWMH006	323
SLTWPC002	200
SLTWPC004	200
SLTWPF013	297
SLTWPF021	297
SLTWPS002	193
SLTWPS003	296
SLTWPS005	200
SLTWPS006	200
SLTWPT003	296
SLTWPT003S	296
SLTWST010	296
SLWB001	221
SLWB003	221
SLWD001	356
SLWD002	356
SLWD003	356
SLWD004	356
SLWD005	356
SLWD006	356
SLWD007	356
SLWD008	356
SLWD009	356
SLWD011	356
SLWD102	356
SLWD103	356
SLWD104	356
SLWD105	356
SLWD106	356

Item #	Page #
SLWD107	356
SLWD109	356
SLWG001	255
SLWG002	255
SLWG003	255
SLWG1216	255
SLWG1622	255
SLWG1624	255
SLWH201	350
SLWH202	350
SLWH203	350
SLWH204	350
SLWH205	350
SLWH206	350
SLWH207	350
SLWH208	350
SLWH209	350
SLWH210	350
SLWH211	350
SLWH212	350
SLWH216	350
SLWK008	174
SLWK008C	174
SLWL001	301
SLWP064	329
SLWPF010	302
SLWPF012	302
SLWPF014	302
SLWPF016	302
SLWPF018	302
SLWPF020	302
SLWPF022	302
SLWPP110	302
SLWPP112	302
SLWPP114	302
SLWPP116	302
SLWPP118	302
SLWS004P	297
SLWT42412F	366
SLWT42418F	366
SLWT42424F	366
SLWT42430F	366
SLWT42436F	366
SLWT42448F	366
SLWT42448F4	367
SLWT42460F	366
SLWT42460F4	367
SLWT42472F	366
SLWT42472F4	367
SLWT42484F	366
SLWT42484F4	367
SLWT42496F	366
SLWT42496F4	367
SLWT43012F	366
SLWT43018F	366
SLWT43024F	366

Item #	Page #
SLWT43030F	366
SLWT43036F	366
SLWT43048F	366
SLWT43048F4	367
SLWT43060F	366
SLWT43060F4	367
SLWT43072F	366
SLWT43072F4	367
SLWT43084F	366
SLWT43084F4	367
SLWT43096F	366
SLWT43096F4	367
SLWTC005	367
SLWTC005B	367
SLYK201	351
SLYK202	351
SLYK203	351
SLYK204	351
SLYK205	351
SLYK206	351
SLYK207	351
SLYK208	351
SLYK209	351
SLYK210	351
SLYK211	351
SLYK212	351
SSCD003	210
SSCD004	210
SSCD005	210
SSCD006	210
STPA2001	232
STPA2002	232
STPA2004	232
STPA2006	232
STPA2121	232
STPA2122	232
STPA2122L	232
STPA2124	232
STPA2124L	232
STPA2126	232
STPA2126L	232
STPA2132	232
STPA2134	232
STPA2136	232
STPA2142	232
STPA2144	232
STPA2146	232
STPA2162	232
STPA2164	232
STPA2166	232
STPA2192	232
STPA2194	232
STPA2232	232
STPA2234	232
STPA2236	232
STPA3001	232



# INDEX BY ITEM NUMBER

S  
to  
Y

Item #	Page #
STPA3001PF	233
STPA3002	232
STPA3002PF	233
STPA3004	232
STPA3004PF	233
STPA3006	232
STPA3006PF	233
STPA3022	
STPA3121	232
STPA3121PF	233
STPA3122	232
STPA3122L	232
STPA3122PF	233
STPA3124	232
STPA3124L	232
STPA3124PF	233
STPA3126	232
STPA3126L	232
STPA3126PF	233
STPA3132	232
STPA3134	232
STPA3136	232
STPA3142	232
STPA3144	232
STPA3146	232
STPA3162	232
STPA3164	232
STPA3166	232
STPA3192	232
STPA3194	232
STPA3232	232
STPA3234	232
STPA3236	232
STPA4002	233
STPA4004	233
STPA4006	233
STPA4122	233
STPA4124	233
STPA4126	233
STPA4132	233
STPA4134	233
STPA4136	233
STPA4142	233
STPA4144	233
STPA4146	233
STPA4162	233
STPA4164	233
STPA4166	233
STPA4192	233
STPA4194	233
STPA5000C	233
STPA5000CS	233
STPA5120C	233
STPA5120CL	233
STPA5120CS	233
STPA5120CSL	233
STPA5130C	233
STPA5130CS	233

Item #	Page #
STPA5140C	233
STPA5140CS	233
STPA5160C	233
STPA5160CS	233
STPA5190C	233
STPA5190CS	233
STPA5230C	233
STPA5230CS	233
T-111	185
T-111C	185
T-333	185
TF001	175
TF002	175
TIM-60	256
TJWB007	331
TJWB010	331
W7009	165
W7101	165
W7102	165
W7103	165
W7104	165
W7105	165
W7106	165
WBEP014	365
WBEP018	365
WBEP021	365
WBEP024	365
WBEP214	365
WBEP218	365
WBEP221	365
WBEP224	365
WBSV014	365
WBSV018	365
WBSV021	365
WBSV024	365
WBSV214	365
WBSV218	365
WBSV221	365
WBSV224	365
WDBS011H	307
WDBS014	307
WDBS020H	307
WDBS027H	307
WDFJ001	343
WDGB012	258
WDGB018	258
WDGB024	258
WDML008W	211
WDPB001	259
WDPB001N	259
WDPB002	259
WDPB002N	259
WDPB003	259
WDPB003N	259
WDPB004	259
WDPB004N	259
WDPB005	259
WDPB005N	259

Item #	Page #
WDPB006	259
WDPB006N	259
WDPB037	307
WDPP1222	200
WDPP1236	200
WDPP1242	200
WDPP1424	200
WDPP1436	200
WDPP1442	200
WDPP1642	200
WDPP1842	200
WDPP2042	200
WDRNP013	
WDRNP015	
WDRNP018	
WDSP012	168
WDSP014	168
WDSP016	168
WDSP018	168
WDSP1107	344
WDSP1108	344
WDTHBS018	357
WDTHBS019	357
WDTHBS020	357
WDTHHC018A	357
WDTHHC019A	357
WDTHHC020A	357
WDTHMP018	253
WDTHMP020	253
WDTHMP024	253
WDTHMP030	253
WDTHMP036	253
WDTHMP042	253
WDTHMP048	253
WDTHMP054	253
WDTHMP060	253
WDTHTS032	357
WDTSB006	337
WDTSB008	337
WDTSB010	337
WDTSB012	337
WDTSB014	337
WDTSB016	337
WDTSB018	337
WDTSB020	337
WDW06768	209
WDWB008	307
WDWB012	307
WDWB020	307
WOBOAT61	182
WOBOAT76	182
WOBOAT90	182
WOBR43	182
WOBR57	182
WSPB001	183
WSPB002	183
WSPB003	183
WSPW001	183

Item #	Page #
WSPW002	183
WSPW003	183
Y-15	183
Y-35	183
Y-55	183
Y-75	183
Y-95	183



## CREDIT POLICY

Standard terms are **Cash-In Advance** or **Net 30 Days** (with approval credit). All new accounts should supply three (3) trade references and bank's name and address. No order will be processed until a satisfactory credit check has been made or unless the order is accompanied by a CREDIT CARD payment. **No orders will be shipped C.O.D. without prior credit approval.** Credit limits will be established and communicated upon approval of credit. Increased credit limits can only be achieved by a history of prompt payments. Late payments will be charged interest at the rate of 1½% per month or the highest allowable by law on all invoices over 30 days.

## RETURN POLICY

To ensure proper credit, **all returned merchandise must have a Return Goods Authorization (RGA) Number.** All goods returned for credit will only be accepted within sixty (60) days of original invoice date. All changes to orders or cancellations will be at the discretion of THUNDER GROUP. Charges for changes will be in accordance with any work already processed before change is requested. Returned goods must be in their original packaging & in restocking condition. Absolutely no returns after merchandise has been used. All authorized returns are subject to a 15% restocking charge and must be shipped back on a prepaid basis.

## DAMAGED MERCHANDISE

Inspect the shipment as soon as received thoroughly. All our shipments have been counted and accepted by carriers. If any concealed loss or damage is discovered, please contact the freight company at once and request an inspection. If the freight company does not make the inspection, file an affidavit specifying date of notification and freight company's failure to inspect. This will support your claim properly in the future. THUNDER GROUP is **NOT** responsible for any loss or damage once the delivery receipt is signed by the customer.

## SHIPPING POLICY

THUNDER GROUP will make every attempt to ship the best way in the absence of specific written shipping instructions. THUNDER GROUP reserves the right to delay or cancel all shipments if the account is delinquent or exceeds credit limit. THUNDER GROUP will endeavor to ship as quickly as possible (usually three to five days on standard items). If a specific ship date is required, please indicate that date along with the words "MUST SHIP". If THUNDER GROUP is unable to meet your requested ship date, we will make every effort to notify you as quickly as possible. **THUNDER GROUP is not responsible for any delays in shipment for causes beyond its control.**

## MINIMUM ORDER POLICY

All prices are quoted F.O.B. Los Angeles or Warehouses and are subject to change without notice. **Minimum initial order is \$250 net, Minimum re-order is \$150 net.** MERCHANDISE ONLY SOLD IN INNER CASE PACK. A minimum 10% upcharge will be assessed for any broken inner pack quantities on applicable products. "Sold by Master Pack Only" items are excluded from Inner Pack breaking. All Back Orders are automatically cancelled unless noted on original purchase orders.





# THUNDER GROUP®

780 South Nogales Street, City of Industry, CA 91748

**CITY OF INDUSTRY, CA**

Tel: 626.935.1605

Toll Free: 866.827.4664

Fax: 626.935.1609

Email: cservice@tarhong.com

Web: www.thundergroup.com

## NEW ACCOUNT APPLICATION

**For Dealer & Distributor only**

DATE: \_\_\_\_\_

RESALES NO.: \_\_\_\_\_

TH NO.: \_\_\_\_\_

D & B NO.: \_\_\_\_\_

### APPLICATION INFORMATION

COMPANY NAME \_\_\_\_\_

ADDRESS \_\_\_\_\_

CITY \_\_\_\_\_ STATE \_\_\_\_\_ ZIP \_\_\_\_\_

CONTACT PERSON \_\_\_\_\_

ACCOUNTS PAYABLE CONTACT \_\_\_\_\_ PHONE NUMBER \_\_\_\_\_

NUMBER OF EMPLOYEES HERE \_\_\_\_\_ NO. OF YEARS IN BUSINESS UNDER THIS NAME \_\_\_\_\_ SALES VOLUME \_\_\_\_\_ CREDIT LINE REQUESTED \_\_\_\_\_

#### TYPE OF BUSINESS

SOLE PROPRIETORSHIP

PARTNERSHIP

CORPORATION IN STATE OF \_\_\_\_\_

SUBSIDIARY

DIVISION

<b>OWNERSHIP</b>	NAME OF OWNER	PHONE NUMBER	FAX NUMBER
	HOME ADDRESS	CITY	STATE ZIP
	NAME OF OWNER	PHONE NUMBER	FAX NUMBER
	HOME ADDRESS	CITY	STATE ZIP

<b>TRADE REFERENCE</b>	NAME OF BUSINESS	PHONE NUMBER	FAX NUMBER	CONTACT PERSON
	ADDRESS	CITY	STATE	ZIP
	NAME OF BUSINESS	PHONE NUMBER	FAX NUMBER	CONTACT PERSON
	ADDRESS	CITY	STATE	ZIP
	NAME OF BUSINESS	PHONE NUMBER	FAX NUMBER	CONTACT PERSON
	ADDRESS	CITY	STATE	ZIP
	NAME OF BUSINESS	PHONE NUMBER	FAX NUMBER	CONTACT PERSON
	ADDRESS	CITY	STATE	ZIP

<b>BANK REFERENCE</b>	NAME OF BANK	PHONE NUMBER	FAX NUMBER
	ADDRESS	CITY	STATE ZIP

### PLEASE ATTACH A VALID COPY OF YOUR RESALE CERTIFICATE

APPROVED DISCOUNT: \_\_\_\_\_ APPROVED TERM: \_\_\_\_\_

CREDIT APPROVED \_\_\_\_\_  
 CREDIT DISAPPROVED \_\_\_\_\_

DATE \_\_\_\_ / \_\_\_\_ / \_\_\_\_

All statements made herein are true and accurate. We here by indemnify the above company and its agents, from and any liability resulting from the credit application.

AUTHORIZED SIGNATURE \_\_\_\_\_

TITLE \_\_\_\_\_ DATE \_\_\_\_ / \_\_\_\_ / \_\_\_\_



# Purchase Order Form

www.thundergroup.com

## FAX TO:

**City of Industry, CA**  
 Tel: 866.827.4664  
 Fax: 626.935.1609  
 Fax: 626.935.1615

**Houston, TX**  
 Tel: 866.690.0111  
 Fax: 713.690.0123  
 eFax: 626.465.4692

**Edison, NJ**  
 Tel: 732.777.1977  
 Fax: 732.777.0117  
 eFax: 626.551.0388

**Tinley Park, IL**  
 Tel: (855) 395-5560  
 Fax: (708) 429-7125

**Tamarac, FL**  
 Tel: 877-766-6525  
 Fax: 954-337-0222

COMPANY NAME \_\_\_\_\_

ORDER DATE \_\_\_\_\_

BILL TO ADDRESS \_\_\_\_\_

REQUIRED DATE \_\_\_\_\_

TELEPHONE \_\_\_\_\_ BUYER \_\_\_\_\_

PURCHASE ORDER # \_\_\_\_\_

FAX \_\_\_\_\_ SALES REP \_\_\_\_\_

C.I.A.  TERM

SHIP  WILL CALL

ITEM NO.	DESCRIPTION	QUANTITY	U/M	UNIT PRICE	TOTAL AMOUNT
				Subtotal	\$

Ship To Address (if different from above) \_\_\_\_\_

Third Party Billing Address \_\_\_\_\_

NOTATIONS:

\_\_\_\_\_

\_\_\_\_\_

## 5 MAJOR STEPS

1. Call the Service Center
2. Provide Proof of Purchase and Serial Number
3. Obtain a RGA number
4. Pack well and send back.
5. Repair and return back to the customer

Distributor should NEVER exchange the product to the Customer without first consult with Thunder Group's Customer Service Department. We will not honor any return or exchange without a RGA number.



# THUNDER GROUP<sup>®</sup>

[www.thundergroup.com](http://www.thundergroup.com)

### SUBJECT: RETURN AUTHORIZATION POLICY AND PROCEDURE

In the event that customers have a problem, either warranty or non-warranty related; customers should take the following steps to ensure the problem is handled professionally.

When a problem arises, customers have to call in the following Thunder Group Service Center:

- City of Industry, CA Tel: 866.TARHONG Fax: 626.935.1609

How to determine if the problem is a warranty-related problem:

- It has to be under the manufacturer original warranty.
  - a. 1 year from the date of original purchase by the end user for all **ELECTRIC** Rice Cooker/Warmer Products; or
  - b. 1 year from the date of original purchase by the end user for all **Rinnai GAS** Rice Cooker/Grill
  - c. 5 Year Limited warranty against manufacturer defect, i.e. rust on all chrome and epoxy plated shelving.
- Customers/End Users have to present proof of purchase from its supplier or vendor in order to valid the warranty period. Fax copy is acceptable.
- Customers/End users have to provide a valid serial number for the product.
- No sign of misuse or abuse of the products.

If the problem is determined to be a **warranty-related** problem:

- Return Authorization Specialist will issue a RGA number to the customer.
- Customers have 30 days to return the product(s), freight pre-paid, to our service center.
- On-site technician will determine the cause of the problem and perform any necessary repair (repair time is usually 7 days, however, Thunder Group reserves the right to extend the length of the repair if the problem needs more special attention).
- Thunder Group is responsible for all labor and parts.
- Products will be shipped back to the customer, freight pre-paid.
- Warranty for the repair work is 30 days or the remaining of the original warranty period; whichever is favorable to the customer.

If the problem is determined to be a **non-warranty-related** problem:

- Customers can request parts-sheet to be faxed to them and order parts in order to perform the repair themselves; or
- Customers can send back the product for a non-warranty repair with authorization to repair the unit.
- Repair fee is **USD 85.00** per hour plus the cost of parts.
- Product will be shipped back to the customer at freight collect.

**Thunder Group will not honor any payment deduction for warranty-related issue without authorization or damages caused by shipping.  
Credit Card Payment: Surcharge will be applied.**

#### RECOMMENDATION:

- Customer should keep the original Sales receipt and the Serial number during the warranty period.
- Customer should fill out and send back the warranty card that came with the product upon purchase.
- Customer should always maintain and clean the products from dusts and cooking residues.
- Customer should always unplug the unit when not using.
- Always read the user manual/warranty policy before operating the unit.

#### CALIFORNIA

780 South Nogales St.  
City of Industry, CA 91748  
Tel: 866-827-4664  
Fax: 626-935-1609

#### ILLINOIS

8402 #E West 183rd St.  
Tinley Park, IL 60487  
Tel: 855-395-5560  
Fax: 708-429-7125

#### FLORIDA

10599 NW 67th St.  
Tamarac, FL 33321  
Tel: 877-766-6525  
Fax: 954-337-0222

#### TEXAS

10702 Cash Rd.  
Stafford, TX 77477  
Tel: 713-690-0111  
Fax: 713-690-0123

#### NEW JERSEY

33 Truman Drive South  
Edison, NJ 08817  
Tel: 732-777-1977  
Fax: 732-777-0117

**CORPORATE - CALIFORNIA**

780 South Nogales Street  
City of Industry, CA 91748  
Tel: (626) 935-1605  
Fax: (626) 935-1609

**NEW YORK BRANCH**

33 Truman Drive South  
Edison, NJ 08817  
Tel: (732) 777-1977  
Fax: (732) 777-0117  
eFax: (626) 551-0388

**TEXAS BRANCH**

10702 Cash Road  
Stafford, TX 77477  
Tel: (713) 690-0111  
Fax: (713) 690-0123  
eFax: (626) 465-4692



**ILLINOIS BRANCH**

8402 #E West 183rd Street  
Tinley Park, IL 60487  
Tel: (855) 395-5560  
Fax: (708) 429-7125

**FLORIDA BRANCH**

10599 NW 67th Street  
Tamarac, FL 33321  
Tel: (954) 724-5214  
Fax: (954) 337-0222

**WWW.THUNDERGROUP.COM**

Melamine Dinnerware • Asian Cookware • Asian Tableware • Bakeware & Supplies • Bar Supplies • Catering & Buffetware

• Food Preparation • Gas & Electric • Janitorial • Kitchen Utensils • Professional Cookware • Table Top Services • Signage

• Shelving • Worktable • Melamine Dinnerware • Asian Cookware • Asian Tableware • Bakeware & Supplies • Bar Supplies

• Catering & Buffetware • Food Preparation • Gas & Electric • Janitorial • Kitchen Utensils • Professional Cookware • Table

Top Services • Signage • Shelving • Worktable • Melamine Dinnerware • Asian Cookware • Asian Tableware • Bakeware

& Supplies • Bar Supplies • Catering & Buffetware • Food Preparation • Gas & Electric • Janitorial • Kitchen Utensils • Professional

Cookware • Table Top Services • Signage • Shelving • Worktable • Melamine Dinnerware • Asian Cookware • Asian Tableware

Tableware • Bakeware & Supplies • Food Preparation • Gas & Electric • Janitorial • Kitchen Utensils • Professional Cookware

• Kitchen Utensils • Professional Cookware • Table Top Services • Signage • Shelving • Worktable • Melamine Dinnerware

• Asian Cookware • Asian Tableware • Bar Supplies • Catering & Buffetware • Food Preparation • Gas & Electric • Janitorial

& Electric • Janitorial • Kitchen Utensils • Professional Cookware • Table Top Services • Signage • Shelving • Worktable

Melamine Dinnerware • Asian Cookware • Asian Tableware • Bakeware & Supplies • Bar Supplies • Catering & Buffetware

• Food Preparation • Gas & Electric • Janitorial • Kitchen Utensils • Professional Cookware • Table Top Services • Signage

**USD \$60.00 • email: sales@thundergroup.com**

THUNDER GROUP IS NOT RESPONSIBLE FOR PRINTING ERRORS.  
PRICE MAY CHANGE WITHOUT NOTICE.



SURCHARGE WILL APPLY